

Hywind Scotland Pilot Park Decommissioning Programme

| | | |
|--|--|--|
| <p>Title:</p> <p>Hywind Scotland Pilot Park Decommissioning Programme</p> | | |
| <p>Document no.:</p> <p>GEN-HYS-00004</p> | | <p>Project:</p> <p>Hywind Scotland Pilot Park</p> |

| | |
|---|---|
| <p>Classification:</p> <p>Open</p> | <p>Distribution:</p> <p>According to distribution list</p> |
| <p>Expiry date:</p> | <p>Status:</p> <p>Final</p> |

| | | |
|---|-----------------------------------|------------------|
| <p>Distribution date:</p> <p>3rd May 2022</p> | <p>Rev. no.:</p> <p>01</p> | <p>Copy no.:</p> |
|---|-----------------------------------|------------------|

| |
|---|
| <p>Author(s)/Source(s):</p> |
| <p>Subjects:</p> <p>Decommissioning Programme</p> |

| | |
|---|------------------------|
| <p>Prepared by (Organisation unit / Name):</p> <p>Matthew Bramwell, O&M Maria Pagla, Asset Management Mark Batterton, Finance & Controls</p> | <p>Date/Signature:</p> |
| <p>Responsible (Organisation unit/ Name):</p> <p>Maria Pagla, Asset Management</p> | <p>Date/Signature:</p> |
| <p>Recommended (Organisation unit/ Name):</p> <p>Polly Haslam, Consent Manager</p> | <p>Date/Signature:</p> |
| <p>Approved by (Organisation unit/ Name):</p> <p>Matthew Bramwell General Manager Hywind Scotland Pilot Park</p> | <p>Date/Signature:</p> |

Decommissioning Programme for
Hywind Scotland Pilot Park

Doc. No.
GEN-HYS-00004

Valid from

Rev. no.
01

Table of contents

| | | |
|--------------|--|-----------|
| 1 | Introduction | 4 |
| 2 | Executive Summary | 5 |
| 3 | Background information | 5 |
| 3.1 | Site layout | 6 |
| 3.2 | Current adjacent facilities | 9 |
| 3.3 | Site characteristics | 11 |
| 3.3.1 | Metoccean characteristics | 11 |
| 3.3.2 | Bathymetry | 11 |
| 3.3.3 | Sea-bed conditions | 11 |
| 3.4 | Shipping and navigation | 11 |
| 3.5 | Commercial fisheries | 12 |
| 3.6 | Protected sites | 12 |
| 4 | Equipment to be decommissioned | 13 |
| 4.1 | Introduction | 13 |
| 4.2 | Hywind units | 14 |
| 4.3 | Mooring lines | 14 |
| 4.4 | Anchors | 14 |
| 4.5 | Infield cables | 15 |
| 4.6 | Export cable | 17 |
| 5 | Scope of decommissioning | 17 |
| 6 | Emergency Response | 25 |
| 7 | Environmental Impact Assessment | 25 |
| 8 | Consultations with interested parties | 25 |
| 9 | Costs and Financial security | 26 |
| 10 | Schedule | 26 |
| 11 | Project management and verification | 27 |
| 11.1 | Review process | 27 |
| 12 | Sea-bed clearance | 27 |

Decommissioning Programme for
Hywind Scotland Pilot Park

Doc. No.
GEN-HYS-00004

Valid from

Rev. no.
01

1 Introduction

Equinor has through Hywind (Scotland) Limited (HYSL) received full planning permission for onshore works and marine licence for offshore works for the “Hywind Scotland Pilot Park Project” (HYS) in 2015. Hywind (Scotland) Limited is currently owned by Equinor (75 %) and Masdar (25 %). Equinor will act as the Operator of HYS for both the construction and operation phase of the project.

The wind farm consists of 5 floating turbines moored to the seabed by three anchors each, four infield cables and one export cable connecting the wind farm to Peterhead Grange substation (Figure 1-1).

This document presents the Decommissioning Programme for the offshore elements of HYS and has been prepared according to the requirements as provided by BEIS under Section 105 of the Energy Act 2004. This Decommissioning Programme is applicable to all offshore components of the wind farm including the wind turbines, substation, foundations, export and inter-array cables, scour protection and cable protection, if required.

HYS has a technical design lifetime of 20 years and it is assumed that the timing, methods and costs associated with decommissioning will have developed significantly in this time. This document is based on current technology and practices where the final decommissioning plan will consider future developments. The actual methods, durations and costs remain uncertain at this stage in the process. The programme will, hence, be reviewed towards the end of the lifetime of the project to reflect best practice at the time and the results of any surveys undertaken at the site. The decommissioning procedure will also be subject to the award of a new Marine Licence by the Marine Scotland.

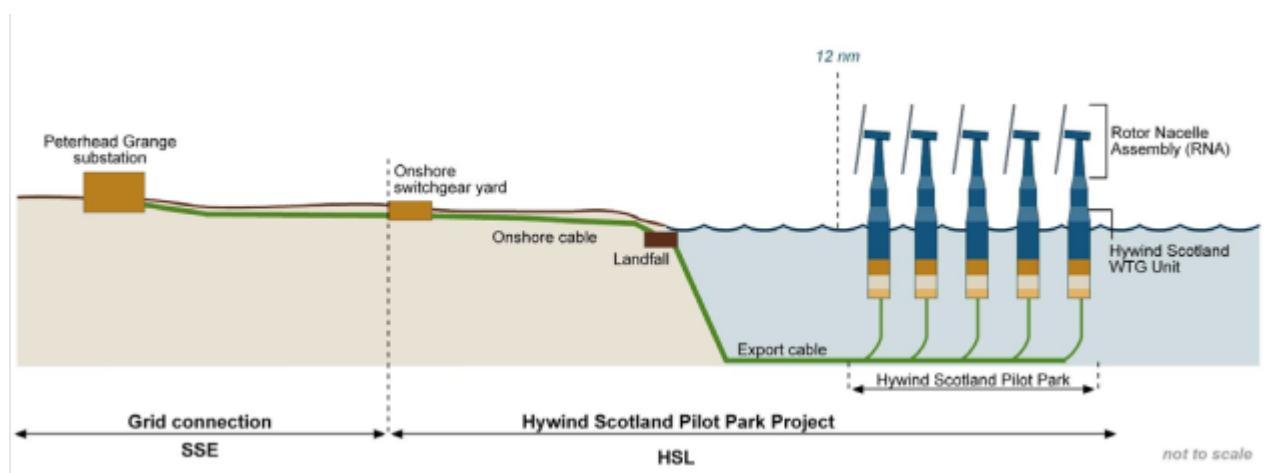

Figure 1-1: Illustration of the key components of the Hywind Scotland Pilot Park Project

Decommissioning Programme for
Hywind Scotland Pilot Park

Doc. No.
GEN-HYS-00004

Valid from

Rev. no.
01

2 Executive Summary

The Energy Act 2004 requires preparation and implementation of a decommissioning programme for Hywind Scotland Pilot Park (HYS). This document constitutes the preliminary decommissioning programme for the offshore components of the project, which will be updated and further developed before the actual decommissioning will take place.

The programme is informed and supported by the Environmental Impact Assessment (EIA) carried out for HYS. The resulting Environmental Statement (ES) provide detailed analysis of the baseline physical, biological and human environment. The assessment of the impact of the project on receptors and stakeholders considers decommissioning activities which are consistent with those presented in this document.

The decommissioning programme for HYS will follow regulations and best practice with a principle of minimising the impact on the marine environment caused by the work and any items left in place. The base case for the Hywind Scotland decommissioning is that all equipment installed offshore will be removed, however this shall be subject to further environmental assessment and feasibility studies if the assessment determines that the base case would cause greater seabed damage, then the scope of decommissioning shall require review with respect to the available technology, regulations and best practice at the time.

The wind farm opened in October 2017 and has a design life of 20 years. The decommissioning is therefore scheduled for Q2/Q3 2038 and operations at site are expected to be completed within a window of five months.

3 Background information

HYS is located at Buchan Deep, approximately 25 km off the shore of Peterhead in Aberdeenshire, Scotland. The wind farm will consist of five wind turbines on floating foundations with a total capacity of 30 MW. The project has a technical design lifetime of 20 years.

- 5 Floating Wind Turbines (FWTs)
- ~ 25km of export cable
- A network of ~8.5km of infield cables
- 15 mooring chains (3 per FWT) and 15 suction anchors (3 per FWT)

Details of the site layout are detailed in section 3.1.

This preliminary decommissioning programme is informed and supported by the Environmental Impact Assessment (EIA) carried out for HYS. The resulting Environmental Statement (ES) ¹ provides detailed analysis of the baseline physical, biological and human environment.

¹ http://marine.gov.scot/datafiles/lot/hywind/Environmental_Statement/Environmental_Statement.pdf

Decommissioning Programme for
Hywind Scotland Pilot Park

Doc. No.
GEN-HYS-00004

Valid from

Rev. no.
01

3.1 Site layout

The site layout will be as shown in Figure 3-1 and Figure 3-2.

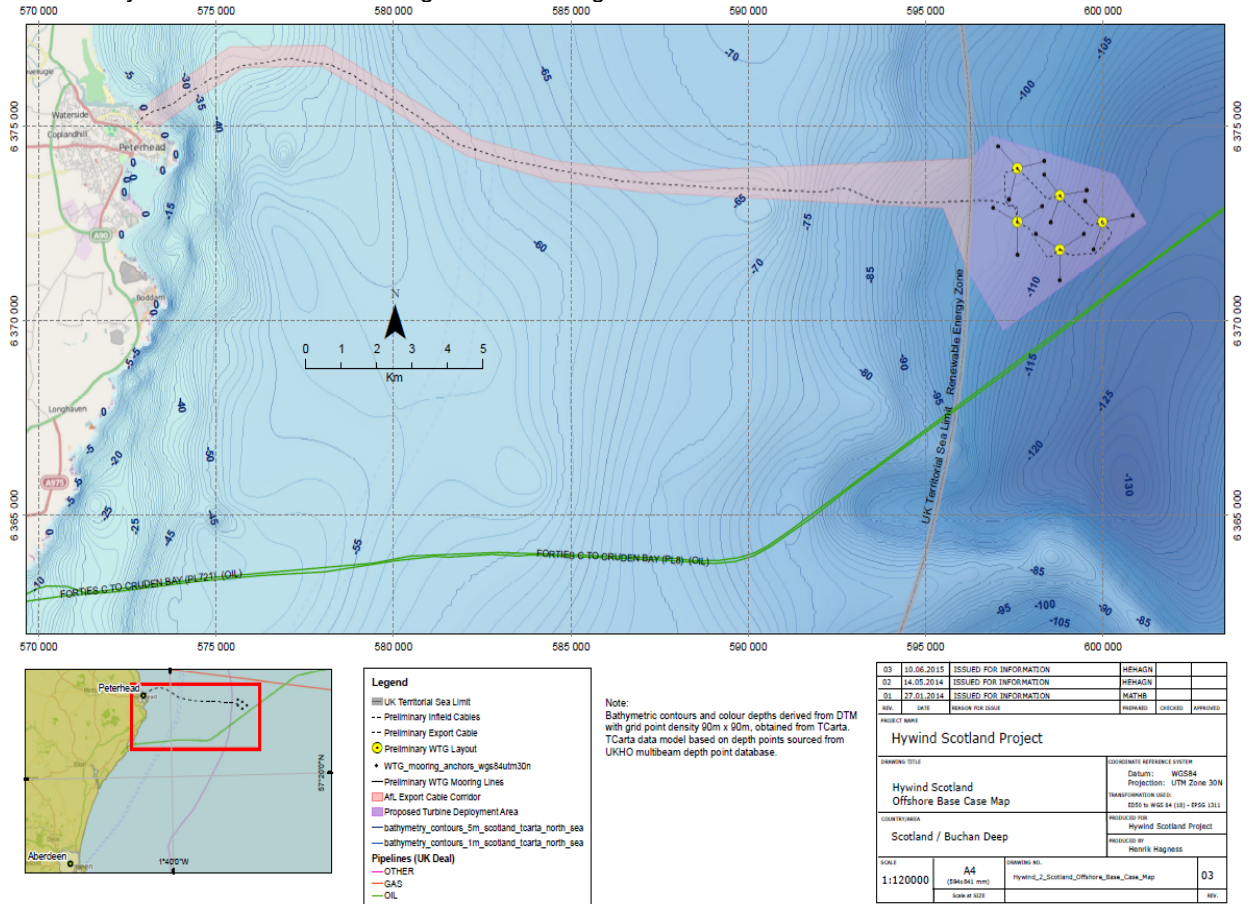

Figure 3-1 Site layout of Hywind Scotland Pilot Park

Hywind Scotland Offshore Wind Farm Operated by Equinor

Decommissioning Programme for
Hywind Scotland Pilot Park

Doc. No.
GEN-HYS-00004

Valid from

Rev. no.
01

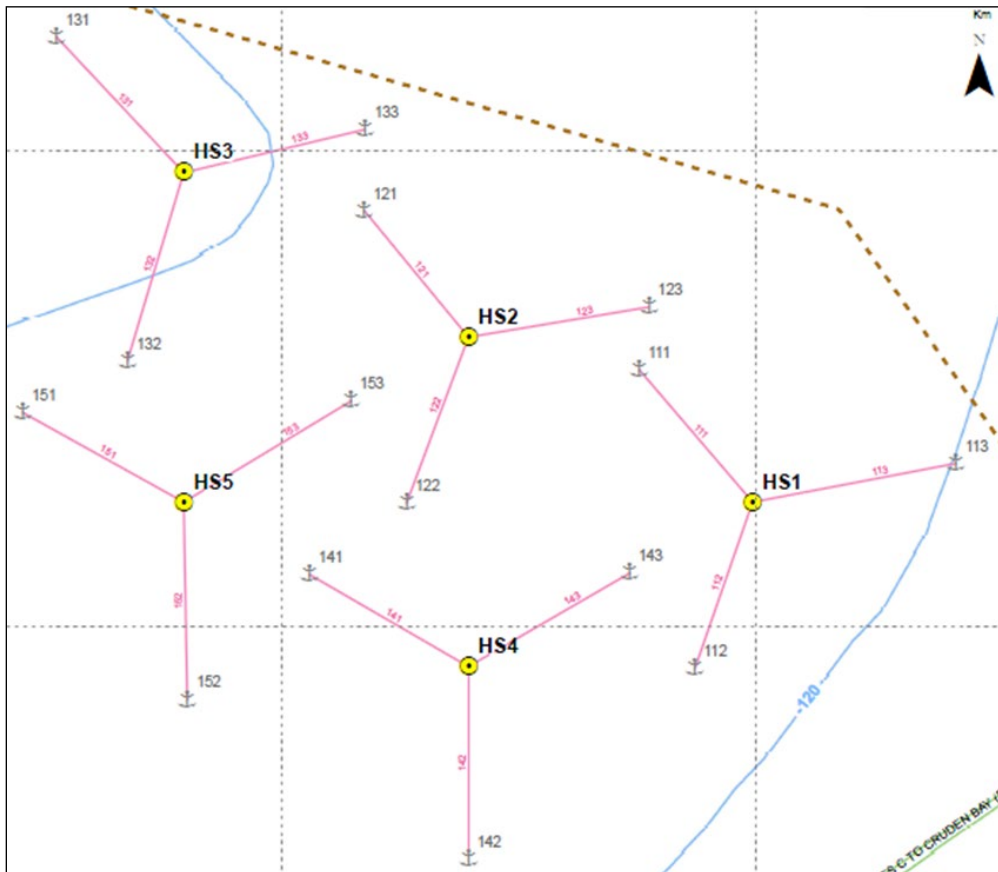

| WTG name | Easting | Northing | LAT | LON |
|----------|---------|-----------|---------------|--------------|
| HS1 | 599 985 | 6 372 522 | 57° 29.056' N | 1° 19.937' W |
| HS2 | 598 785 | 6 373 215 | 57° 29.445' N | 1° 21.120' W |
| HS3 | 597 584 | 6 373 908 | 57° 29.834' N | 1° 22.305' W |
| HS4 | 598 785 | 6 371 829 | 57° 28.699' N | 1° 21.154' W |
| HS5 | 597 584 | 6 372 522 | 57° 29.088' N | 1° 22.338' W |

| Anchor ID | WTG | Easting | Northing | Depth (m) |
|-----------|-----|------------|--------------|-----------|
| 111 | HS1 | 599 504.58 | 6 373 079.69 | 112 |
| 112 | | 599 739.59 | 6 371 822.65 | 114 |
| 113 | | 600 847.16 | 6 372 685.22 | 117 |
| 121 | HS2 | 598 345.57 | 6 373 748.57 | 106 |
| 122 | | 598 524.48 | 6 372 518.73 | 108 |
| 123 | | 599 551.92 | 6 373 344.31 | 111 |
| 131 | HS3 | 597 047.44 | 6 374 477.81 | 100 |
| 132 | | 597 346.34 | 6 373 118.34 | 104 |
| 133 | | 598 351.62 | 6 374 088.97 | 106 |
| 141 | HS4 | 598 116.10 | 6 372 217.25 | 106 |
| 142 | | 598 784.53 | 6 371 019.42 | 111 |
| 143 | | 599 467.79 | 6 372 223.94 | 113 |
| 151 | HS5 | 596 904.88 | 6 372 898.85 | 102 |
| 152 | | 597 597.99 | 6 371 689.58 | 105 |
| 153 | | 598 289.36 | 6 372 945.35 | 107 |

Hywind Scotland
Offshore Wind Farm
Operated by Equinor

Decommissioning Programme for
Hywind Scotland Pilot Park

Doc. No.
GEN-HYS-00004

Valid from

Rev. no.
01

Figure 3-2: Positions of turbines and anchors

Decommissioning Programme for
Hywind Scotland Pilot Park

Doc. No.
GEN-HYS-00004

Valid from

Rev. no.
01

3.2 Current adjacent facilities

The BP Forties crude oil pipeline system passes the area 1 km to the south of the turbine deployment area. There are several existing cables in the vicinity of the turbine deployment area and export cable corridor, including one cable along the export cable route for which it has not been possible to identify the owner. Two active and one inactive at sea disposal sites are located adjacent to the export cable corridor close to shore. All current adjacent facilities are shown in Figure 3-3.

There is currently a plan to install a high voltage interconnector cable crossing Hywind Scotland export cable. Planned to be in production 2023/24. Crossing and technical specification yet to be approved, on approval consideration for decommissioning method to be confirmed.

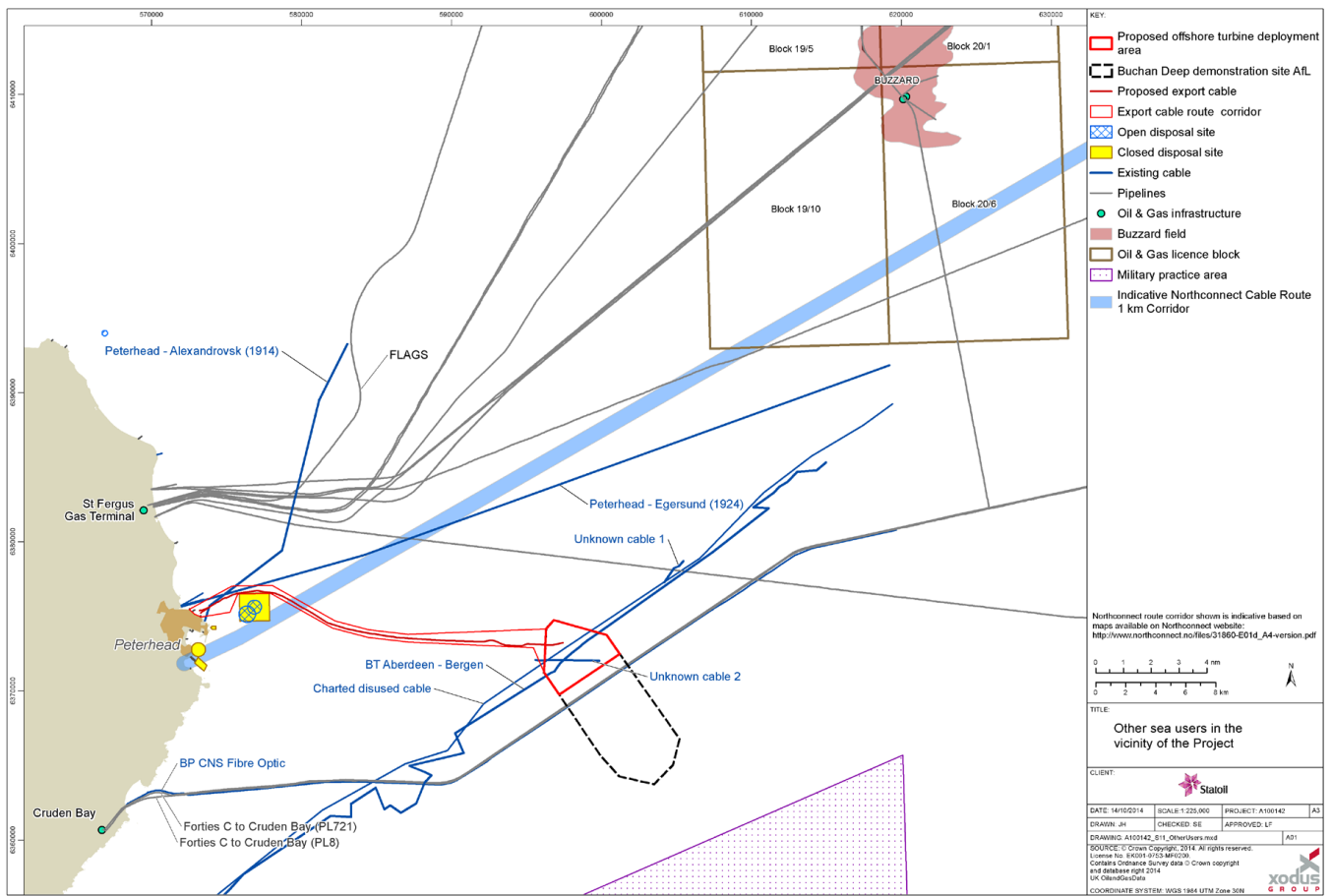

Figure 3.3: Current adjacent facilities to the Hywind Scotland Pilot Park Project.

3.3

Decommissioning Programme for
Hywind Scotland Pilot Park

Doc. No.
GEN-HYS-00004

Valid from

Rev. no.
01

Decommissioning Programme for
Hywind Scotland Pilot Park

Doc. No.
GEN-HYS-00004

Valid from

Rev. no.
01

3.4 Site characteristics

3.4.1 Metocean characteristics

The metocean characteristic for HYS has been set out in Table 3-1.

Table 3-1: Metocean characteristics at the site of HYS

| | |
|--|--------------|
| Estimated average wind speed | 10.1m/s |
| Estimated average significant wave height (Hs) | 1.8 m |
| Water depth range | 100-120 m |
| Current speed, surface | ≈ 0-150 cm/s |
| Current speed, -55 m | ≈ 0-135 cm/s |
| Current speed, 3 m above seabed | ≈ 0-87 cm/s |

3.4.2 Bathymetry

Water depths along the cable export corridor range between approximately 100 m at the turbine deployment area to 14 m at landfall where the export cable is connected to the onshore cable (HDD exit point). The seabed slopes gradually from the turbine deployment area to a depth of 20 m at less than 1 km from the landfall. Further towards shore the seabed gradient becomes steeper. The general inclination of the sea floor along the cable route ranges between 0 and 3°. Near the cable landfall, the slope increases and reaches a maximum of just above 15°. In general, an inclination above 8° is only observed very close to the landing point.

3.4.3 Sea-bed conditions

In the wind farm area, the seabed surface is covered by a relatively thin silty sand layer (Holocene deposit). Below the surface sand a layer of very soft to firm clay is present (Witch Ground Fm). This layer extends to approximately 15-25m below seabed. Below the Witch Ground formation Stiff to hard clay is present (Wee Bankie Fm).

The surficial sediment along the export cable route predominantly comprises sand and gravel. The sand layer is thicker at some sections along the cable route (pockets). Below the upper sand clay or till is generally present and at a small section close to shore bedrock are believed to outcrop the seabed.

Mega ripples and sand waves are present in the wind farm area, and mega ripples are also locally present along the cable route.

3.5 Shipping and navigation

Section 15 of the HYS ES provides a detailed overview of current shipping and navigation activities in the vicinity of HYS. A summary of this is presented below.

The HYS area and the immediate surrounding area are used by transiting merchant vessels, with approximately two-thirds associated with the oil and gas industry. Many of these vessels are using the onshore bases at Peterhead Port and

Decommissioning Programme for
Hywind Scotland Pilot Park

Doc. No.
GEN-HYS-00004

Valid from

Rev. no.
01

Aberdeen Harbour. There is also some fishing vessel activity in Buchan Deep, both from vessels steaming on passage and vessels engaged in fishing with most of the activity being from Scottish vessels. There is limited recreational vessel activity in the vicinity of the Project due to its offshore location; however, there are occasional transits by yachts crossing the North Sea which pass in the vicinity of HYS, for example en route to and from Peterhead marina.

3.6 Commercial fisheries

Section 14 of the HYS ES provides a detailed overview of current commercial fisheries activity in the vicinity of HYS. A summary of this is presented below.

Low level demersal fisheries targeting haddock, Norwegian lobster and squid are dominant in the turbine deployment area. There is also a low level of pelagic fisheries in the turbine deployment area. Scallop dredging is the fishery of highest economic value in the export cable corridor. Creels targeting crab and lobster and hand lining for mackerel also take place in the export cable corridor and fishing intensity increases closer to the shore. Vessels fishing the inshore area operate out of local ports.

3.7 Protected sites

There are currently no Special Areas of Conservation (SACs) designated under the EU Habitats Directive within 150 km of the Project, and there are no Marine Protected Areas (MPAs) designated under the Marine (Scotland) Act 2010 in the close vicinity of the Project area. The nearest is the Turbot Bank MPA, located approximately 18 km to the east of the turbine deployment area and is designated for the protection of sandeels.

The Southern Trench area, a 25 km-wide area off the southern coast of the outer Moray Firth between Cullen and almost as far south as Peterhead, is proposed as a potential Marine Protected Area (MPA). This is located adjacent to the turbine area (Figure 3-4). The proposed cable route passes through the southern extremities of this proposed nature conservation MPA, however, there are no MPA specific benthic features of interest present in this section.

Decommissioning Programme for
Hywind Scotland Pilot Park

Doc. No.
GEN-HYS-00004

Valid from

Rev. no.
01

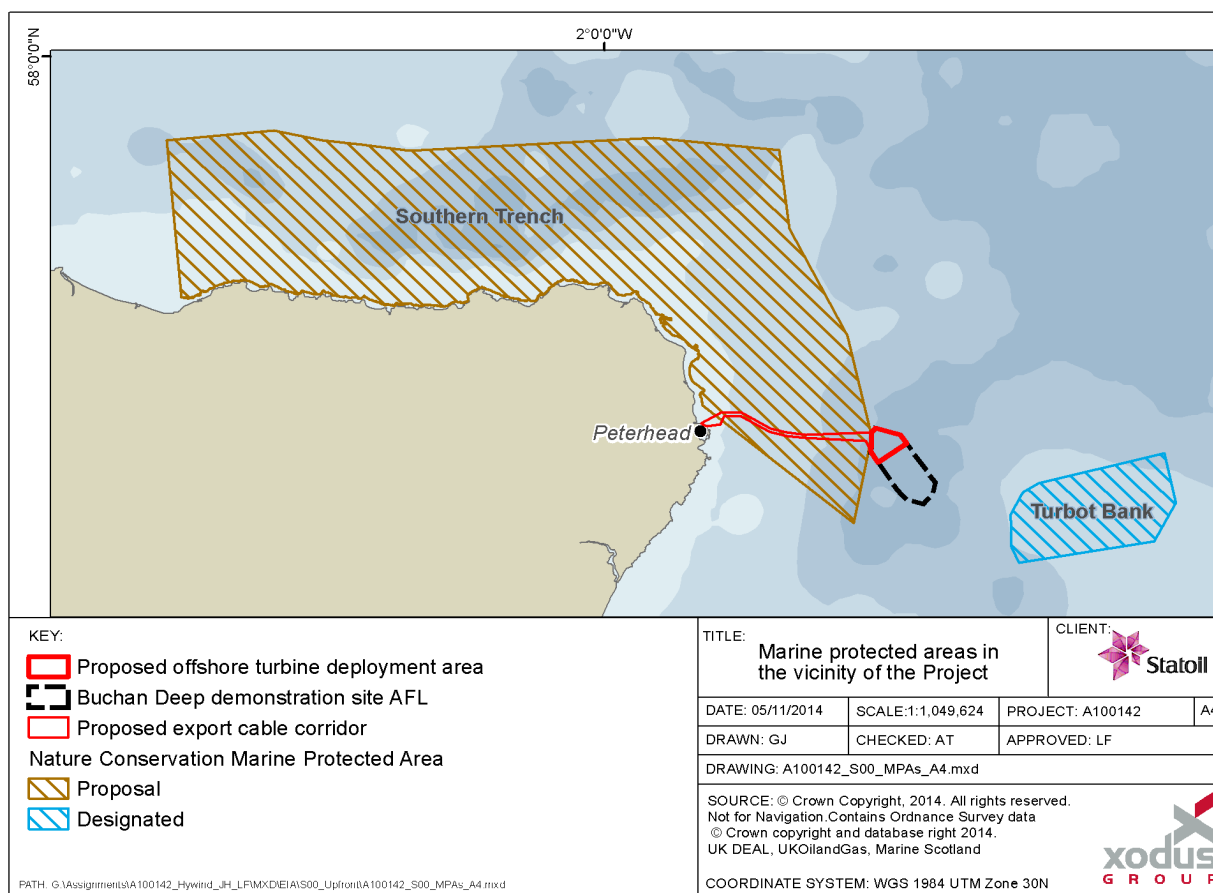

Figure 3-4: Marine Protected Areas in the vicinity of Hywind Scotland Pilot Park Project.

4 Equipment to be decommissioned

4.1 Introduction

At the end of Hywind Scotland wind farm operational life (2038), the base case is for the removal of all components in the reverse order to which they were installed.

This would involve the removal of the following:

- 5 floating Hywind units that consist of a 6 MW turbine on a floating spar buoy
- 15 mooring lines and 15 anchors (three per turbine)
- 4 infield cables
- 1 export cable (consisting of a static cable with a short dynamic cable between the static end and one of the turbines (HS5))

Decommissioning Programme for
Hywind Scotland Pilot Park

Doc. No.
GEN-HYS-00004

Valid from

Rev. no.
01

4.2 Hywind units

The Hywind units are floating structures consisting of standard wind turbine on a spar buoy type substructure. The substructure is 91meter high and will have a draft of approximately 78 meters. The substructure is made of steel and is be partly filled with ballast water and solid ballast.

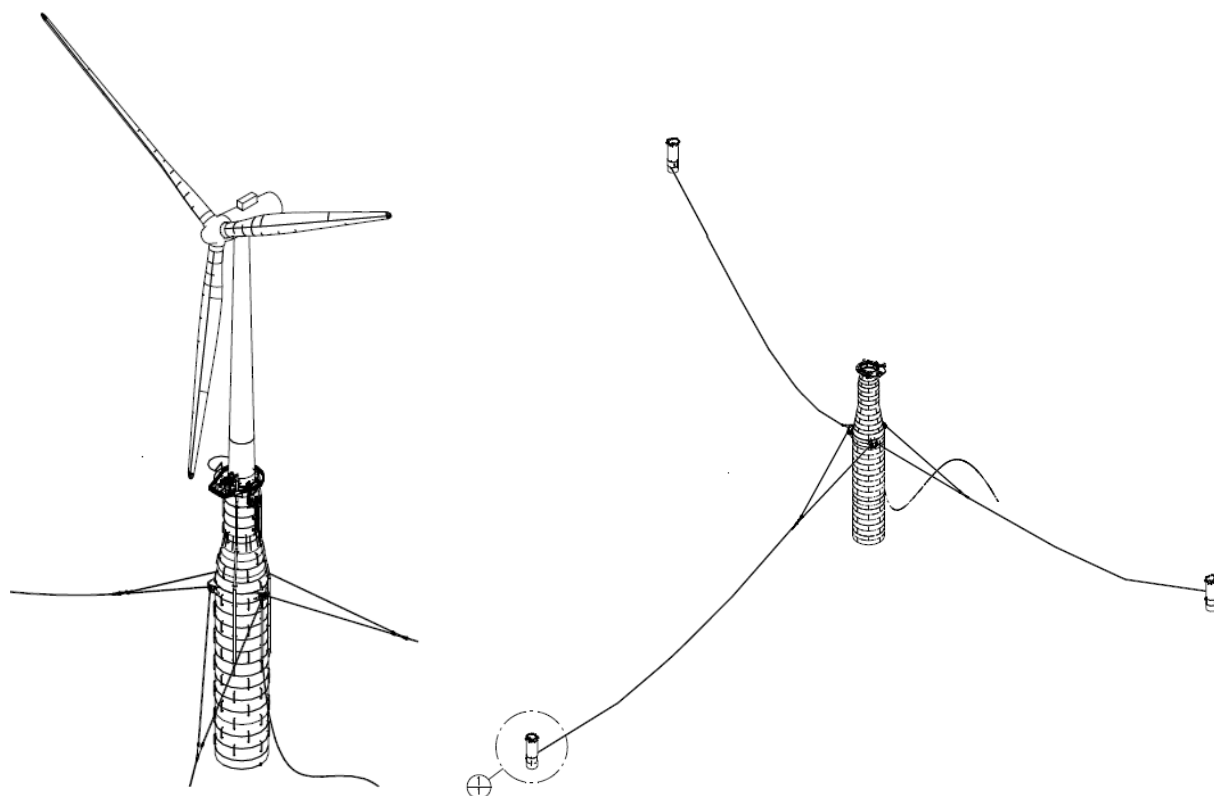

Figure 4-1: Hywind unit and mooring system

4.3 Mooring lines

There are three mooring lines per Hywind unit, leading to a total of 15 mooring lines (Figure 4-1). The mooring line lengths are ranging from 700 to 900 meters each and consisting of offshore grade studless mooring chains. Chain link dimensions are between 132 and 148 mm in diameter.

4.4 Anchors

There are three anchors per Hywind unit, leading to a total of 15 anchors. The anchors are suction bucket anchors, 5m in diameter and 16m in height (Figure 4-2). They are made of steel and have a total weight of about 100 tonnes per anchor. After installation, the top of the anchors will protrude 1.5 m above the seabed. Installation aids on top of the anchors will add a height of 1.7 m to the structures.

Decommissioning Programme for
Hywind Scotland Pilot Park

Doc. No.
GEN-HYS-00004

Valid from

Rev. no.
01

It is the base case that the suction anchors shall be removed, however, this shall be subject to an Environmental Impact Assessment.

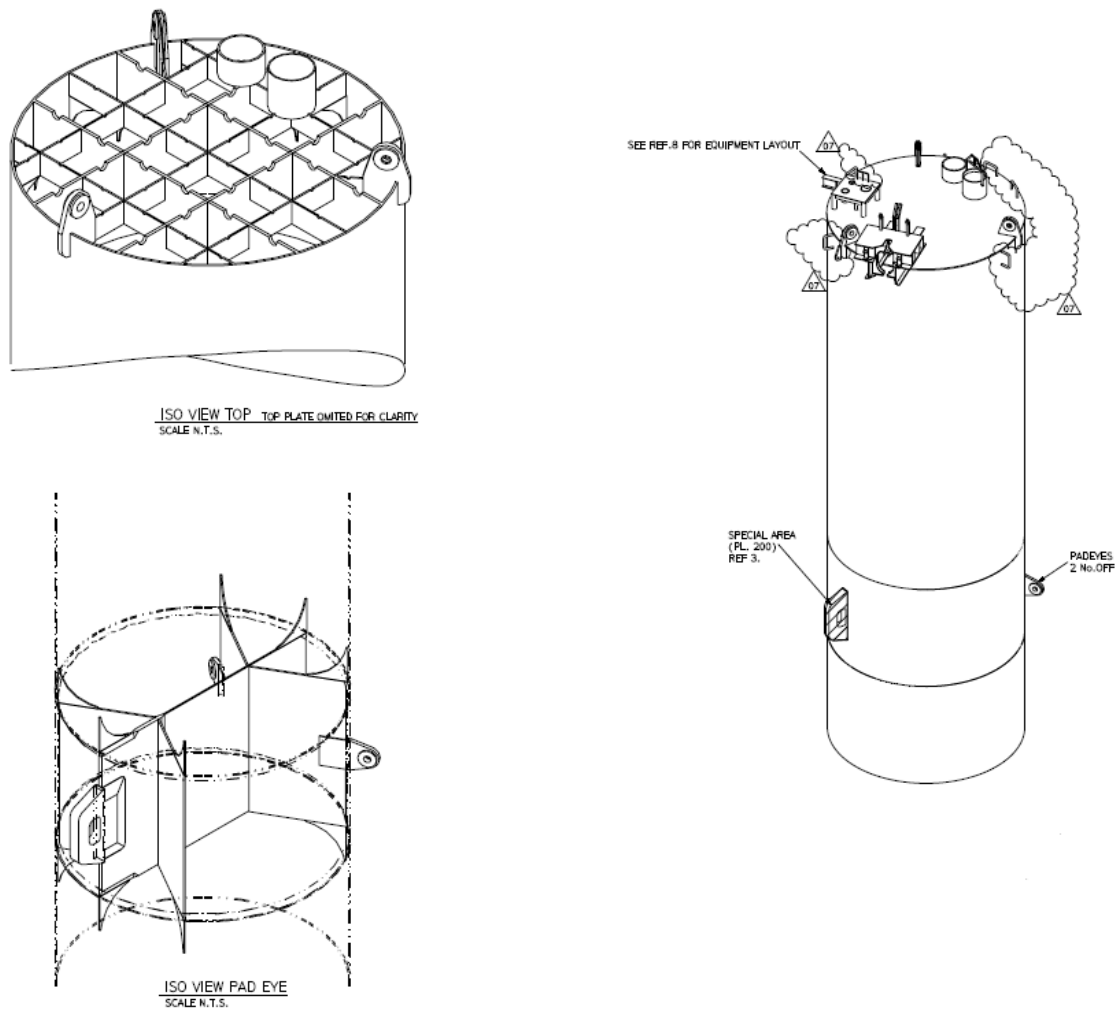

Figure 4-2: ISO view of suction anchors, including stiffeners

4.5 Infield cables

The Hywind Scotland Turbines are interconnected by four infield cables. The total length of the four infield cables is approximately 8,500m and the diameter are 169 mm. The infield cables are a combination of dynamic and static sections.

There is approximately 5,500m on the seabed which is secured by way of trenching, rock dumping and mattresses. It is the base case that all of the infield cables shall be removed, however, this shall be subject to an Environmental Impact Assessment, with specific consideration for the static sections of infield cables.

Decommissioning Programme for
Hywind Scotland Pilot Park

Doc. No.
GEN-HYS-00004

Valid from

Rev. no.
01

It is expected that all of the removed cables, and associated infield cable equipment, shall be recycled.

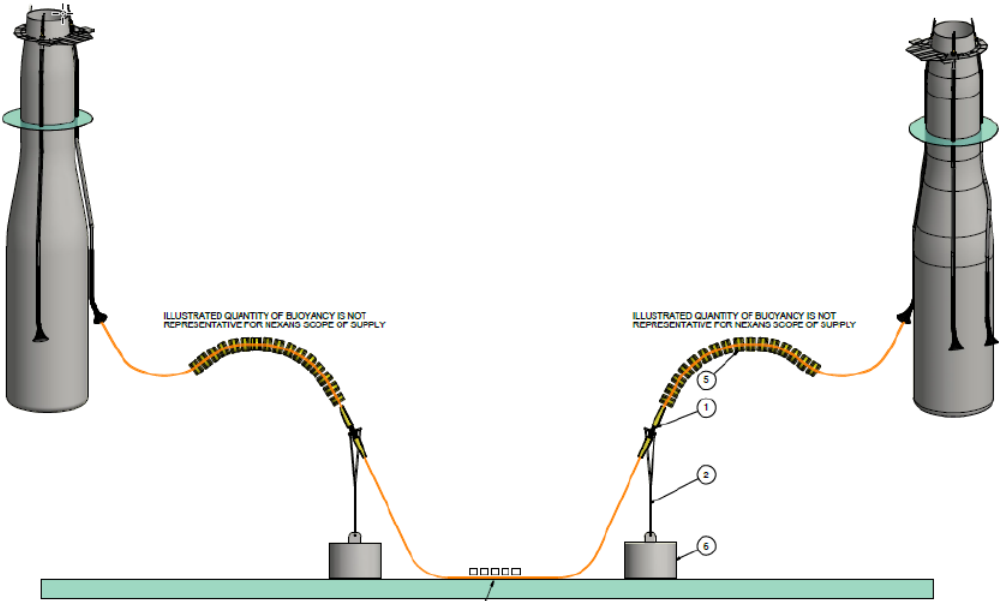
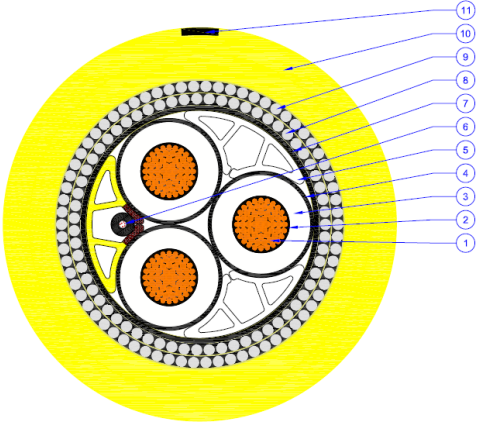

Figure 4-3: Infield Cable Layout



| | | | | |
|------|------|--|--------------------|-------------------|
| 11 | | BLACK STRIPE, APPROX. 13 mm WIDTH | - | - |
| 10 | 2 | OUTHER SHEATH (YELLOW), HE 6063 | 22 | 169 |
| 9 | 70 | ARMOUR WIRE ROUND (WITH BITUMEN) | 5 | - |
| 8 | 63 | ARMOUR WIRE ROUND (WITH BITUMEN) | 5 | - |
| 7 | | INNER SHEATH | 2.2 | 103 |
| 6 | | FO CABLE 48 SM FIBRES | - | 10 |
| 5 | 3 | PROFILED PE FILLER | - | - |
| 4 | | INSULATION SCREEN, SEMICONDUCTIVE, LE 0592 | - | 45.5 |
| 3 | | INSULATION, LS 4201 S | 8.0 | - |
| 2 | | CONDUCTOR SCREEN, SEMICONDUCTIVE, LE 0592 | - | - |
| 1 | 3 | CONDUCTOR 400mm ² CU | - | 23.5 |
| POS. | QTY. | DESCRIPTION | NOM. THICKNESS, mm | NOM. DIAMETER, mm |

Figure 4-4: Cross section of the infield cables

Decommissioning Programme for
Hywind Scotland Pilot Park

Doc. No.
GEN-HYS-00004

Valid from

Rev. no.
01

4.6 Export cable

The length of the export cable is approximately 27.5km including an approximately 500m dynamic section towards HS5. The diameter of the static part of the cable is 115mm and the diameter of the dynamic section of the export cable is 169mm, the same as the infield cables. The cross section of the infield cables is provided in the Figure 4-5.

4.6

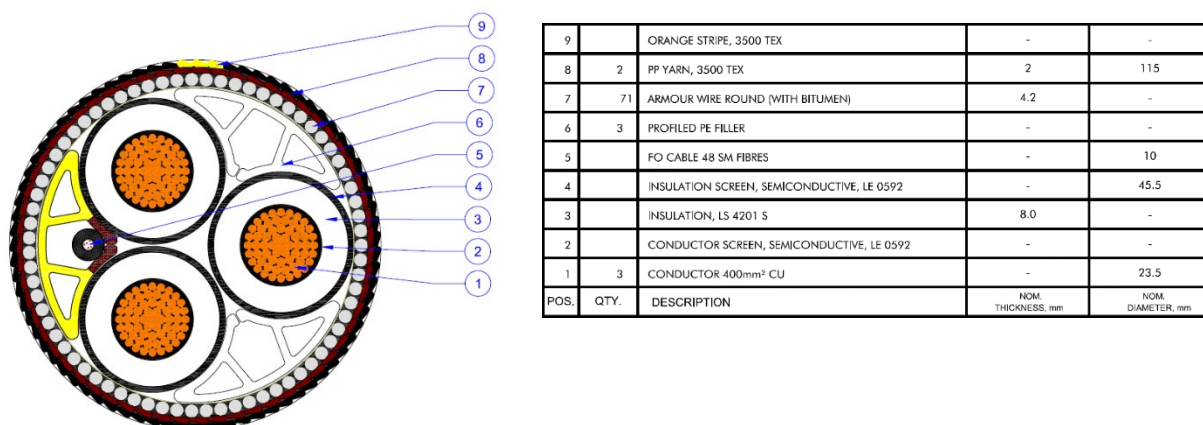

Figure 4-5: Cross section of the export cable

It is the base case that all of the export cables shall be removed, however, this shall be subject to an Environmental Impact Assessment. Please refer to Appendix 'Overview cable alignment sheets and subsea rock installation'.

It is expected that all of the removed cables, and associated cable equipment for the dynamic section from HS5, shall be recycled.

5 Decommissioning Scope of Work

This section details the options available for decommissioning, including but not limited to the base case, and the proposed measures for dealing with the major components.

5.1 Decommissioning Options

As described in earlier sections of this document, the base case is for complete removal of all equipment in 2038. It should be considered however, that depending on the integrity of the equipment and power prices, alternative options may be sought.

Decommissioning Programme for
Hywind Scotland Pilot Park

Doc. No.
GEN-HYS-00004

Valid from

Rev. no.
01

5.1.1 Re-powering

The technical integrity of the FWTs and all associated equipment shall be verified for the purposes of extending the life of the asset.

This would require considerations including the Operations and Maintenance (O&M) costs vs. the power prices at the time to proposed for decommissioning.

The principle of re-powering leans on that applied for Oil & Gas installations that have operated beyond the originally intended operational life.

For this to be a viable option, there would be various consenting conditions that would need to be met.

5.1.2 New Wind Farm

By the nature of floating wind, the ease with which FWTs be towed away lends to the idea that higher capacity turbines could be towed to site, in doing so utilising the existing mooring and cable infrastructure.

Although not currently possible, advancements in technology may make this a viable option in the future. Furthermore, there would be various consenting conditions that would need to be met.

5.1.3 Run-to-failure

The technical integrity of the FWTs and all associated equipment shall be verified for the purposes of running to failure.

In principle, each of turbines would be operated until it was no longer economically viable to operate, at which point decommissioning would default the base case as further described in this document.

For this to be a viable option, there would be various consenting conditions that would need to be met.

5.2 Decommissioning Programme

Applying the principles that all equipment will be removed, the following section details the work required to remove each of the major components installed offshore at Hywind Scotland.

The following figures detail the equipment to be decommissioned as part of the turbine, mooring system, and infield cables.

Decommissioning Programme for
Hywind Scotland Pilot Park

Doc. No.
GEN-HYS-00004

Valid from

Rev. no.
01

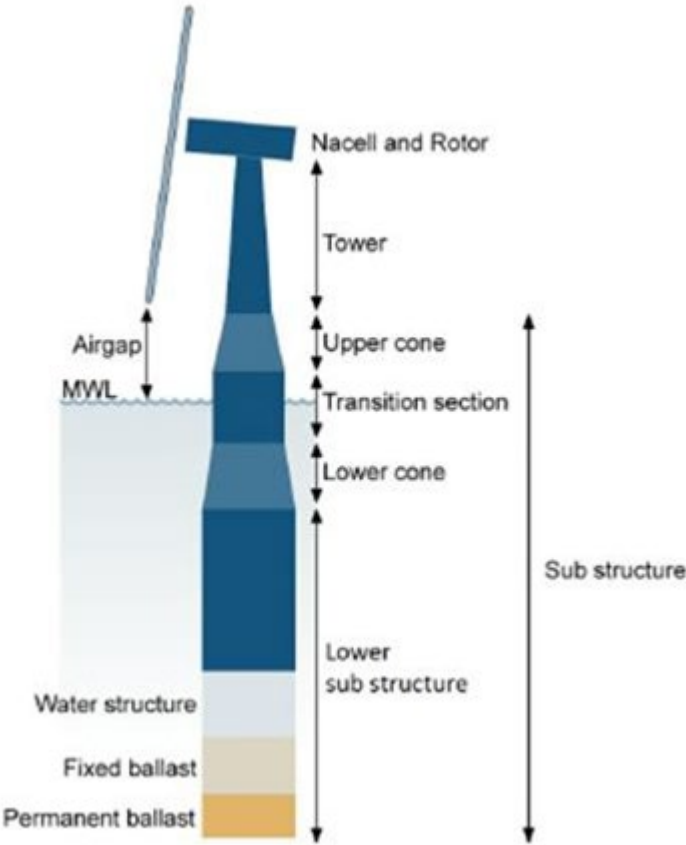

Figure 3: FWT equipment to be Decommissioned

Decommissioning Programme for
Hywind Scotland Pilot Park

Doc. No.
GEN-HYS-00004

Valid from

Rev. no.
01

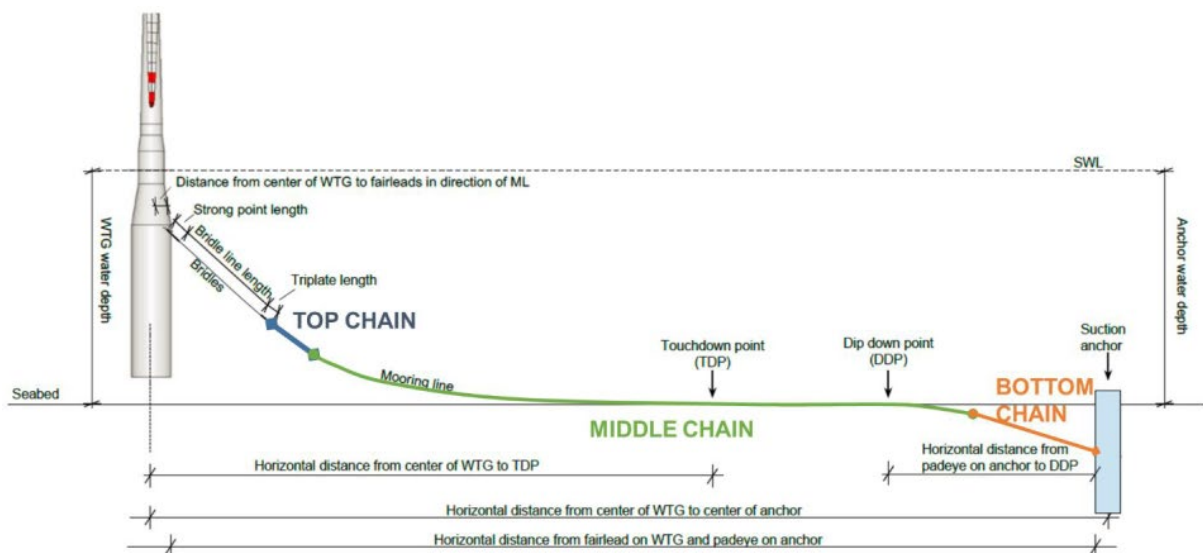

Figure 4: Mooring System to be Decommissioned

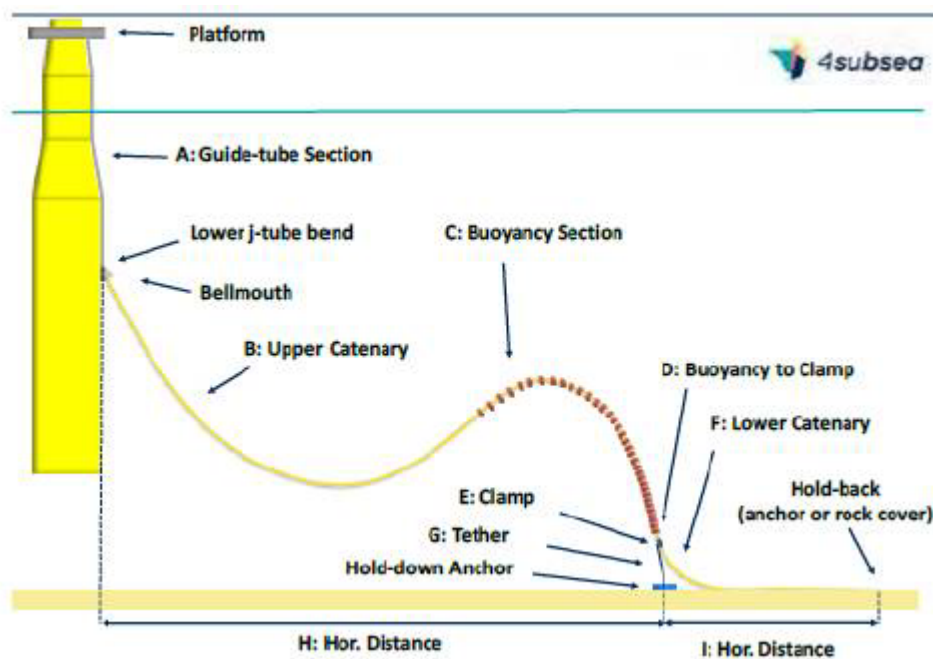

Figure 5: Infield Cables to be Decommissioned

5.2.1 Preparatory work

The preparatory work is likely to include

- Towing points to be inspected and certified to allow for towing;
- Field survey to verify the status of cables specifically as to whether any spanning exists;
- De-energize and isolate from the grid;

Decommissioning Programme for
Hywind Scotland Pilot Park

Doc. No.
GEN-HYS-00004

Valid from

Rev. no.
01

- Mobilise offshore construction vessel with cable pulling winch, min 250T crane and ROV capability;
- Install temporary power generators and temporary fuel tanks onto FWTs to allow for the continued operation of safety critical systems.

5.2.2 Floating Wind Turbines

The turbines shall be disconnected structurally and electrically in the reverse order to which they were installed; HS1, HS4, HS2, HS3 and HS5.

- Install pull in winch on turbine;
- Electrically disconnect HV cable from the turbine, cut of cable end connectors and seal the cable ends with end-seals;
- Use pull-in head to lower the cable to seabed;
- Connection of towing lines (post removal of mooring lines);
- Mobilise towing vessels (spread) to site and tow to Stord, as per figure 8, for recycling / disposal according to section 5.3.

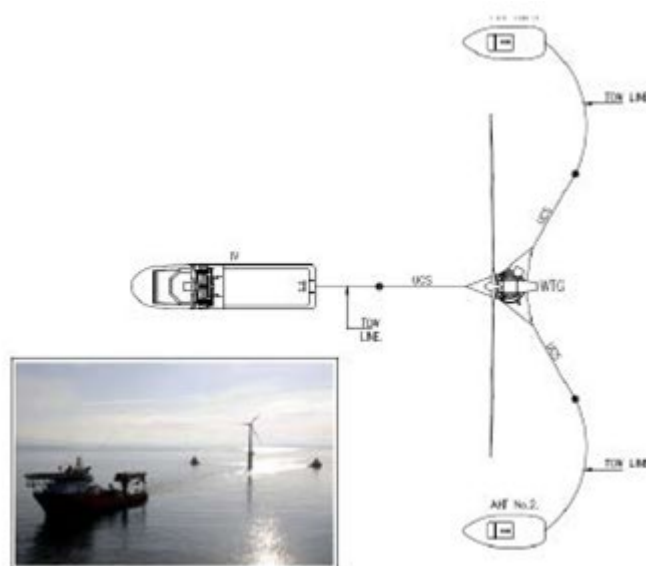

Figure 6: FWT Towing Spread

5.2.3 Mooring systems

The mooring systems consist of the mooring chains and suction anchors.

The equipment shall be removed as follows:

- Disconnection of the mooring line from the turbine connections at the mooring strong point and fairlead chain stoppers;
- Disconnection of the mooring chains from the suction anchors;
- Retrieve the mooring lines to the vessel for recycling as per section 5.3; and
- Retrieve the suction anchors from the seabed for recycling as per section 5.3.

5.2.4 Infield Cables

Decommissioning Programme for
Hywind Scotland Pilot Park

Doc. No.
GEN-HYS-00004

Valid from

Rev. no.
01

The infield cables require disconnection from two turbine locations before it can be lowered to the seabed. Cables are connected as follows:

- HS4 to HS5;
- HS1 to HS4;
- HS2 to HS3;
- HS3 to HS5.

The infield cables are dynamic at each end, with a static section in the middle which had a target burial depth of 1.0m during construction. The process for retrieval shall be as follows:

- Offshore construction vessel retrieves cable end to deck;
- Cable to be pulled in using a winch, with the central section of cable subject to water jetting to expose the buried sections;
- Cables taken to shore for recycling as per section 5.3.

5.2.5 Export Cable

The initial section of export cable from HS5 is dynamic. The dynamic section shall be removed as follows:

- Offshore construction vessel retrieves cable end to deck;
- Cable to be pulled in using a winch (offshore construction vessel), with the buried sections of cable subject to water jetting to expose;
- Transition from infield cable to export cable shall allow for confirmation that the static export cable is now being removed;
- Continue to retrieve the cable using water jetting techniques to excavate the buried cable.

Ideally, the cable shall be retrieved into a cable drum to reduce the time spent in retrieving the cable. The cable shall then be taken to shore for recycling / disposal as per section 5.3.

It is the base case that the export cables shall be removed, however, this shall be subject to an Environmental Impact Assessment. Further consideration shall also need to be given if any new crossings of the cable have been installed by the time Hywind Scotland is to be decommissioned.

5.2.6 Rock Dumps

Rock dumping was completed along sections of the export cable as defined in the below overview cable alignment sheets and subsea rock installation; Please refer to separate appendix entitled 'overview cable alignment sheets and subsea rock installation'.

Decommissioning Programme for
Hywind Scotland Pilot Park

Doc. No.
GEN-HYS-00004

Valid from

Rev. no.
01

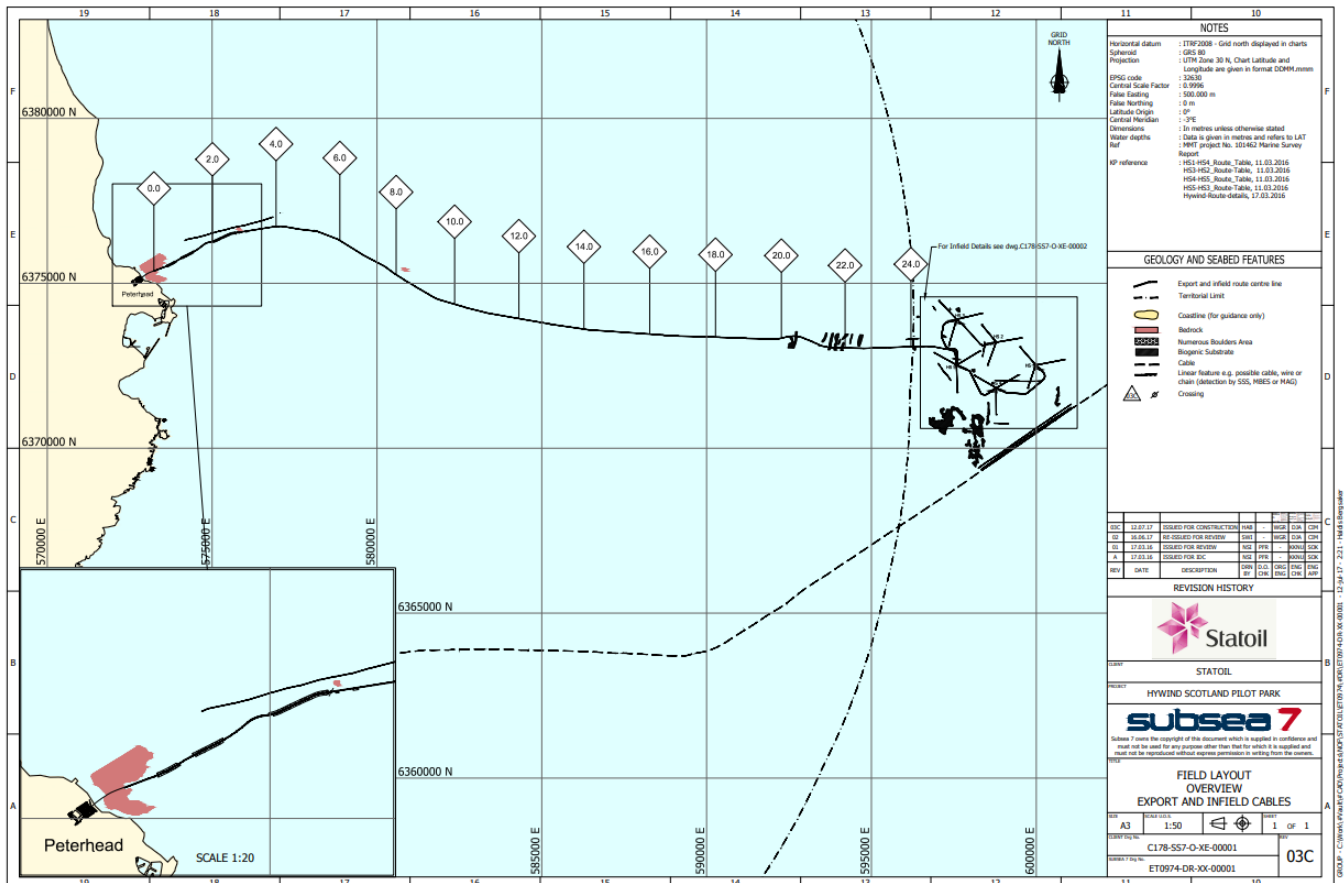

It is the base case that the rock dumps shall be removed as far as reasonably practicable, however, this shall be subject to an Environmental Impact Assessment.

5.2.7 Post De-commissioning Work

On completion of the decommissioning activities, a survey of the site will be conducted to identify the status of the site.

5.3 Waste Management

On completion of equipment removal from Hywind, the hierarchy for equipment shall be as follows:

- Re-use
- Recycle;
- Dispose.

If the alternative option for decommissioning Hywind Scotland was opted for (re-use), then the planned waste management would need to be revised, to heavily focus on re-using materials rather re-cycling or disposing.

Decommissioning Programme for
Hywind Scotland Pilot Park

Doc. No.
GEN-HYS-00004

Valid from

Rev. no.
01

The following table details the major components, materials, preparatory work and planned waste management.

| Component | Preparty Work | Planned Waste Management |
|-----------------------|--|--------------------------|
| FWT Tower | Break down into manageable sizes for transport – tower made up of four bolted sections | Recycle |
| Substructure ballast | Materials to be removed from substructure | Dispose |
| Mooring Chains | Break down into manageable / transportable sizes | Recycle |
| Suction Anchors | Break down into manageable / transportable sizes | Recycle |
| Power Cables (copper) | Copper to be stripped | Recycle / Dispose |
| Blades/Rotor | - | Recycle / Dispose |
| Nacelle | Major components to be removed as far as practicable | Recycle / Dispose |
| Lubricants | - | Dispose |

Table 1: Hywind Scotland – Waste Management

All items will be delivered to an EU certified waste handling facility for re-use/recycling. The Hywind units will be towed to an approved decommissioning yard for further dis-assembly, before the materials are sent for re-use/recycling. All licences shall be acquired prior to commencing work. If re-use/recycling is not possible, incineration with energy recovery will be considered, whereas disposal will be the last option. Equinor is committed to ensuring that all waste is handled in a proper manner and according to best practice at the given time. There are currently several suitable yards in Norway to perform the decommissioning work ADRS Gulen, AF Offshore Decom, Green Yard, Kvaerner Stord, Lutelandet Industrihamn and Norscrap West.

5.4 Alternative Decommissioning Programme

At the final review of this programme will be conducted prior to decommissioning, with a review of the Environmental Impact Assessment and latest technologies to also be completed. There is the potential that the removal of these items may cause additional damage to the seabed, and or removal involves higher HSE risks. An assessment will therefore be made to conclude on whether to leaving the buried items in place, or removal is the most appropriate option. When making a decision on the decommissioning option, this will be based on tests set out by international conventions (IMO standards) and involve at least one of the five situations:

- The installation or structure will serve a new use;
- Entire removal would involve extreme cost;
- Entire removal would involve an unacceptable risk to personnel;
- Entire removal would involve an unacceptable risk to the marine environment;

Decommissioning Programme for
Hywind Scotland Pilot Park

Doc. No.
GEN-HYS-00004

Valid from

Rev. no.
01

6 Emergency Response

In general, any emergency situations during the decommissioning phase will be handled similarly as during the installation activities or operational phase.

The procedure for decommissioning of the Hywind Scotland infrastructure will be very similar to the installation activities, in most cases just performed in reverse. Similar safety measures as during installation will be introduced in order to reduce the risks, e.g. for loss of the WTG during de-tensioning of the anchor lines and during tow. Below is an overview of some of these mitigating measures:

- The Marine contracts for de-hook up of the offshore mooring system and towing the Floating Wind Turbines (FWT) to shore will be based on the DNV-GL offshore standards
- A Marine Warranty Surveyor (MWS) will be appointed and all operational documentation developed by the marine contractor will have to be accepted by MWS and Certificates of Approval will be issued by Marine Warranty Surveyor before any marine operation will start
- Additional 3rd party verification tasks may be identified by Equinor
- A de-commissioning operation is not time critical for the project and all marine operations will take place during summer season with calm weather.

In case of an incident, the vessel captain(s) will have the primary responsibility to report an incident both to the Coastguard Operations Centre, and to Equinor's 2nd line (ERT) emergency preparedness organisation.

Equinor 2nd line Emergency (ERT) preparedness organisation in Great Yarmouth will perform the necessary reporting to the Marine Accident Investigation Branch (MAIB) and to the Health and Safety Executive (HSE) – ref. RIDDOR (Reporting of Injuries, Diseases and Dangerous Occurrences Regulations 2013).

The above notification routines may change in the years up to the decommissioning phase starts, if so, the necessary emergency plans will be updated accordingly.

7 Environmental Impact Assessment

Hywind Scotland's Environmental Statement considered the potential impacts of decommissioning. No significant impacts were identified.

Impacts of potential rock dumping during decommissioning will be synonymous with those during construction and installation phase of the project. When the project nears the decommissioning phase and once more detail is available on the specific activities associated with decommissioning, more detailed assessment of environmental impacts will be undertaken as part of the Decommissioning Programme.

8 Consultations with interested parties

Equinor regards consultation with stakeholders as an essential element to the successful development of HYS. Through the development of the project, from the initial Environmental Assessment, to the Supplementary Environmental

Decommissioning Programme for
Hywind Scotland Pilot Park

Doc. No.
GEN-HYS-00004

Valid from

Rev. no.
01

Information as well as during post-consent, the principle of open consultation and transparency of information has been followed. Equinor intends to continue with this approach for the lifetime of the project including the decommissioning phase.

Consultation on the draft decommissioning programme previous revision (03) has been undertaken, with all relevant stakeholders invited to comment including:

- Aberdeenshire Council
- Chamber of Shipping
- Civil Aviation Authority
- CHC Scotia Helicopter Services
- Department for Business, Energy and Industrial Strategy
- Joint Nature Conservation Committee
- Historic Environment Scotland
- Marine Scotland – Compliance
- Marine Scotland – Science
- Marine Scotland – Licensing Operations Team
- Maritime and Coastguard Agency
- Northern Lighthouse Board
- National Air Traffic Services (EnRoute)
- Royal Yacht Association (Scotland)
- Relevant Harbour Authority
- Scottish Environment Protection Agency
- Scottish Fisherman's Federation
- Scottish Natural Heritage
- Scottish Wildlife Trust
- The Crown Estate
- Transport Scotland
- UK Hydrographic Office

HYS will continue to seek the opinions of stakeholders with further consultation undertaken in the years preceding decommissioning on both the programme and any environmental assessment undertaken, in order to minimise the impact on the environment and stakeholders.

9 Costs and Financial security

Cost and financial security information is confidential and will be provided as a separate document.

10 Schedule

A full decommissioning schedule will be included in the final approved plan. An indicative schedule is included below.

The wind farm started operating 2017 and has a design life of 20 years. The decommissioning is planned to be undertaken during Q2/Q3 2038. Activities at site are assumed to be done within a window of five months. An indicative

Decommissioning Programme for
Hywind Scotland Pilot Park

Doc. No.
GEN-HYS-00004

Valid from

Rev. no.
01

schedule for decommissioning is given in Figure 10-1. Decommissioning of the WTG, tower and substructure will continue after this at the decommissioning facility. Recycling activities will also extend beyond this schedule.

| Indicative schedule for decommissioning | | 2038 | | | | |
|---|---|------|------|------|--------|-----------|
| # | Step | May | June | July | August | September |
| 1 | Isolate, disconnect and retrieve infield cables and dynamic part of the export cable. Bring to shore for recycling (possibility for reuse will be considered) | | | | | |
| 2 | Isolate, disconnect and retrieve static section of export cable. Bring to shore for recycling (possibility for re-use to be considered) | | | | | |
| 3 | Disconnect mooring lines and tow Hywind units to shore for decommissioning | | | | | |
| 4 | Disconnect mooring lines from anchors and bring on board vessel. Bring to shore for recycling (possibility for reuse will be considered) | | | | | |
| 5 | Lift suction anchors from seabed and bring onboard vessel. Bring to shore for recycling (possibility for reuse will be considered) | | | | | |

Figure 10-1: Indicative schedule for decommissioning

Please note that the base case for Hywind Scotland shall be to remove all installed equipment, however, this shall be subject to an Environmental Impact Assessment.

11 Project management and verification

This section will be further elaborated towards the final stages of the project, when an updated Decommissioning Programme is provided and consulted on based on the final decommissioning options.

11.1 Review process

Equinor proposed to undertake formal reviews of the Decommissioning Programme in consultation with the regulatory authority at the following times:

- A comprehensive review 12 - 18 months before the first security provision is due to identify any changes in assumptions on costs and risks where these might affect the size or timings of financial securities;
- From payment of first security onward an annual review will be undertaken to ensure the financial security provision is on track to meet expected cost of decommissioning. MS will be informed that high level review has been undertaken, even if no changes are deemed necessary.
- At the reasonable request of the regulatory authority.

12 Sea-bed clearance

In line with the details provided above, Equinor and Masdar are committed to covering the costs required to decommission HYS (in line with the Polluter Pays Principle) and ensuring the seabed has been cleared. Upon completion of

Decommissioning Programme for
Hywind Scotland Pilot Park

Doc. No.
GEN-HYS-00004

Valid from

Rev. no.
01

decommissioning, a survey will be undertaken to ensure that all debris related to the development of the offshore wind farm has been removed, where required. The survey will enable identification and recovery of any debris located on the seabed which may have arisen from activities related to HYS and which may pose a risk to navigation.

The required survey area will be determined during the decommissioning phase of the project, considering best practice at the time and the views of stakeholders. Equinor is aware of the guidance for oil and gas installation which specifies a 500 m radius around any installation, however, due to the smaller scale of the installations Equinor proposes a smaller radius could be used e.g. 100m around the Hywind units and at the different locations of the anchors or rock dumping has taken place. The export cable will be inspected over the lifetime and results from those inspections should be considered when planning the surveys.

Discussions will also occur on the requirement for independent, third party involvement in the surveys to provide evidence that the site had been cleared. It is likely that an independent party would conduct the surveys and provide an independent report on the findings.