

Project Title/ Location	MeyGen Tidal Energy Project, Phase 1a. Inner Sound.
Date:	21/10/2016

# MeyGen Tidal Energy Project Phase 1

## Project Environmental Monitoring Programme



This document contains proprietary information belonging to MeyGen Ltd. and/or affiliated companies and shall be used only for the purpose for which it was supplied. It shall not be copied, reproduced, disclosed or otherwise used, nor shall such information be furnished in whole or in part to third parties, except in accordance with the terms of any agreement under which it was supplied or with the prior consent of MeyGen Ltd. and shall be returned upon request.

Rev	Prepared	Sign Off	Checked	Sign Off	Approved	Sign Off	Date of Issue	Comments
1	Ed Rollings, Cara Donovan, Chris Eastham		David Taaffe		Ed Rollings		27/06/2016	MEY-1A-70-HSE-018-I-PEMP
2	Ed Rollings, Cara Donovan, Chris Eastham		David Taaffe Stephen Ward Martin Dunn		Ed Rollings		08/08/2016	MEY-1A-70-HSE-018-I-PEMP
3	Ed Rollings, Cara Donovan, Chris Eastham		Stephen ward		Ed Rollings		21/09/2016	MEY-1A-70-HSE-018-I-PEMP
4	Ed Rollings, Cara Donovan, Chris Eastham		Stephen ward		Ed Rollings		21/10/2016	MEY-1A-70-HSE-018-I-PEMP

## Table of Contents

Executive Summary .....	3
1 Introduction .....	4
2 Scope of The Project Environmental Monitoring Programme .....	5
3 PEMP Contributors.....	8
4 Communication, Roles and Responsibilities.....	9
5 Monitoring System .....	11
6 System Connection and Installation.....	30
7 Contingency Measures.....	34
8 System TestIng .....	36
9 Data Management and Reporting.....	38
10 Licences and Legal Requirements .....	41
11 Linkages with Other Conditions .....	42
12 PEMP Review and consultation.....	44
13 list of abbreviations.....	45
14 References.....	46
Figure 1: Phase 1a Infrastructure, Inner Sound, Pentland Firth.....	6
Figure 2: Key interfaces and organisation chart .....	10
Figure 3: Dual stacked Trittech Gemini vertical swath (Sparling <i>et al.</i> 2016).....	13
Figure 4: Plan view - Trittech Gemini horizontal swath (Sparling <i>et al.</i> 2016) .....	13
Figure 5: HiCUP design.....	14
Figure 6: Position of Sensors on TSS .....	15
Figure 7: PAM (black) and camera (blue) mounted on TSS leg.....	16
Figure 8: HiCUP and FLOWBEC position relative to ARL TTG .....	17
Figure 9: Imagenex orientation.....	19
Figure 10: Instrument Ping Synchronisation.....	22
Figure 11: Example of the TSS Junction Box .....	30
Figure 12: Subsea instrument connection system .....	31
Figure 13: TSS support frame for the HiCUP.....	33
Figure 14 Cross talk tests .....	36
Figure 15 PEMP Change Process.....	44
Table 1 Proposed Installation Schedule.....	7
Table 2 Proposed Commissioning Date Ranges .....	7
Table 3 Proposed Timeline for the MeyGen deployment, EK 60 management and reporting schedule.....	25
Table 4: Summary of PEMP sensors.....	26
Table 5 Proposed monitoring in relation to condition 12 of the Section 36 consent. ....	27
Table 6 Summary data outputs.....	39
Table 7 Licences .....	41
Table 8 Linkages with other conditions .....	42
Table 9 Project plans during each stage of the development process.....	43
Appendix A: Condition 12 of Section 36 consent .....	47
Appendix B: Monitoring Programme Steering Report .....	48
Appendix C: Scottish Government Demonstration Strategy Project Final Report .....	84
Appendix D: Monitoring equipment matrix .....	199

**EXECUTIVE SUMMARY**

This Project Environmental Monitoring Programme (PEMP) has been prepared by MeyGen Limited (MeyGen) to set out the proposed method for discharging the Condition 12 of the Section 36 Consent for the Development.

The document details the monitoring methods proposed for the commissioning and operational phases of the Development and how communication will be maintained between MeyGen, the Advisory Group (established in accordance with Condition 13) and the Regulators.

The PEMP will be submitted to the Scottish Ministers for their written approval, in consultation with Scottish Natural Heritage (SNH), the Advisory Group and any other ecological, or such other advisors as required at the discretion of the Scottish Ministers.

The data collected during monitoring will be used by the Advisory Group to inform decisions on each subsequent stage of the Development. Empirically measured close range encounter or passage rates may be substituted for the density inputs into collision risk models, and any measured avoidance or evasion may be translated into avoidance rates. The combination of these two factors will allow a more realistic calculation of collision risk for subsequent stages.

## 1 INTRODUCTION

The MeyGen Tidal Energy Project Phase 1 (“the Development”) received consent under Section 36 of the Electricity Act 1989 from the Scottish Ministers 9<sup>th</sup> October 2013 (“the S.36 Consent”). A Marine Licence was also received on the 31<sup>st</sup> January 2014. The Project Environmental Monitoring Plan (PEMP) is prepared to enable Condition 12 of the S.36 Consent (“the Condition”) to be discharged. The Marine Licence also refers to the PEMP, but only in relation to the Ecological Clerk of Works (ECoW). The full text of Condition 12 can be found in Appendix A, however the four main elements to be monitored are:

- a) *Hydro dynamics / benthic surveys, export cable route and turbine locations and modelling to validate EIA predictions;*
- b) *Collision / encounter interactions with the tidal turbines for diving birds, marine mammals and fish of conservation concern;*
- c) *Disturbance and displacement of birds, marine mammals and basking sharks during construction and operation. This must also link to the species protection plan for seals at haul outs; and*
- d) *Migratory salmonids*

A Monitoring Steering Report (MEY-1A-54-REP-01-D-SteeringReport v4 – see Appendix B) was produced and agreed by the Advisory Group on 23<sup>rd</sup> May 2014. This steering report provides details of the prioritisation of both receptor and potential impact, and refined the above four elements of Condition 12 to the objectives and concepts for the development of the PEMP. The report takes the lessons learnt from previous research and identifies where current and planned research will contribute to meeting the needs of the consent conditions and wider industry questions. Bringing these together, the report recommends more specific objectives and monitoring, which have been taken forward and developed for the PEMP and are appropriate for addressing the consent conditions. The scope and objectives of the PEMP are described in Section 2 below. Further details are available in the Monitoring Steering Report (see Appendix B).

The PEMP is part of a suite of documents related to the Marine Licence and S.36 Consent for the Development. The S.36 Consent stipulates that the PEMP must, so far as is reasonably practicable, be consistent with the Environmental Management Plan (EMP), the Vessel Management Plan (VMP), Construction Method Statement (CMS) and the Navigational Safety Plan (NSP). To ensure that the Development is appropriately constructed and operated, the PEMP must:

- Take into account mitigation measures to protect the environment and other users of the marine area;
- Protect the environment, and;
- Ensure appropriate and effective monitoring of the impacts of the Development.

Table 8 in Section 11 summarises the links between Marine Licence and S.36 Consent conditions and the suite of documents described above.

## **2 SCOPE OF THE PROJECT ENVIRONMENTAL MONITORING PROGRAMME**

MeyGen is committed to safeguarding the environment through the identification, avoidance and mitigation of the potential negative environmental impacts associated with the planning, construction and operation of the Development.

The principal objectives of the PEMP are to:

- Detect and quantify potential avoidance and collision rates for harbour seals, and verify and improve the accuracy of collision/encounter rate models.
- Provide sufficient monitoring data for impact assessment to allow each subsequent stage of the Development to proceed.

Whilst the principal objective is to monitor harbour seals, the technology used may be capable of monitoring other marine species, such as other marine mammal species (e.g. grey seals and harbour porpoise), fish (e.g. Atlantic salmon), and diving birds (e.g. black guillemot and shag). Gathering monitoring data on these other species will help to address the elements of Conditions 12(b) and 12(d) respectively.

The Monitoring Steering Report (MEY-1A-54-REP-01-D-SteeringReport v4 – Appendix B) concluded that:

- 1) Benthic and hydrodynamic impacts (Condition 12 (a)) were low priority for Phase 1a and will not be covered further. Opportunities with larger turbine arrays could be more relevant and possible in future phases of the project.
- 2) Disturbance and displacement impacts (Condition 12 (c)) were low priority for Phase 1a and would not be monitored directly. Opportunities with larger turbine arrays could be more relevant and possible in future phases of the project.

Construction and maintenance activities covered under the CMS and Operations and Maintenance Programme (OMP) are controlled under the EMP. The EMP includes specific mitigation and monitoring for the disturbance of marine mammals by the construction vessels (including seals at haul-outs) as referred to in Condition 12 (c).

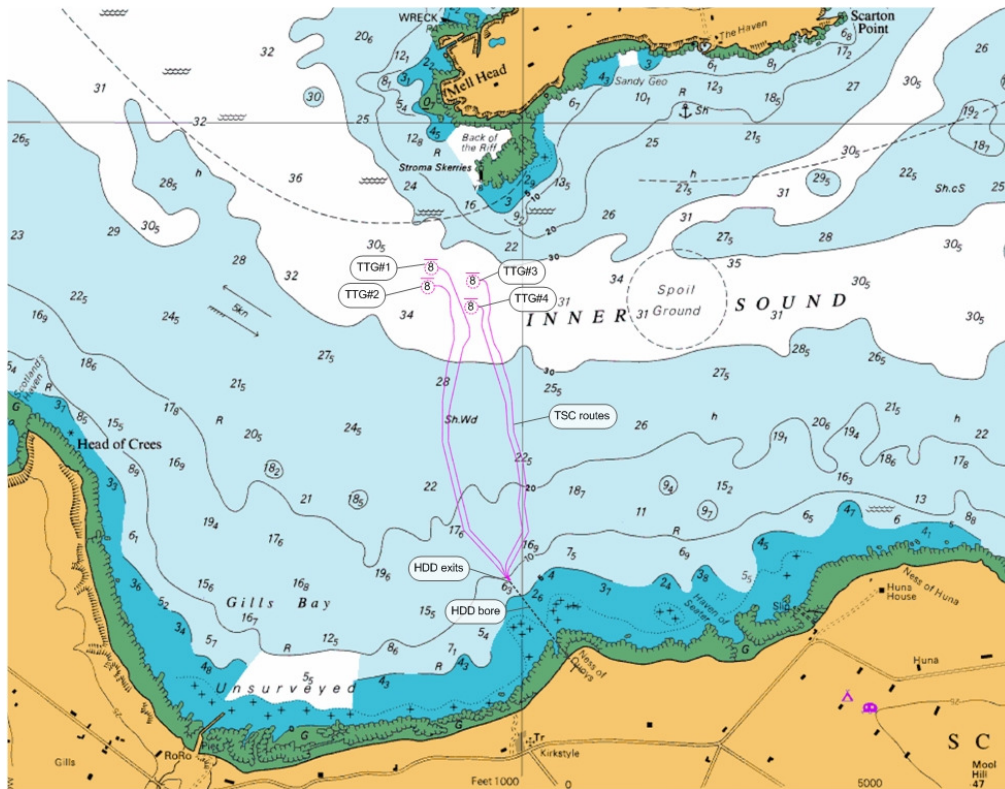
The Development will be operated, at all times, in accordance with the approved PEMP (as updated and amended from time to time). Any updates or amendments made to the PEMP by MeyGen must be submitted, in writing, by MeyGen to the Scottish Ministers for their written approval.

In addition to the consent conditions, the PEMP must relate to the Environmental Statement (ES) and Supplementary Environmental Information Statement (SEIS) with regard to the environmental management measures proposed in the ES and SEIS.

Phase 1a of the Development is a 6MW, 4 tidal turbine initial phase to be installed and operated under the restriction placed on the Development by Condition 2 of the S.36 Consent.

*Project Environmental Monitoring Programme*

This document, as agreed with the licensing authority, covers the pre- construction, construction and operation of the Phase 1a infrastructure (4 x Tidal Turbine Generators (TTG), 4 x Gravity-base Turbine Support Structures (TSS) and Turbine Submarine Cables (TSC), collectively described as “the Works” (Figure 1).



**Figure 1: Phase 1a Infrastructure, Inner Sound, Pentland Firth**

However, as identified in the Monitoring Steering Report, the focus of the monitoring will be during the operational phase. The current schedule for the installation of the four turbine support structure (TSS) and tidal turbine generator (TTG) is shown in Table 1 below. However it should be noted that these dates may be subject to change due to availability of installation windows.

*Project Environmental Monitoring Programme*

[REDACTED]	[REDACTED]	[REDACTED]	[REDACTED]	[REDACTED]
[REDACTED]	[REDACTED]	[REDACTED]	[REDACTED]	[REDACTED]
[REDACTED]	[REDACTED]	[REDACTED]	[REDACTED]	[REDACTED]
[REDACTED]	[REDACTED]	[REDACTED]	[REDACTED]	[REDACTED]
[REDACTED]	[REDACTED]	[REDACTED]	[REDACTED]	[REDACTED]
[REDACTED]	[REDACTED]	[REDACTED]	[REDACTED]	[REDACTED]
[REDACTED]	[REDACTED]	[REDACTED]	[REDACTED]	[REDACTED]
[REDACTED]	[REDACTED]	[REDACTED]	[REDACTED]	[REDACTED]
[REDACTED]	[REDACTED]	[REDACTED]	[REDACTED]	[REDACTED]
[REDACTED]	[REDACTED]	[REDACTED]	[REDACTED]	[REDACTED]
[REDACTED]	[REDACTED]	[REDACTED]	[REDACTED]	[REDACTED]
[REDACTED]	[REDACTED]	[REDACTED]	[REDACTED]	[REDACTED]
[REDACTED]	[REDACTED]	[REDACTED]	[REDACTED]	[REDACTED]
[REDACTED]	[REDACTED]	[REDACTED]	[REDACTED]	[REDACTED]
[REDACTED]	[REDACTED]	[REDACTED]	[REDACTED]	[REDACTED]

**Table 1 Proposed Installation Schedule**

The earliest and latest dates for completion of the commissioning of the four tidal turbine generators (TTG) is as follows;

[REDACTED]	[REDACTED]
[REDACTED]	[REDACTED]
[REDACTED]	[REDACTED]
[REDACTED]	[REDACTED]
[REDACTED]	[REDACTED]

**Table 2 Proposed Commissioning Date Ranges**

### **3 PEMP CONTRIBUTORS**

The PEMP has been designed in association with the following two projects:

#### **3.1 Knowledge Transfer Partnership with the University of Aberdeen**

MeyGen is involved in a 2-year Knowledge Transfer Partnership (KTP) with the University of Aberdeen (Dr Benjamin Williamson), which is run by InnovateUK.

The KTP remit is to transfer and apply the knowledge and techniques developed in the FLOWBEC project for environmental monitoring around tidal turbines to the Development. The KTP is supporting the development of monitoring equipment and techniques to gather the data required to satisfy the PEMP, and thus fulfil the requirements of Condition 2 and release the remainder of Phase 1 for installation, and support the consent of Phase 2.

The KTP includes development and deployment of the FLOWBEC monitoring platform at the MeyGen site, for baseline surveys and turbine monitoring. Although capable of monitoring mammal interactions and behaviour, the FLOWBEC platform gathers data across trophic levels (e.g. fish, seabirds, mammals) with concurrent hydrodynamic and physical data (flow speed, turbulence, visibility) to provide contextual data for the information gathered by other sensors, including Scottish Government Demonstration Strategy (SGDS) equipment (see below). The combination of animal behaviour around Phase 1a and environmental covariates will allow the investigation of mechanistic links and predictive tools to support the development of future phases. The KTP also includes system design and integration of the overall monitoring system, including the SGDS equipment, to allow the effective deployment and concurrent operation of all instruments.

#### **3.2 Scottish Government Demonstration Strategy**

The SGDS is a research programme to develop, test and deploy methods for tracking the fine scale underwater movements of marine mammals in areas of marine renewable energy development. The SGDS will also gather data to satisfy the PEMP objectives by monitoring the behaviour of marine mammals in close proximity to the MeyGen tidal array, and fulfil the requirements of Condition 2.

The programme has been led by the Sea Mammal Research Unit (SMRU) of the University of St Andrews. Development and testing was completed in phase 1 of the SGDS, resulting in a system which incorporates active acoustic monitoring (AAM), passive acoustic monitoring (PAM) and video to track multiple species in three dimensions around the tidal turbine site. Phase 2 of the SGDS will include its longer term deployment with tidal turbines (at the MeyGen site).

Both the KTP with the University of Aberdeen and the SGDS with SMRU will provide complementary data which will be used to meet the PEMP objectives, and the S.36 Consent conditions.



## **4 COMMUNICATION, ROLES AND RESPONSIBILITIES**

This section details the Development team roles, responsibilities and lines of communication during the construction and operation of the Development.

### **4.1 Responsibilities and Ownership**

MeyGen will have the ultimate responsibility for ensuring the implementation of the PEMP. The ECoW, appointed in accordance with Condition 10, will provide quality assurance and approval of the PEMP.

The ECoW's role is in place until the final commissioning of Stage 1 of the Development, the role will not continue during the operation phase. The role of managing, revising and reporting on the PEMP to Scottish Ministers and the Advisory Group during the operation phase will be held by the Head of Environment and Consents (HEC), in line with the OMP. The overlap between the ECoW and HEC during the commissioning phase will be split accordingly to maintain consistency:

- 1) Construction (including installation of the monitoring equipment) – reported by the ECoW in accordance with the CMS, EMP, VMP and NSP;
- 2) Commissioning – construction works continues, monitoring under the PEMP begins.
  - a. Construction works reported by the ECoW in accordance with the CMS, EMP, VMP and NSP.
  - b. Environmental monitoring detailed in the PEMP, managed and reported by the HEC.
- 3) Operation
  - a. Monitoring of fully operating project in line with the PEMP, managed and reported by the HEC;
  - b. Maintenance activities carried out in accordance with the OMP, EMP, VMP and NSP, managed and reported by the HEC.

Any updates to the PEMP post commissioning will require the HEC to check compliance with current legislation, consent conditions and related documents. An updated version of the PEMP will then be submitted to the Advisory Group for consultation and the Scottish Ministers for approval.

### **4.2 Organisational Chart**

The organisational chart for the PEMP is shown below in Figure 2. This chart includes how communication as part of the PEMP will be conducted in normal working procedures and in the case of emergencies. The organisation chart presents the key interfaces, lines of communication and responsibilities with regards to the flow of requirements and provision of data across the PEMP.

Project Environmental Monitoring Programme

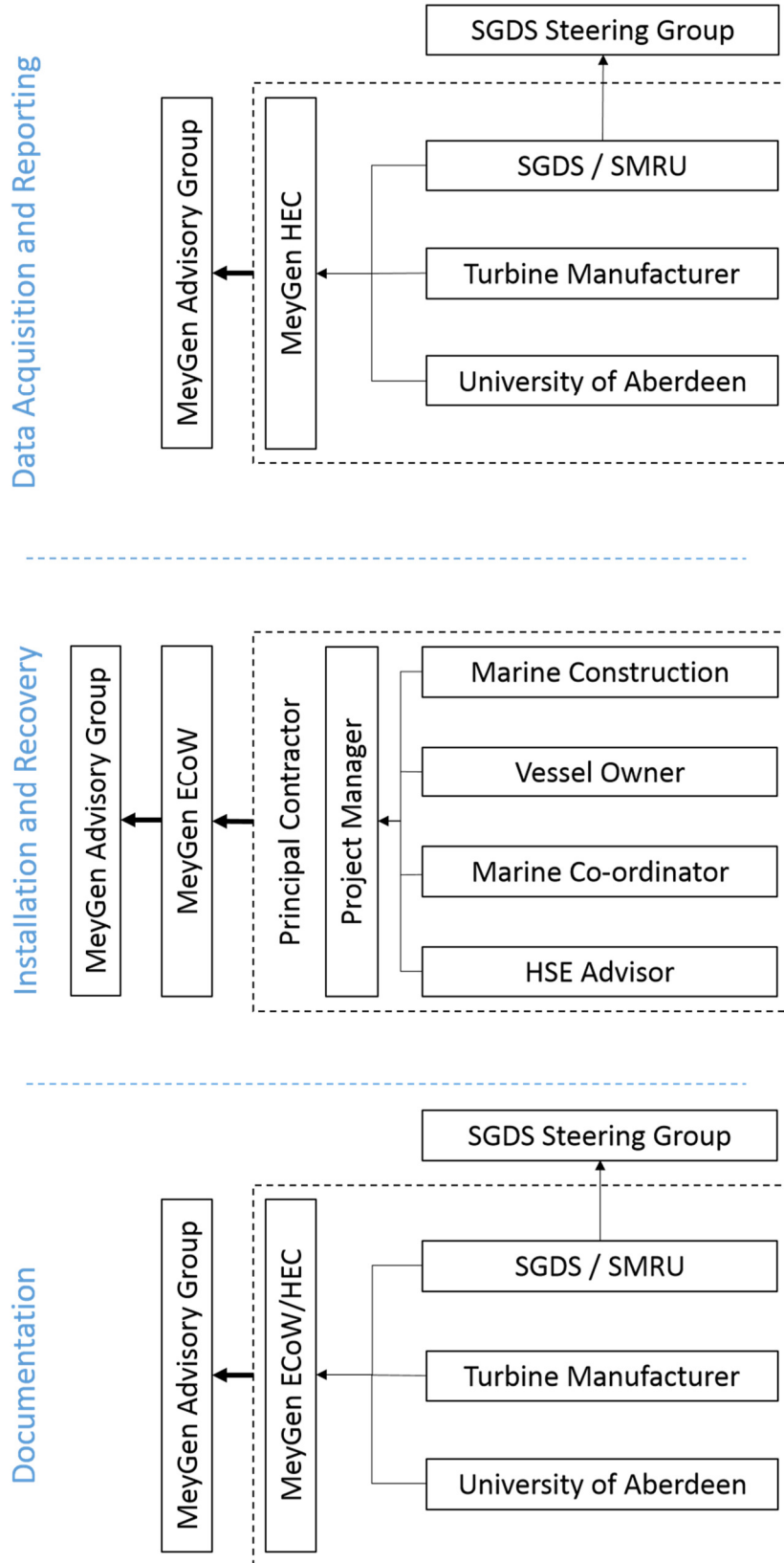


Figure 2: Key interfaces and organisation chart

## 5 MONITORING SYSTEM

The monitoring system is designed to provide high spatial and temporal resolution target tracking within the near field scale around the TTG; providing data to meet the requirements of the 2 monitoring objectives (as detailed in Section 2), namely to:

- detect and quantify potential avoidance and collision rates for harbour seals. Verify and improve the accuracy of collision/encounter rate models; and
- provide sufficient monitoring data for impact assessment to allow each subsequent stage of the Development to proceed.

Please refer to the monitoring equipment matrix in Appendix D, which sets out how each component of the monitoring system relates to the S.36 Consent.

Research and trials to date have not found a single technology that is able to provide data on marine species behaviour around, and their potential collision with, tidal turbines. The monitoring system is a combination of several different technologies that are designed to complement each other.

The monitoring system involves components from the FLOWBEC project, SGDS, MeyGen and the turbine manufacturers, as outlined below:

- 1) Multibeam sonar – SGDS;
- 2) Passive Acoustic Monitoring (PAM) – SGDS;
- 3) TSS mounted video camera – SGDS;
- 4) Harbour seal telemetry – SGDS;
- 5) FLOWBEC platform (Multibeam sonar, Multi-frequency Echosounder, Fluorometer, Acoustic Doppler Velocimeter (ADV), ADCP) – MeyGen/UoA;
- 6) TTG mounted ADCP – MeyGen/Turbine manufacturer;
- 7) TTG mounted video camera – MeyGen/Turbine manufacturer; and
- 8) Blade strain gauge – MeyGen/Turbine manufacturer.

Each technology identified above is discussed in further detail below.

The monitoring system will be linked to the Atlantis Resources Limited (ARL) TTG so that power and data will be transferred via the TSC to the shoreside Power Conversion Unit Building (PCUB) at the Ness of Quoy.

The multibeam sonar, PAM, TSS mounted video cameras, and FLOWBEC platform will be connected to the TTG cable management system (CaMS) via a TTG Junction Box mounted on the TSS (as described in Section 6.1 below). The other sensors are directly connected to the TTG nacelle.

### **5.1 Active Acoustic Monitoring (Sparling *et al.* 2016)**

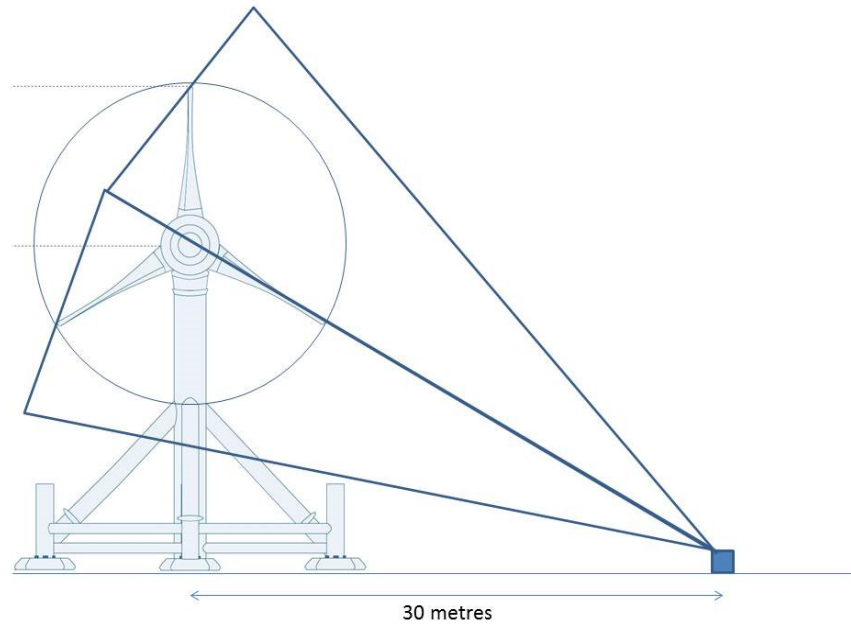
Active acoustics (sonar) can be used to track marine mammals and potentially smaller targets in the near field environment of the TTG. The SGDS project has selected 2 x Tritech Gemini multibeam sonars (720 kHz), stacked vertically (as shown in Figure 3). The Gemini unit has a horizontal and vertical swath of 120° and 20° respectively.

Previous work (Hastie 2012) reviewed a number of active sonar systems for their ability to track marine mammals at a resolution that would be suitable for this application whilst not causing an overt behavioural response from marine mammals. The Tritech Gemini was selected from that process and was tested at the SeaGen turbine in Strangford Lough Narrows, in Northern Ireland.

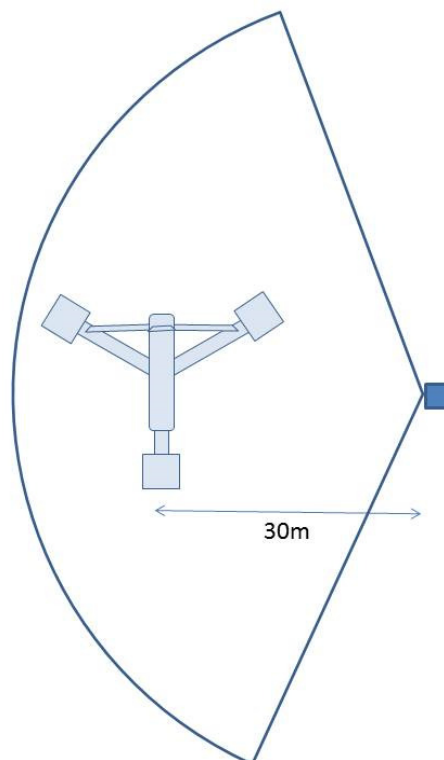
The SGDS completed trials of the Gemini units (2015), which included investigating the optimum configuration and position of sensors to cover the area around the tidal turbine. The solution recommended by SGDS is (as shown in Figure 3, Figure 4 and in more detail in Figure 8) to:

- 1) Position the Gemini units perpendicular to the ebb and flood tide facing the TTG. The horizontal swath will cover the TTG blade position for the ebb and flood tide;
- 2) Stack the Gemini units one above the other. The narrow 20° vertical swath of a single Gemini would only cover 11m (at a range of 30m). Stacking 2 units provides complete coverage of the TTG blades.

The 2 x Tritech Gemini swaths are overlapped and by measuring the ratio of the intensity of a target between the two units the depth of the target can be calculated. This allows for 3D tracking previously not possible with a single unit (only able to track in 2 dimensions). Marine mammals can be tracked around tidal turbines with good spatial resolution (sub-metre) in the X-Y plane and with an accuracy of around 1-2 m in the depth plane. So, any evasion responses largely in the horizontal plane will be detected with a good degree of accuracy although vertical responses will be associated with more error. This has obvious implications for the assessment of whether a collision has occurred; specifically, the error in depth estimation makes it unlikely that a collision can be reliably confirmed using the AAM system alone.



**Figure 3: Dual stacked Tritech Gemini vertical swath (Sparling *et al.* 2016)**



**Figure 4: Plan view - Tritech Gemini horizontal swath (Sparling *et al.* 2016)**

*Project Environmental Monitoring Programme*

Further details on the active sonar system and the trials that were carried out under the SGDS can be found in Sparling *et al.* (2016). In summary, the active sonar system provides automatic software detection and tracking of marine mammals. It allows three dimensional tracking of marine mammal targets around the turbine rotor, with identification of cetaceans versus seals possible at close range, which can also be differentiated with help of PAM. Seal species identification is unlikely. Fish and diving birds are likely to be detected also but automatic software does not yet exist so processing data for non-marine mammal targets will be labour intensive. Species identification for fish and birds is unlikely.

The Tritech Gemini will be fixed on a High Current Underwater Platform (HiCUP) designed by the SGDS (as shown in Figure 5). The HiCUP is 0.5m high, 1.8m from centre to end of each leg and weighs approximately 1200kg.

HiCUP is positioned to the side of the turbine, covering ebb/flood upstream from a single position. Partial downstream coverage may also be possible, subject to the turbine shadow and downstream turbulence.



**Figure 5: HiCUP design**

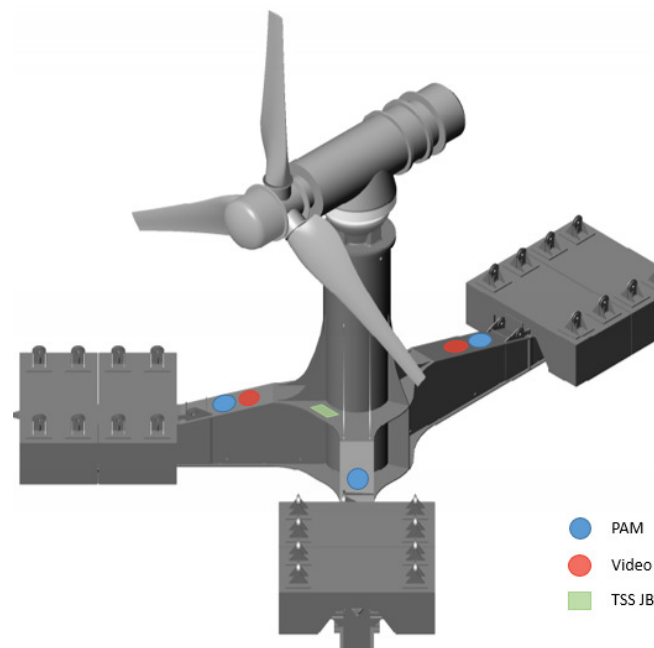
## 5.2 Passive Acoustic Monitoring

Hydrophones have been widely used to record the clicks and whistles of Harbour porpoise and other vocalising cetaceans in the marine environment. Software (PAMGuard) has been developed to detect and classify clicks and whistles.

The SGDS has been testing a PAM system that uses multiple hydrophone arrays so that vocalisations can be tracked in 3D. With a single cluster of hydrophones, the bearing of the sound can be measured but not range. By using multiple clusters of hydrophones, range can also be determined from the data (Sparling 2016).

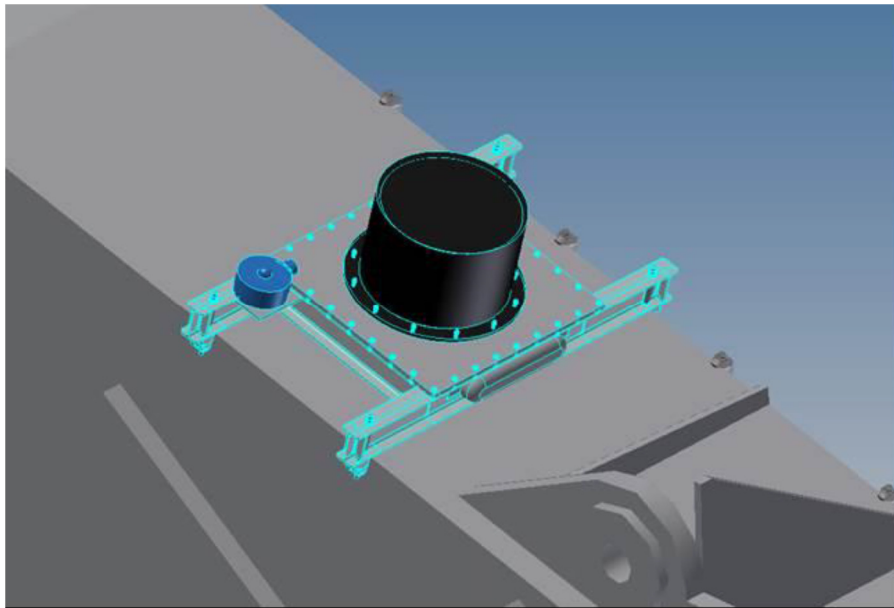
The SGDS report recommended the use of 3 tetrahedral hydrophone clusters, positioned on the legs of the TSS. In combination the 3 clusters will enable detection, identification of species and 3D tracking around rotor swept area and out to several tens of metres of echo locating cetaceans (e.g. harbour porpoise and dolphins). Accuracy should be improved when the PAM units are installed on precise locations on the TSS, whereas in the trial the units were located on separate foundations on the seabed without precise validation of position or angle.

The positions of the PAM units on the TSS are shown in Figure 6.



**Figure 6: Position of Sensors on TSS**

The PAM units will be mounted on the TSS using a clamped system (as shown in Figure 7). The mounting will also house the 2 x video cameras described in Section 5.5.1 below.



**Figure 7: PAM (black) and camera (blue) mounted on TSS leg**

### 5.3 Harbour Seal Telemetry

SMRU aim to deploy ten tags on Harbour seals on the north coast in October 2016 and a further ten tags in March 2017. The tags are UHF / GPS tags, that relay locations in real time to shore stations, and UHF / TDR tags, that relay depth data in real time to shore stations.

It is also proposed to use Vemco pingers on the seals, which can be tracked by the PAM on the TSS. These pingers operate at a frequency of 180 kHz, with 1 ping per second, and a battery life of 131 days. The pingers are due to be tested in early August at SMRU, and if no observable responses are shown, will be deployed on seals together with the other tags.

### 5.4 FLOWBEC Platform (Williamson *et al.* 2015)

The FLOWBEC unit has previously been deployed at the EMEC tidal and wave test sites (Fall of Warness and Billia Croo respectively)<sup>1</sup> and at the MeyGen site in October 2015. In these earlier deployments, the FLOWBEC platform was powered by batteries capable of operating the suite of instruments continuously over a full spring/neap tidal cycle (2 weeks). Under the KTP, FLOWBEC will be connected to the TTG for power and data, allowing the unit to run continuously as necessary. The frame is set-up to be positioned in line with the flood/ebb tide. However, the asymmetrical tide at the TTG locations (270° and 122°) means that the frame target location will be orientated to the wake of the TTG in the flood (east going tide) and will be slightly out of alignment up-stream of the TTG on the ebb (west going tide).

Positions of the FLOWBEC unit and SGDS HiCUP relative to the ARL TTG are shown in Figure 8.

<sup>1</sup> <http://noc.ac.uk/project/flowbec>



Project Environmental Monitoring Programme

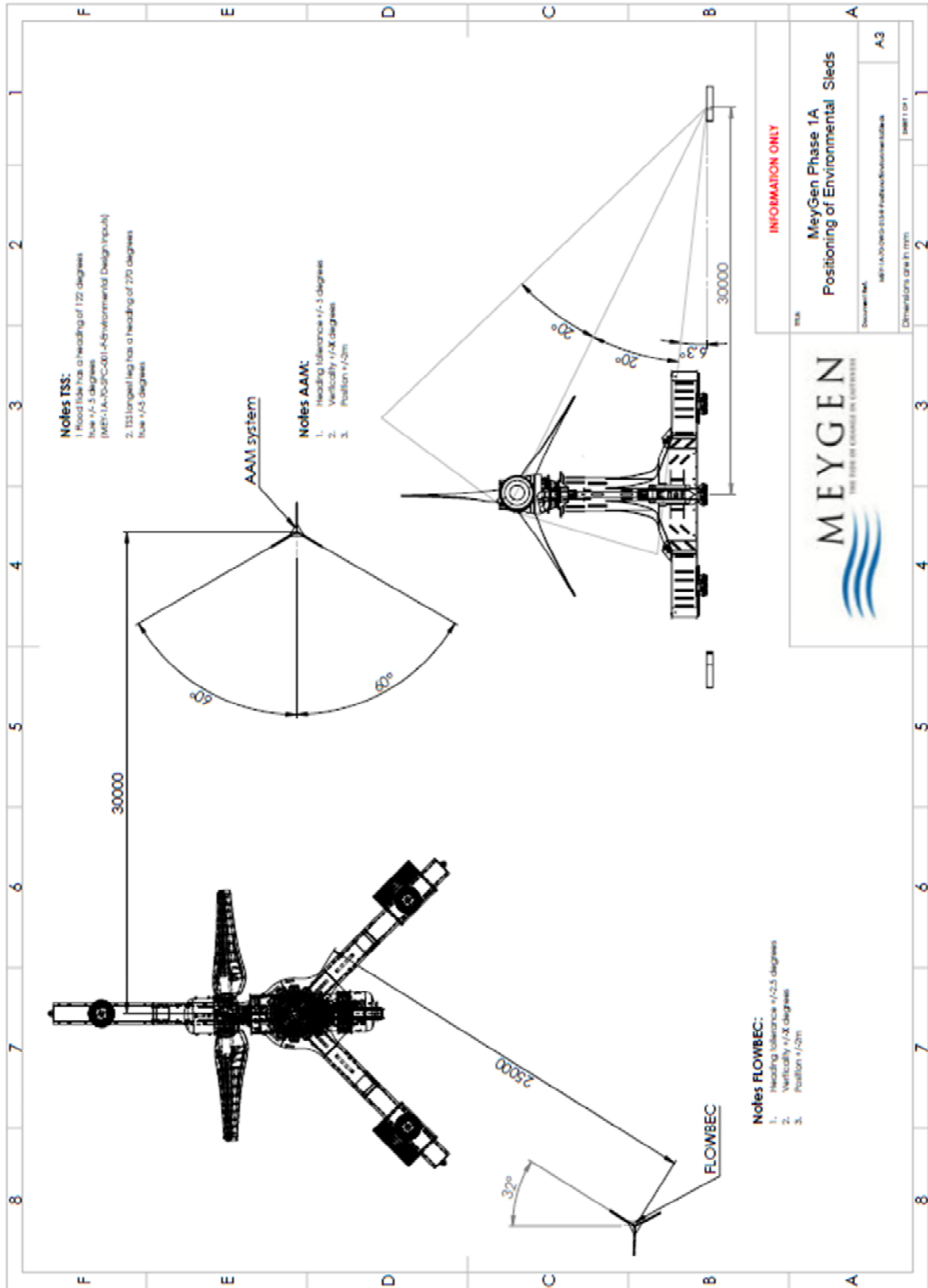


Figure 8: HiCUP and FLOWBEC position relative to ARL TTG

#### **5.4.1 Imagenex multibeam sonar and Multi-frequency Echosounder**

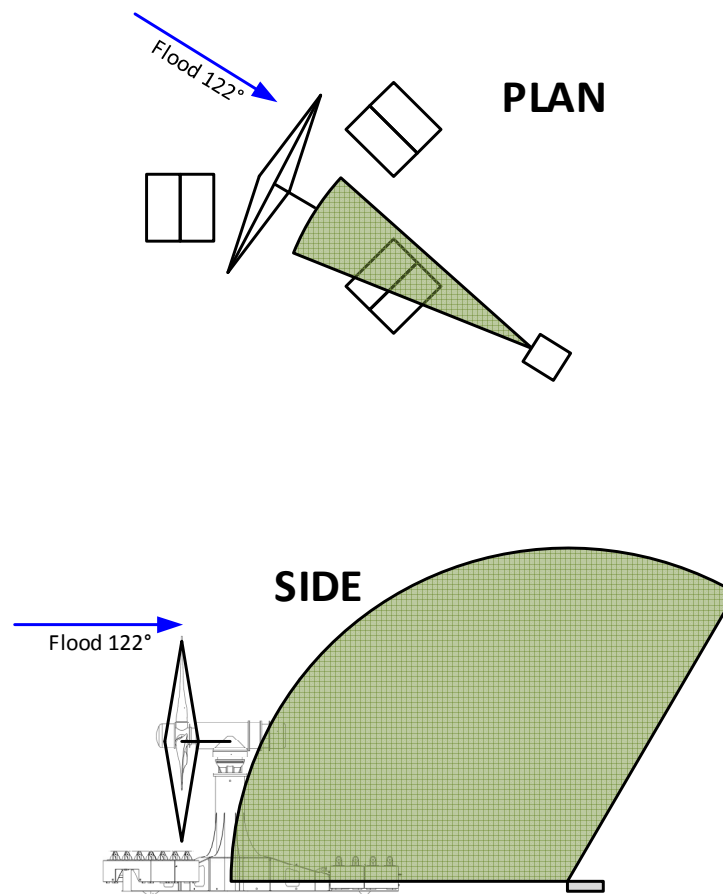
The FLOWBEC unit uses a vertical swath Imagenex 837B Delta T and a vertically-mounted Simrad EK60 multi-frequency echosounder.

The Imagenex active sonar is used for target tracking, classification and observations of behavioural responses of fish, diving seabirds and marine mammals. The vertical swath orientation of the Imagenex gives coverage of the full water column, but with a relatively narrow horizontal band, which will not cover the full swept area of the TTG (as shown in Figure 9).

The vertical swath and position (upstream/downstream of the TTG) means the unit can monitor the full water column, tracking targets above and below the rotor swept area and on their approach/departure from the turbine. The platform is positioned to optimise measurements of targets around the turbine to monitor the ecological relevance of wake/turbulence, potential prey/predator aggregation effects and target behaviour immediately before/after a TTG encounter in the context of the potential for increasing/decreasing collision risk.

The EK60 echosounder operates at 3 frequencies (38, 120 and 200 kHz) and is used for target classification (i.e. debris, fish, diving birds, mammals etc.), species identification for those species with known frequency response, and abundance estimates at all depths throughout the entire water column. At this point, species with known frequency responses include commercial fish and auk (seabird) species. One benefit of concurrent operation of the EK60, multibeam sonars, TTG/TSS cameras, PAM and seal tagging is that it allows classification relationships to be transferred between instruments to some extent, to support later operation with a reduced instrumentation suite, and to provide resiliency in case of instrument failure / degradation. The EK60 information (especially the 200 kHz) is also used to identify ecologically-relevant hydrodynamic and turbulence characteristics to mask from ecological data, and to provide contextual / explanatory information as explanatory variables in the predictive models of collision risk.

Co-registration of targets observed on the two complementary instruments (Imagenex and EK60) provides the most information on target behaviour together with identification, for confirmation on co-registered video data when visibility permits.



**Figure 9: Imagenex orientation**

Algorithms have been developed for target detection and tracking of all targets, including fish, seabirds and marine mammals. Classification of targets can be completed using a combination of methods. The data can be interrogated for thresholds of target morphology (size, shape, target strength etc.) and behaviour (velocity, position in water column, profile etc.). Target classification and detail of individual species identification can also be carried out in combination with the EK60 data using known frequency responses for different fish species, and in combination with video data when visibility permits. The collection of concurrent data across instruments during phase 1 will inform further identification of seabird and mammal species.

Algorithms have also been developed to define a range of turbulence characteristics from EK60 data and to be able to remove turbulence features while leaving the biological data in the water column over all speeds of tide, enabling analysis of animal behaviour and predator-prey interactions at all tidal speeds, all depths and all times of day.

*Project Environmental Monitoring Programme***5.4.2 Fluorometer**

The fluorometer measures turbidity and fluorescence, which can be used as a proxy for phytoplankton. The fluorometer will provide contextual data on biomass/productivity in the water column testing the hypothesis formed at the EMEC tidal energy sites that the advection of productive water masses into the area may signal the arrival/presences of many other species. Measures of turbidity/visibility can be used to predict the perceptual range of animals that may impact and predict the behaviour of species around the TTG.

**5.4.3 ADV**

A SonTek/YSI ADVOcean 5 MHz Acoustic Doppler Velocimeter (ADV) will provide near-bed flow and turbulence data to support the analysis of predator and prey behaviour, and inform collision risk.

**5.4.4 ADCP**

A Nortek Signature 500 kHz 5-beam broadband ADCP mounted on the FLOWBEC platform will provide full-water column measurements of velocity, turbulence and wave height.

**5.5 Video**

The use of video cameras is aimed at detecting collisions with the blades and helping with species identification. However, the video data will be limited to daylight hours in good visibility.

**5.5.1 ARL TTG**

There will be 3 video cameras operating on the ARL TTG.

1) ARL TTG nacelle camera

A single video camera is mounted on the ARL nacelle, behind the rotor. The primary aim of this camera is blade condition monitoring. The camera (Mohn Aqua 400 Series) has a 360° pan/tilt unit, zoom and LED lights. The camera will not be able to cover the full swept area of the TTG rotor nor will it be continually recording data.

Given the limitation of the camera for collision monitoring purposes it is proposed that a sampling schedule is set up for the camera to supplement other datasets.

2) SGDS TSS mounted

Two video cameras will be mounted on the TSS legs (as shown on Figure 6) facing upwards capturing the ebb and flood positions of the TTG. The video cameras (Progressive scan CMOS) have a fisheye lens which will cover 180 degrees by 360 degrees.

The video data will be recorded and sampled based on targets identified on the AAM and PAM systems along with a random sample of data.

*Project Environmental Monitoring Programme***5.5.2 Andritz Hydro Hammerfest (AHH) TTG**

The 3 x AHH TTG will have 3 x video cameras (Seacam Ultra Wide Angle Monochrome UV camera) positioned at 120° around the nacelle to capture 360° view of the turbine rotor. The data will be available through the TTG supervisory control and data acquisition (SCADA) system at the PCUB.

**5.6 Strain Gauges**

All four TTG will have strain gauges fitted to the blades or hub. The strain gauge data will be available through the TTG SCADA system at the PCUB. Samples can be taken for cross referencing against target identification on Active Acoustic Monitoring (AAM), PAM and video.

Further investigation will be required based on operational data to understand the capability of strain gauges to detect collisions.

**5.7 Acoustic Doppler Current Profilers**

Acoustic Doppler Current Profilers (ADCPs) are used to measure flow velocity, turbulence and waves. ADCPs are an integral part of a tidal energy project, especially in the commissioning phase of TTG operation.

ADCPs will be used for:

- 1) TTG performance validation;
- 2) Flow and wave measurements to validate models;
- 3) TTG wake measurements; and
- 4) Contextual data for environmental monitoring.

ADCPs will be positioned on the:

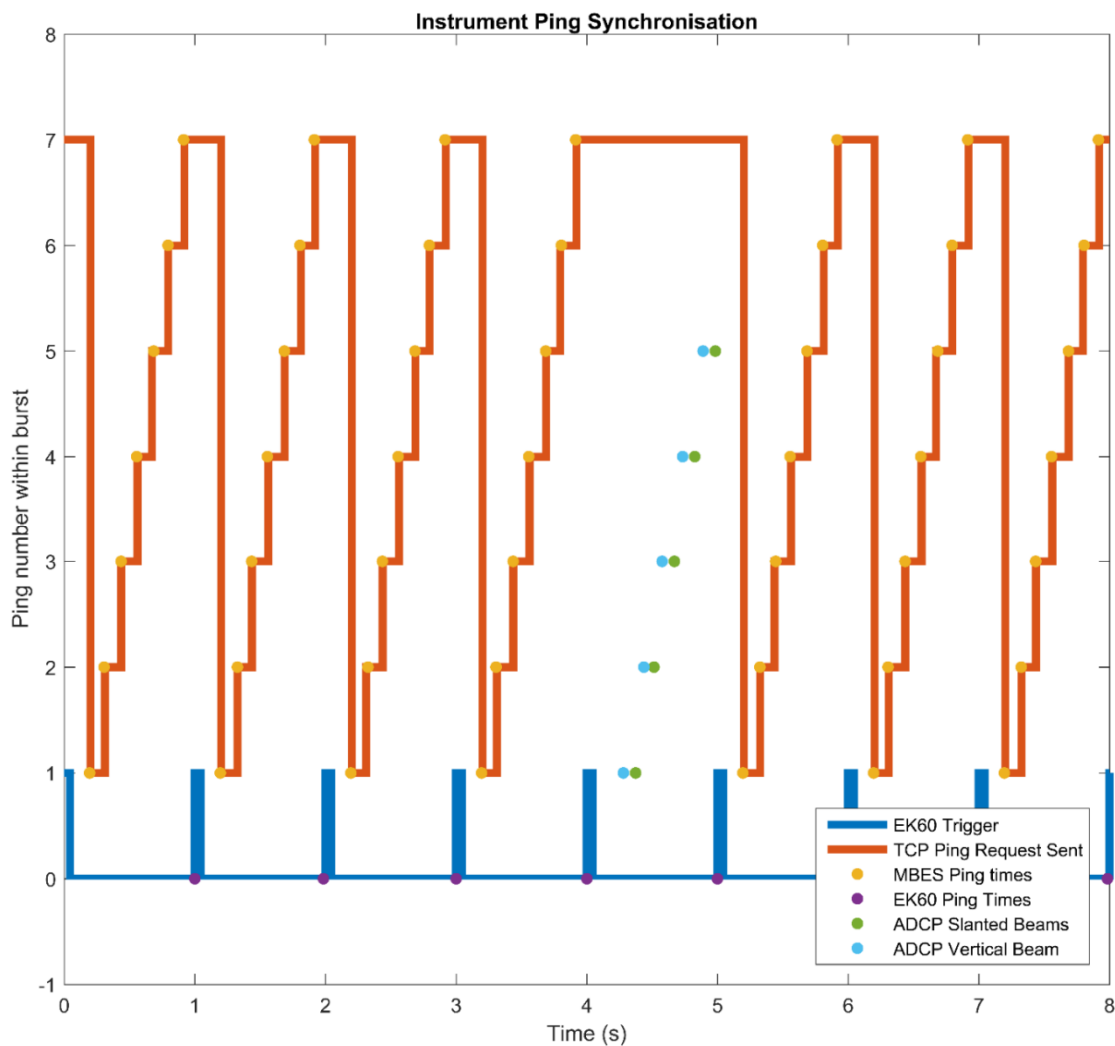
- 1) FLOWBEC platform (1 x vertically mounted Nortek Signature 500);
- 2) ARL TTG nacelle (1 x vertically mounted); and
- 3) AHH TTG (2 TTG with horizontally mounted ADCPs in the nose cone, 1 TTG with 1 x horizontally mounted ADCPs in the nose cone and 1 x vertically mounted on the nacelle).

While ADCPs are important for the performance and monitoring of the tidal turbine array, they present difficulties for the other environmental sensors; this issue is discussed further in Section 5.8 below. The ADCPs listed above are all connected to the TTG system and therefore controllable in some form to ensure cross-talk is minimised. There is the potential that autonomous battery ADCPs could be installed for short periods (typically 28 days), which is most likely to occur at the end of the commissioning period when the TTG performance validation will take place as part of the TTG supply contract. These battery units would not be controlled in the same way as TTG connected ADCPs once they are deployed.

### 5.8 Sensor Cross-talk

The majority of sensors in the monitoring programme and installed around the TTG are acoustic devices. There is potential for sensors installed in close proximity to one another to interfere with each other. The impact of cross-talk between sensors can be mitigated by controlling the timing of active sensor pings or scheduling the sensors so that they do not overlap.

Dr Benjamin Williamson has developed software to control and synchronise multiple instruments that can mitigate cross-talk and enable adaptable sampling and sensor triggering (refer to Figure 10 below). The system was tested on the FLOWBEC platform in field trials at the MeyGen site in October 2015.



**Figure 10: Instrument Ping Synchronisation**

The trial used the Nortek Signature 1000 incorporated into the FLOWBEC system. The trial was a success and this will now transfer to the control of the Nortek Signature 500 that will be on the FLOWBEC platform.

*Project Environmental Monitoring Programme*

There is potential for there to be cross-talk between the monitoring system and the other TTG ADCPs in the array. However, information provided by ADCP manufacturers (and distance between ADCPs on these TTG) suggests this risk is small and, therefore, cross-talk will not be included in the control programme.

### **5.9 Management of EK60**

The 38 kHz frequency of the EK60 is within the hearing range of Harbour seals and therefore there is the potential that the operation of that frequency could cause a change to the natural behaviour of Harbour seals. This is considered an issue, as the behaviour of seals near the turbine blade swept area may therefore include a response not just to the turbine presence, noise and movement, but as this frequency is potentially audible there is concern that it could elicit additional avoidance behaviour and therefore, confound any data on seal avoidance invalidating its use in advancing future collision risk assessments. The 120kHz frequency is within the hearing range of Harbour porpoise, and there is a potential for any side-lobes from the 120kHz to also be within the hearing range of Harbour seals. However, the risk of seals hearing side-lobes from the 120kHz beam is low. The evidence available from the data collected at the MeyGen site in 2015 shows no evidence of low frequency side lobes from the 200 kHz or 120 kHz frequency.

Scottish Association for Marine Sciences (SAMS) are presently undertaking a study that will provide definitive information on the potential audibility of all EK60 signals and side lobes to porpoises and seals. MeyGen anticipate that SAMS will be able to present the findings of their study at the December 2016 Advisory Group.

The ability of the EK60 to identify fish prey species and improve our knowledge of prey behaviour around the TTG is very valuable to understanding collision risk. It will allow investigation of whether the changes in fish behaviour around a tidal turbine structure observed at the EMEC tidal energy site will lead to changes in predator behaviour and lead to different encounter rates than those predicted by the tagging data. The benefit of the EK60 is derived from using 3 different frequencies, whilst this is the case, the University of Aberdeen are satisfied that they can generate data based on 2 frequencies that would allow targets and turbulence to be measured, but it would severely limit the ability to identify to species level and hence decrease predictive power in identifying if harbour seals (or other predators) are present only when specific prey species are present. The EK60 can also operate with just the 200 kHz frequency running and that can provide information on presence/absence of biological targets (but with no ability at all for species ID) but it does provide the data needed to identify the characteristics of turbulence that may be useful in increasing the signal to noise ratio in the strain gauge data.

It is necessary to proceed with caution with the EK60 so as not to risk invalidating other sensor data related to potential collision risk with the TTG. Given that there is this potential risk to compromising the results through avoidance behaviour associated with EK60, the following approach to using the EK60 has been proposed by the SGDS Steering Group and agreed with the MeyGen Advisory Group.

### **5.9.1 Commissioning Phase**

The TTG commissioning phase, which is anticipated to last between 8 to 14 weeks (see Table 3 below) based on the earliest dates depending on sign-off from the MeyGen Project Team, will not include a particular pattern of 'normal' TTG operation. During this commissioning period, it is proposed that the EK60 is run using all 3 frequencies to gather data on prey-predator interactions during a range of TTG on/off times at all ranges of tidal speeds. This approach will be extremely informative in being able to test the effect of blade speed vs tidal speed and predicting which has the greater influence on predator and (species specific) prey behaviour and hence collision risk. All other sensors will also be running during this period, however, the potential effect of the EK60 on animal behaviour rather than direct influence of TTG commissioning will not be known.

### **5.9.2 Start of Normal TTG Operation**

The commissioning phase will be followed by a 14 day 'reliability' test start at full operation of the TTG. At the start of this phase the EK60 will be switched off, during which time data on seal and porpoise collision/close encounter rate and behaviour around the TTG, without the possible confounding behavioural effects of the EK60, will be gathered in order to determine the power of subsequent trials to investigate potential reactions to the EK60.

After eight weeks of full operation of the TTG, there will be a review of the EK60, including a power analysis, and a decision made on how to proceed with the operation of the EK60. There is a risk of biofouling of the transducer if not actively transmitting for long periods of time which will cause degradation / damage to the transducer for future operation.

Further work is planned prior to installation and during commissioning with the EK60 to identify any frequency side lobes that could cause negative behavioural responses. Once data is available it will be reviewed by the Advisory Group to help inform the decision on continued operation with the EK60.



**Table 3 Proposed Timeline for the MeyGen deployment, EK 60 management and reporting schedule.**

[REDACTED]	[REDACTED]	[REDACTED]	[REDACTED]	[REDACTED]
[REDACTED]	[REDACTED]	[REDACTED]	[REDACTED]	[REDACTED]
[REDACTED]	[REDACTED]	[REDACTED]	[REDACTED]	[REDACTED]
[REDACTED]	[REDACTED]	[REDACTED]	[REDACTED]	[REDACTED]
[REDACTED]	[REDACTED]	[REDACTED]	[REDACTED]	[REDACTED]

[REDACTED]

[REDACTED]

[REDACTED]

[REDACTED]

## 5.10 Summary

Table 4 below gives a summary of the sensors that will meet the requirements of the PEMP objectives and S.36 Consent conditions, and provide data to improve the understanding of monitoring systems related to the objectives. Table 5 provides information on the proposed monitoring for each of the point mentioned in condition 12 of the S.36 Consent, and for each receptor identified.

**Table 4: Summary of PEMP sensors**

	Position	Equipment will monitor	Addressing condition 12 of Section 36	Sensors	Interface
<b>SGDS Dual Tritech Gemini</b>	NE side of ARL turbine on HiCUP.	Near field detection, tracking, identification and observations of behavioural responses by marine mammals. Detection of fish and diving birds likely, but species ID unlikely	Provide data used to inform collisions / encounters with turbine, and potentially near field disturbance, thus addressing element b) of condition 12. Focus on marine mammal species. Inferences may be possible in relation to c)	Dual horizontal stacked Tritech Gemini multibeam sonar	Subsea cable linked to TSS junction box
<b>SGDS PAM</b>	3 x hydrophone clusters on TSS, 1 on each leg.	3D tracking and identification of vocalising cetaceans (porpoises and dolphins)		3 x hydrophone clusters; 1 cluster contains 4 hydrophones.	Cabled on TSS to TTS junction box
<b>SGDS Cameras</b>	2 on TSS pointing upstream or downstream	Collision identification of marine mammals, fish and diving birds, and species ID with good visibility		2 x Progressive scan CMOS	Cabled on TSS to TTS junction box
<b>SGDS Seal Tags</b>	2 deployments for 10 tags on harbour seals	Track movement of seals in the area, and in close proximity to ARL turbine using PAM		UHF / GPS tags, UHF / TDR tags, and pingers	
<b>FLOWBEC platform</b>	In front of ARL TTG on ebb tide and in wake on flood tide.	Full water column, near-field tracking, identification and observations of behavioural responses by predators and prey species. EK60 allows classification to species ID level for fish, and to genus level, diving seabirds, with known frequency response. May also be able to ID seals with more data and comparison of positive sightings from other monitoring equipment.	Provide data used to inform collisions / encounters with turbine, and potentially near field disturbance, thus addressing element b) of condition 12. Will also provide data on flow velocity and turbulence, thus partially addressing element a) and, if migratory fish can be detected, address element d). Inferences may be possible in relation to c)	Imagenex multibeam sonar	Subsea cable linked to TSS junction box
				EK60 multi frequency echosounder  SonTek YSI ADV Ocean 5 MHz  Nortek Signature 500 ADCPFluorometer/Turbidity	
<b>MeyGen Cameras</b>	1 x ARL nacelle	Collision identification of marine mammals, fish and diving birds, and species ID with good visibility	Provide data used to inform collisions / encounters with turbine, thus addressing	Mohn Aqua 400 Series	TTG integrated

*Project Environmental Monitoring Programme*

			element b) of condition 12		
<b>AHH Cameras</b>	3 x AHH nacelle 3*120°	Collision identification of marine mammals, fish and diving birds, and species ID with good visibility	Provide data used to inform collisions / encounters with turbine, thus addressing element b) of condition 12	3 x Seacam Ultra Wide Angle Monochrome UV cameras	TTG integrated
<b>MeyGen / AHH Blade monitor</b>	Blade pitch and bearing monitoring system	Possible collision detection for larger bodied animals	Provide data used to inform collisions / encounters with turbine, thus addressing element b) of condition 12.	Strain gauge	TTG internal

**Table 5 Proposed monitoring in relation to condition 12 of the Section 36 consent.**

<b>Section 36 – condition 12</b>	<b>Receptor</b>	<b>Proposed monitoring</b>
<i>a) Hydro dynamics / benthic surveys, export cable route and turbine locations and modelling to validate EIA predictions;</i>		Data from the ADCPs and ADV will provide information on changes in flow around the array, which could be used to validate EIA predictions. Benthic surveys were not considered a high priority by the advisory group (see PEMP Steering Report), and are not currently proposed.
<i>b) Collision / encounter interactions with the tidal turbines for diving birds, marine mammals and fish of conservation concern;</i>	Diving birds	Combined monitoring equipment, including active acoustics and cameras, will enable collision risk monitoring of diving birds.
	Marine mammals	Combined monitoring equipment, including, active acoustics, PAM, seal tagging, cameras and strain gauges, will enable collision risk monitoring of marine mammals.
	Fish	Combined monitoring equipment, including, active acoustics and cameras, will enable collision risk monitoring of fish.

*Project Environmental Monitoring Programme*

<p><i>c) Disturbance and displacement of birds, marine mammals and basking sharks during construction and operation. This must also link to the species protection plan for seals at haul outs; and</i></p>	Birds	<p>Tagging of black guillemot and shag (considered to be the two key species from the Environmental Statement) to investigate disturbance and displacement, was discussed by the advisory group. The Environmental Statement considered that disturbance and / or displacement to seabirds would be unlikely to have a significant impact for the entire (86MW) project. As only 4 turbines will be deployment in the initial deployment, it is even more unlikely that there will be any significant disturbance and / or displacement. Therefore, is aspect of monitoring was not considered a high priority in the PEMP Steering Report.</p>
	Marine mammals	<p>The seal tagging work will provide some information on potential disturbance and displacement of harbour seals. The proposed monitoring equipment, such as active acoustics, PAM, and the cameras, may provide some information on the disturbance and displacement of marine mammals in close proximity to the turbines.</p>
	Basking shark	<p>Very low numbers of basking shark were recorded during the site surveys. It was considered, therefore, that monitoring of this species for disturbance and displacement is a low priority. However combined monitoring equipment, including active acoustics and cameras, will enable collision risk monitoring of Basking sharks.</p>
	Seals	<p>The seal tagging work will provide some information on seal behaviour in the wider area. Seal haulouts in the Pentland Firth and Orkney were surveyed during the August moult by SMRU in 2013, 2015</p>

*Project Environmental Monitoring Programme*

		and 2016. Future monitoring plans of seal haulouts will be confirmed by the Special Committee on Seals (SCOS).
<i>d) Migratory salmonids</i>	Atlantic salmon	The proposed monitoring equipment, such as active acoustics and cameras, may provide some information on the behaviour of Atlantic salmon in close proximity to the tidal array. It is considered, however, that the most appropriate way to improve our knowledge regarding the behaviour of migratory Atlantic salmon in the Pentland Firth and Orkney waters, would be through strategic research, which would benefit not just MeyGen but the marine renewables industry.

## 6 SYSTEM CONNECTION AND INSTALLATION

### 6.1 Connection

The HiCUP, FLOWBEC unit, PAM clusters and TSS cameras are all peripheral to the ARL TTG system. A subsea instrument system has been designed to connect these units to the ARL TTG CaMS. The full system is shown in Figure 12 below.

There is a wet-mate bulkhead connector at the base of the ARL CaMS on the turbine pylon. This connection provides enough power and data to run all the subsea instruments. All the sensors are marshalled to the TSS Junction Box (Figure 11) where a single cable will connect the system into the CaMS using a Remotely Operated Vehicle (ROV) wet-mate receptacle.



**Figure 11: Example of the TSS Junction Box**

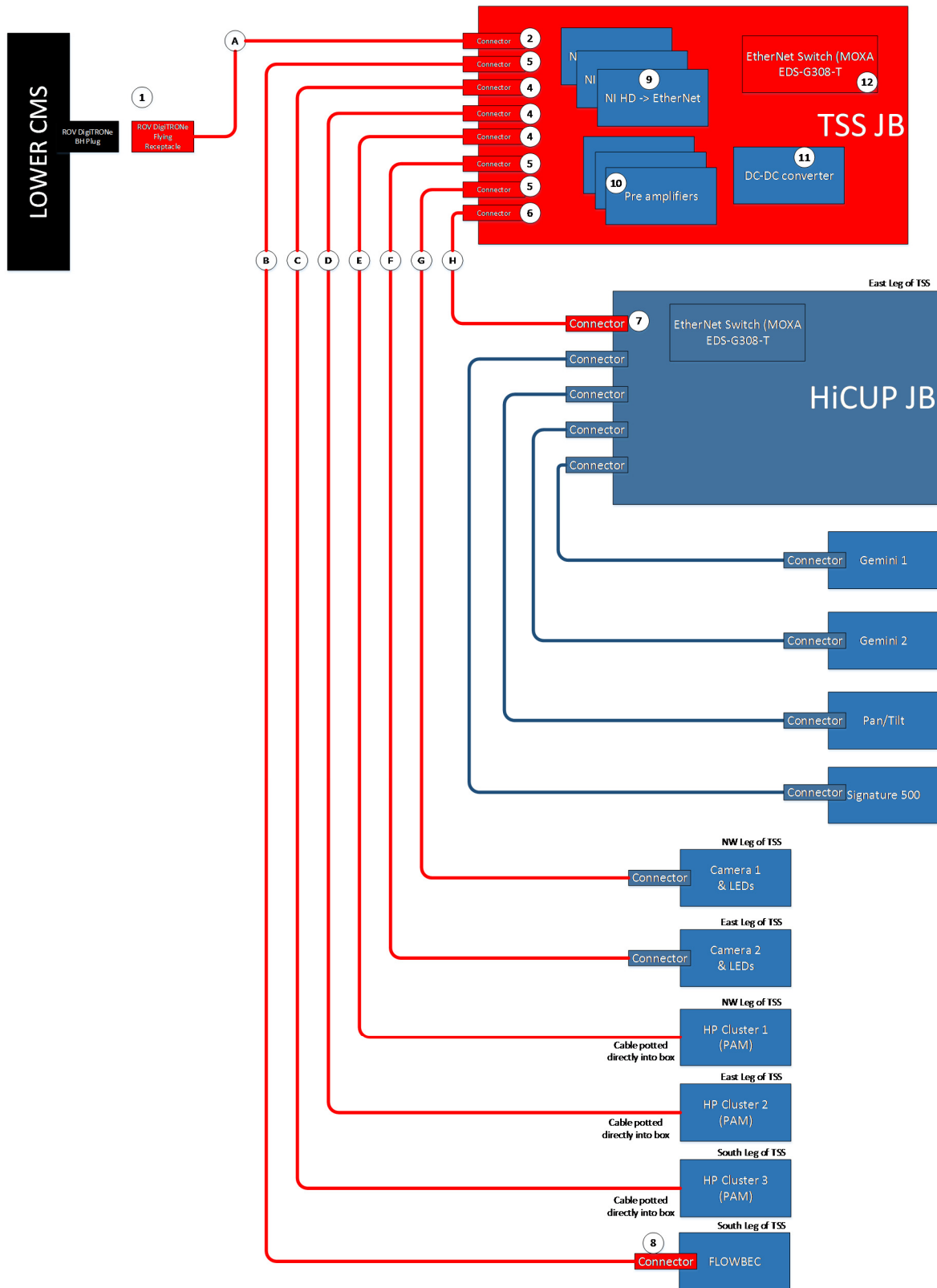


Figure 12: Subsea instrument connection system

## **6.2 Installation**

The TSS Junction Box, PAM clusters, TSS cameras are all installed on the ARL TSS prior to deployment. The PAM and camera cables will be routed back to TSS Junction Box via cable conduit on the TSS.

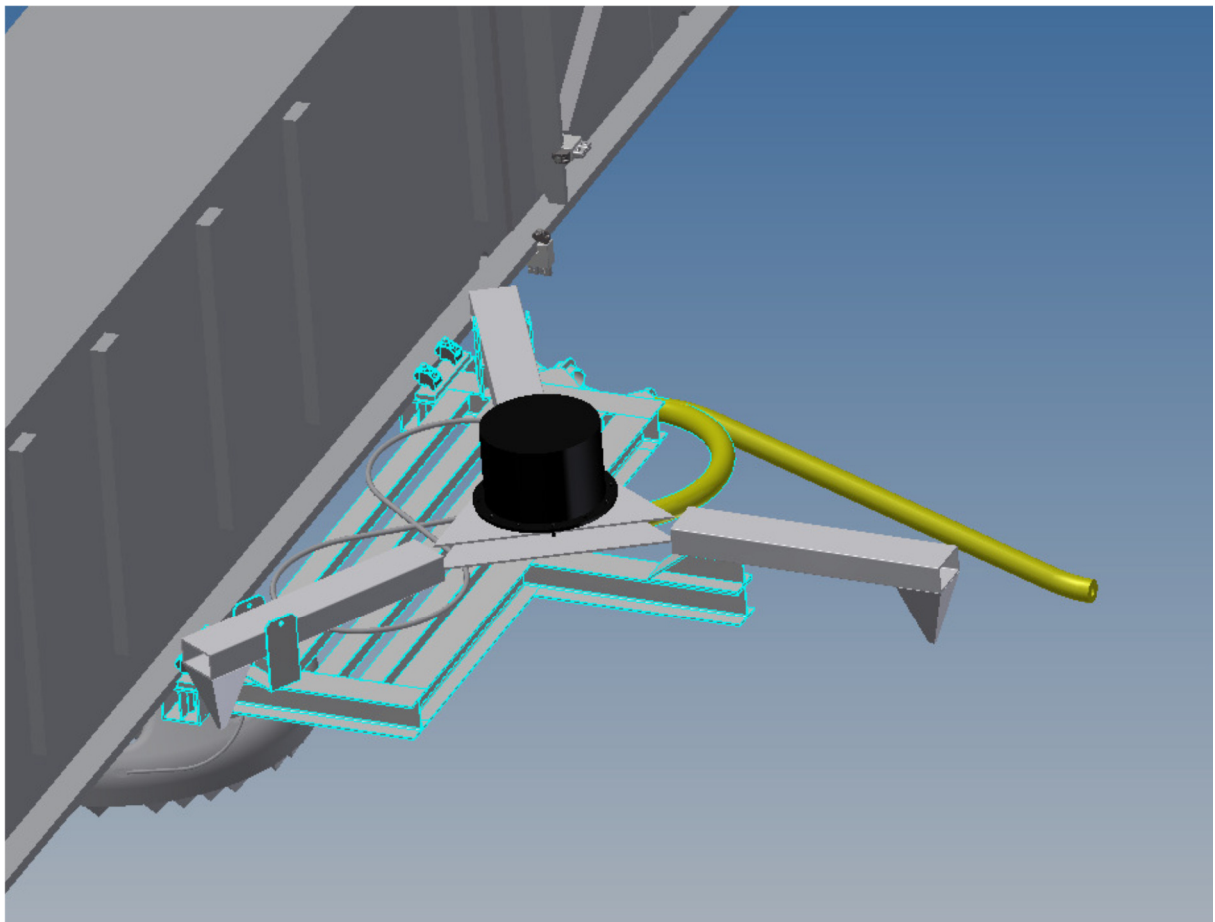
The HiCUP and FLOWBEC unit will be loaded out and transported attached to the TSS. The HiCUP and FLOWBEC connection to the TSS Junction Box will be made prior to loadout. Therefore, this only leaves the wet-mate connection between the TSS Junction Box and TTG CaMS to be made once the TTG is installed. The HiCUP and FLOWBEC units will be carried on the TSS on support platforms installed on the two of the TSS legs (HiCUP platform shown in Figure 13 below). The subsea cables will be positioned on these frames in a figure of eight.

Once the TSS is installed on site, a ROV will attach each frame in turn to the installation vessel crane hook and the vessel will move the unit into location. The cable will spool out from the frame along the seabed. The subsea cables will include suitable bend restrictors and 20mm chain along their length to reduce any risk of bending, movement and abrasion. A decision will be made whether additional stabilisation measures will be required (i.e. rockbags) during post-lay surveys.

A combination of vessel heading, ROV monitoring and bullseye on the two units will position the units accurately within the tolerances required. The ROV will be able to check heading accuracy and pitch/roll. The Tritech Gemini are mounted on a pan/tilt unit, so when the TTG is connected the heading and inclination will be fine-tuned. A final decision on methodology will be made by the installation contractor who will be responsible for installing these units within the tolerances required.

When the TSS and HiCUP/FLOWBEC units have been installed, the TSS ballast blocks and TTG will be installed. An ROV will be required to make the wet-mate connection between the TSS Junction Box and TTG CaMS.





**Figure 13: TSS support frame for the HiCUP**

## **7 CONTINGENCY MEASURES**

### **7.1 System Redundancy**

MeyGen has sought to design a project that requires a minimum number of operations and maintenance interventions for the TTG and associated systems. MeyGen also operate a strict policy on the use of divers and it is extremely unlikely that divers would be permitted for operations on the TTG. Work class ROVs required to complete recovery operations are expensive and require a larger vessel to operate from. The monitoring system has therefore been designed to be as robust as possible with redundancy options which cover failure of equipment that could not be repaired and then redeployed.

The monitoring equipment matrix in Appendix D provides details on each piece of monitoring equipment, what it will monitor, what are the consequences of failure, and what redundancy is available.

The greatest risk with the HiCUP and FLOWBEC units are the subsea cables and connectors, which are less well protected against the site conditions compared to sensors and cables on the TSS. If failures occur, then there are other opportunities to continue monitoring using different methods under the agreement of the AG. If sensors on the HiCUP or part of the connection system fails, the HiCUP frame could be recovered, but the cable would have to be cut and, as recovery and redeployment of the TSS is not possible, then it will not be possible to redeploy the HiCUP. In this scenario, the project has the option to continue to operate with FLOWBEC unit.

The HiCUP and FLOWBEC platform are on different circuits on the TSS. Therefore, if a fault occurs with one of the circuits then it will not affect the other.

If there is a loss of both the HiCUP and the FLOWBEC platform, then the PAM, cameras and strain gauges will still continue to operate and gather data. MeyGen have the option to recover the sensors and move to an autonomous FLOWBEC system run off the batteries. The FLOWBEC unit would then require regular recovery and re-deployment.

Decisions on any contingency measures to be adopted during the monitoring work will be discussed with the Advisory Group. In the event of failure of both Gemini Sonars MeyGen will assess the situation and prepare a briefing document explaining the nature of failure that has occurred, and the options for mitigation. This document will be submitted to MS-LOT who will then consult with the Advisory Group to determine the best solution to be implemented.

The TSS Junction Box, PAM/Cameras and associated cables will be well protected; cables will be routed through conduit fixed to the TSS. The PAM/Camera system and the HiCUP will use either dry-mate connectors or penetrators so a fault in the system will not be able to be fixed as recovery and re-deployment are not possible.

*Project Environmental Monitoring Programme***7.2 Current turbine deployment schedule**

The monitoring system has been designed to be connected to the ARL TTG. The ARL turbine provides enough power and communication bandwidth to run the whole monitoring system.

The current schedule for the installation of the four TSS and TGG is shown in Table 1.

In this current project programme, the ARL TTS with HiCUP and FLOWBEC will be deployed approximately two weeks after the AHH TTG #1. The ARL TTG, with the full suite of monitoring equipment, will be deployed approximately 5 weeks after the AHH TTG #1. In this situation, it is proposed that the PEMP strategy remains the same. The AHH turbine will undergo the commissioning phase over a minimum of 6 weeks, and will be monitored using the 3 x cameras mounted on the TTG nacelle, ADCP and strain gauge data.

If there is a delay to installation of the ARL turbine, greater than approximately 6 weeks (depending on when commissioning finishes) after AHH turbine #1, then MeyGen will investigate deploying the FLOWBEC unit to be installed based on the original battery powered set-up to monitor an AAH turbine.

There is a risk that delays could also be subject to factors outside of MeyGen's control, such as the weather. In these instances, the PEMP will maintain the original plan based on project programme at the start of the turbine installation works (i.e. monitoring equipment connected to the ARL TTG). Decisions on how to proceed will be reviewed regularly in the lead up to installation. The Advisory Group will be consulted on any further changes to the programme.

## 8 SYSTEM TESTING

### 8.1 2015 Field Trials

Field trials were undertaken by SGDS and MeyGen in 2015. The SGDS field trials have informed the decisions on system architecture and can be read in full in the SGDS final report (Sparling *et al.* 2016).

The FLOWBEC field trials successfully:

- 1) Tested sensor synchronisation software;
- 2) Tested deployment methodology and accuracy in the Inner Sound; and
- 3) Gathered baseline data to compare against post-installation data and EMEC data.

The following tests will be carried out during the procurement, manufacture and assembly of the final monitoring system:

### 8.2 Cross-talk Tests

Cross-talk tests were carried out during the FLOWBEC field trials (see section 5.7 Sensor cross-talk). Further tests are required to incorporate the Tritech Gemini in the system and with the synchronisation software.

The process will be required to:

- Develop Gemini interface with Tritech, then bench test;
- Develop Teledyne interface (ARL turbine ADCP), then bench test;
- Confirm synchronisation software developed with Signature 1000 works with Signature 500;
- Assume 5 MHz ADV can be ignored as low power and high frequency;
- Confirm AHH pods and nacelle ADCPs are out of range as minimum separation  $>\sim 100\text{m}$ .
- Verify synchronisation using tank testing.

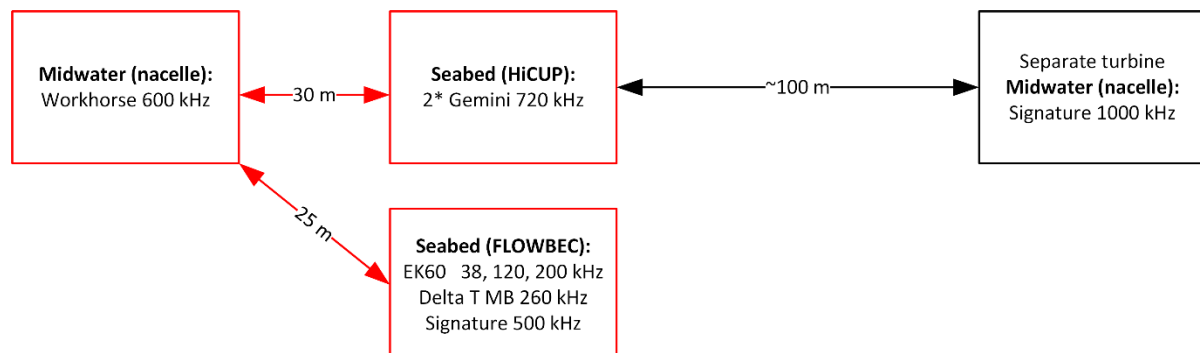


Figure 14 Cross talk tests

### **8.3 Media Converter Tests**

Bench test of bandwidth stability through the media converter (MC) located in the CaMS. This test will be carried out before the MC is sent to ARL and assembled with the CaMS.

- Confirm setup, configuration, operation:
  - Use fibre optic attenuator to represent TSC and interconnect attenuation;
- Verify 2-way communication from copper to fibre (establish communications link, time to establish link from power up);
- Confirm bandwidth matches GigE specification (measured bandwidth of file transfer over a few minutes):
  - Where possible, use instruments to generate representative bandwidth;
  - If instruments not available, use packet capture and generation;
- Confirm latency with and without high bandwidth operation (ping summary report over a few minutes);
- Confirm power consumption under operation (point current measurements over a few minutes);
- Confirm lower voltage operation range (voltage at link dropout, voltage required to re-establish link, time to establish link).

### **8.4 System Testing**

At the assembly facility a full system test can be carried out with all sensors including the TSS Junction Box and shore-side PC hardware.

## 9 DATA MANAGEMENT AND REPORTING

### 9.1 Data Storage

The monitoring equipment will be connected to computers located in the PCUB at the Ness of Quoyoys.

Due to the connection bandwidth available at the Ness of Quoyoys PCUB, large volumes of data created by the monitoring equipment will not be able to be uploaded to other locations. Large data transfers will need to be done in person, swapping over hard-drives at the Ness of Quoyoys on a regular basis. It should be possible to transfer smaller data packages to remote location to provide some processed data and system performance monitoring. Furthermore, remote dial-up works well, where it is possible to take control of the local computer and view the data.

A summary of the data processing and handling requirements for monitoring equipment is discussed briefly below. Further details on the SGDS shoreside set-up can be found in Sparling *et al.* (2016).

#### 9.1.1 PAM

A PC located in the PCUB will run the PAMGuard software. Raw data from the 12 hydrophones will not typically be stored as data rates are too high (TB a day) or would not be transferrable to remote locations. PAMGuard detections and short recordings either side recorded as binary data packages will generally be small enough to be transferrable on an adequate bandwidth. This approach will enable basic data to be reported (number/time of detections) and data quality to be checked. Longer recordings may be required to assist system management.

Larger recordings, triggered by detections and other operational data collected by the software required for off-site maintenance and quality assurance, will be collected from the PCUB on a regular basis.

#### 9.1.2 AAM

A computer located in the PCUB will run the real time data processing, detection and classification software.

Each detection will produce a summary detection file, including timing, location, and velocity. It is anticipated that sonar image data will be continually recording during the initial commissioning phase to determine system capabilities. The AAM should then be able to switch to a more data efficient process using automated detections to select and save a summary detection file and the associated raw data.

Summary files should be small enough to be downloaded to off-site location, which will provide the opportunity for a regular 4 week reporting schedule.

*Project Environmental Monitoring Programme***9.1.3 TSS Video Cameras**

The bandwidth requirements for twin video cameras is  $4 \text{ MB s}^{-1}$  which equates to circa 350 GB per day. An initial commissioning phase will collect continuous data (approximately 1 month) before data recording will be limited to daylight hours. Video files will be available for cross examination against PAM and AMM detections.

**9.1.4 FLOWBEC**

FLOWBEC raw data volumes are feasible for continuous acquisition and storage on site, totalling approximately 2 TB per year. Post-processing, decompression and back up will be performed off-site onto a larger disk array. A remote connection will be used for configuration, duty cycling and status checking. Manual exchange of disks or download of data can be used if the remote connection bandwidth is insufficient for remote data download.

**Error! Reference source not found.**below lists summary data outputs. The raw datasets can be used for detection, triggering, classification and training datasets for algorithm development. The results of more detailed analyses will also be useful for site comparisons, development of predictive tools, and training datasets.

<b>Instrument</b>	<b>Raw volume (GB/Year):</b>	<b>Summary output:</b>
EK60	150	Target distributions and classification Turbulence bulk statistics and morphology
Multibeam	1700	Target distributions and classification Track events and summary statistics
ADV	70	Near-bed velocity and turbulence characteristics
Fluorometer	1	Fluorescence and turbidity
ADCP	3	Contextual velocity for target tracking

**Table 6 Summary data outputs**

**9.2 Reporting**

The Head of Environment and Consents will collate reports on a 4 week cycle (see Table 3) from the SGDS, University of Aberdeen, and MeyGen and report these to the Advisory Group based on the S.36 Consent conditions. Template reports are currently being produced, and example templates will be added to the PEMP once finalised.

There will be a review period after the first 8 weeks of full turbine operation.

The reports will provide the data and results from the monitoring. This will then be used by the Advisory Group to address the PEMP objectives, which are:

- To detect and quantify potential avoidance and collision rates for Harbour seals, and verify and improve the accuracy of collision/encounter rate models; and
- To provide sufficient monitoring data for impact assessment to allow each subsequent stage of the Development to proceed.

*Project Environmental Monitoring Programme*

Empirically measured close range encounter or passage rates may be substituted for the density inputs into collision risk models, and any measured avoidance or evasion may be translated into avoidance rates. The combination of these two factors will allow a more realistic calculation of collision risk for subsequent stages.



*Project Environmental Monitoring Programme***10 LICENCES AND LEGAL REQUIREMENTS**

The licence and legal documentation associated with the Development and pertinent to the PEMP is shown below:

<b>Licence / Consent</b>	<b>Legislation</b>	<b>Granted</b>
Section 36 Consent	Electricity Act 1989	09/10/2013
Marine Licence (04577/14/0)	Marine (Scotland) Act 2010	31/01/2014
Marine Licence (05647/15/0)	Marine (Scotland) Act 2010	04/09/2015
Marine Licence (06045/16/0)	Marine (Scotland) Act 2010	19/07/2016
Marine Licence (04577/16/0)	Marine (Scotland) Act 2010	29/07/2016
Decommissioning Programme	Energy Act 2005	Submitted

**Table 7 Licences**

*Project Environmental Monitoring Programme***11 LINKAGES WITH OTHER CONDITIONS**

The PEMP is part of suite of consent related documents. Table 8 lists the documents and related conditions that are relevant to the PEMP.

**Table 8 Linkages with other conditions**

Condition	Condition summary/Reason/stage development	Linkage and Document
S36 9	CMS details mitigation measures to prevent adverse impacts to species and habitats during construction Reason - To ensure the appropriate construction management of the Development, taking into account mitigation measures to protect the environment and other users of the marine area.	CMS must, so far as is reasonably practicable, be consistent with the PEMP, EMP VMP & NSP.
S36 10	ECoW appointment from commencement of the Development until the Final Commissioning of Stage One of the Development	Ensuring all works are carried out in accordance with the CMS, EMP, PEMP, VMP & NSP. ECoW will cover reporting on installation of monitoring equipment in line with CMS, EMP, VMP, NSP. Reporting on PEMP data, results and objectives will be the responsibility of the Head of Environment and Consents.
S36 11	EMP covers monitoring through ALL stages of the Development Reason - In the interests of protecting the environment.	Environmental Management Plan (EMP) must, so far as is reasonably practicable, be consistent with any relevant monitoring requirements during construction taken from the PEMP. The EMP details measures through all stages of the Development, to prevent adverse impacts including, but not limited to, marine mammals, birds, fish and habitats as outlined in Chapter 25 of the Company's Environmental Statement.
S36 13	Reason: to ensure effective research and monitoring is undertaken and to review the objectives, outputs and timescales of the monitoring programme The AG will be in place throughout ALL phases of the Development	Establish an Advisory Group, which oversees the PEMP under the Advisory Group Terms of Reference.
S36 14	Reason: to minimise the disturbance to seal haul outs, marine mammals and basking sharks as well as consideration of mitigation measures for cork screw injuries to seals VMP applies to the construction and operation of the Development	Vessel Management Plan (VMP) must, so far as is reasonably practicable, be consistent the PEMP, EMP, CMS & NSP.
S36 15	Reason: to mitigate the impacts of operations and maintenance and to fully inform any mitigation and monitoring requirements for natural heritage interests. OMP applies to operation phase of the Development	Operations and Maintenance Programme (OMP).
S36 16	Reporting Protocol for the Discovery of Marine Archaeology. Applies to ALL phases of the Development	Within the Environmental Management Plan (EMP)
S36 17	Reason: in the interest of safe navigation	Navigation Safety Plan (NSP)
ML 3.1.3	Notification of Vessels	Requirement covered in Construction Method Statement (CMS) Vessel Management Plan (VMP)
ML 3.2.1.1	EMF Best Practice Report	Requirement covered in EMF Best Practice Report
ML 3.2.1.3	Marine Pollution Contingency Plan	Requirement covered in Environmental Management Plan
ML 3.2.1.4	Notification of Commencement	Requirement covered in Construction Method Statement
ML 3.2.1.5	ECoW applies to installation and commissioning	Ensuring all works are carried out in accordance with the CMS, EMP, PEMP, VMP & NSP. ECoW will cover reporting on installation of monitoring equipment in line with CMS, EMP, VMP, NSP. Reporting on PEMP data, results and objectives will be the responsibility of the Head of Environment and Consents.
ML 3.2.1.6	Promulgation of navigation warnings	Requirement covered in Navigation Safety Plan
ML 3.2.1.7	Marine Mammal Observer	Requirement covered in Environmental Management Plan
ML 3.2.1.8	Cable Installation Plan	Requirement covered in Construction Method Statement
ML 3.2.1.9	Cable Protection Plan	Requirement covered in Construction Method Statement
ML 3.2.2.1	Transport Audit Sheets	Requirement covered in Construction Method Statement
ML 3.2.2.2	Notification of Deposits	Requirement covered in Construction Method Statement

*Project Environmental Monitoring Programme*

Table 9 below shows how the PEMP sits with the other project plans during the different stages of the project.

**Table 9 Project plans during each stage of the development process**

Stage of development	EMP	PEMP	OMP	CMS	VMP	NSP	EMF	DP
Pre-construction	Yes	Yes	No	No	Yes	Yes	No	No
Construction	Yes	Yes	No	Yes	Yes	Yes	Yes	No
Operation & Maintenance	Yes	Yes	Yes	No	Yes	Yes	Yes	No
Decommissioning	Yes	Yes	Yes	No	Yes	Yes	Yes	Yes

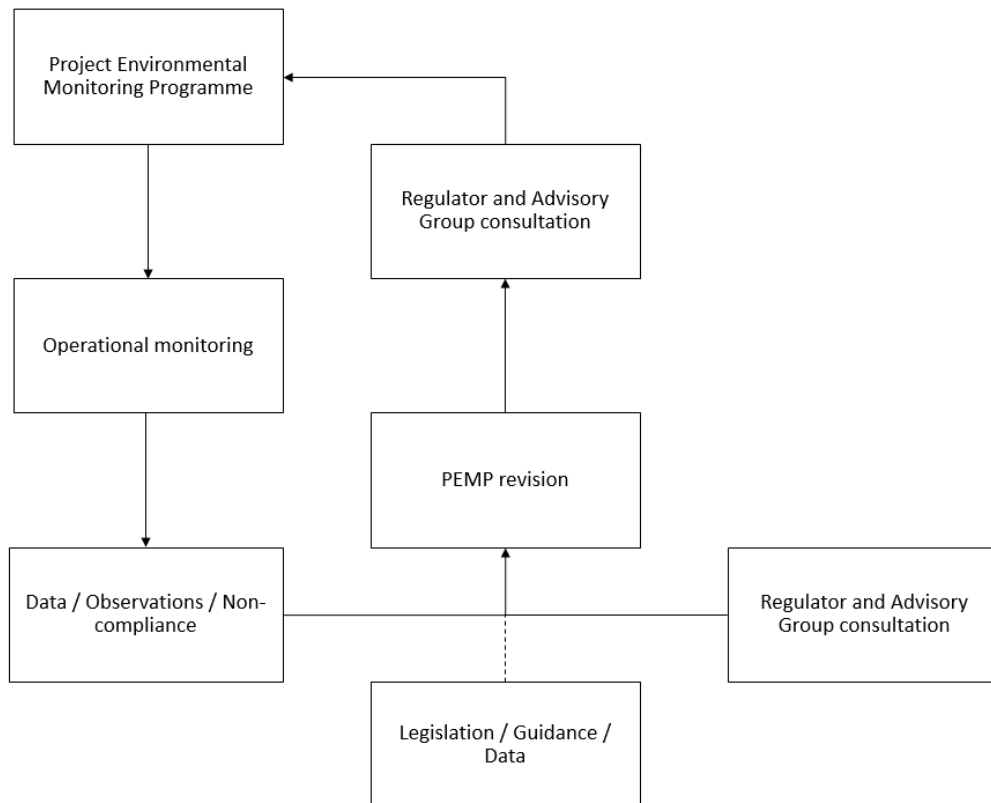
**12 PEMP REVIEW AND CONSULTATION**

Under Condition 12 of the S.36 Consent the PEMP will be submitted for approval by Scottish Ministers, in consultation with SNH and any other ecological, or such advisors as the Scottish Ministers require.

Any changes the PEMP deemed necessary (working methods or procedures) must be submitted for approval to the Scottish Ministers (see Figure 14) and reviewed by the Scottish Ministers, SNH and the Advisory Group. Any amendments to the PEMP must be approved by the Scottish Ministers.

The PEMP must be regularly reviewed by the Scottish Ministers, at timescales to be determined by the Scottish Ministers, in consultation with SNH and the Advisory Group. Following such review, the Scottish Ministers may, in consultation with SNH and the Advisory Group, require the PEMP to be amended for the approval of Scottish Ministers, in consultation with SNH and any other ecological, or such other advisors as required at the discretion of the Scottish Ministers. The PEMP will be submitted to the Scottish Ministers for distribution to the Advisory Group.

Version control will be conducted by the revision review block on the front page of the PEMP.



**Figure 15 PEMP Change Process**

*Project Environmental Monitoring Programme***13 LIST OF ABBREVIATIONS**

<b>Abbreviation</b>	
ARL	Atlantis Resources Limited
AHH	Andritz Hammerfest Hydro
CMS	Construction Method Statement
CaMS	Cable Management System
DP	Decommissioning Programme
ECoW	Ecological Clerk of Works
EIA	Environmental Impact Assessment
EMP	Environmental Management Plan
ES	Environmental Statement
NSP	Navigation Safety Plan
OMP	Operations and Maintenance Programme
ML	Marine Licence under the Marine (Scotland) Act 2010
PCUB	Power Conversion Unit Building
PEMP	Project Environmental Monitoring Programme
SEIS	Supplementary Environmental Information Statement
SNH	Scottish Natural Heritage
S.36	Section 36 of the Electricity Act 1989
TSC	Turbine Submarine Cable
TSS	Turbine Support Structure
TTG	Tidal Turbine Generator
VMP	Vessel Management Plan

**14 REFERENCES**

Hastie G.D. (2012). Tracking marine mammals around marine renewable energy devices using active sonar. SMRU Ltd report number SMRUL-DEC-2012-002 to the Department of Energy and Climate Change, pp. 93. SMRU Ltd, St Andrews.

Sparling C., Gillespie D., Hastie G.D., Gordon J., Macaulay J., Malinka C., Wu M. and McConnell B. (2016). Scottish Government Demonstration Strategy: Trialling methods for tracking the fine scale underwater movements of marine mammals in areas of marine renewable energy development. Scottish Marine and Freshwater Science Vol 7 No 13.

Williamson B.J., Blondel Ph., Armstrong E., Bell P.S., Hall C., Waggitt J.J., Scott B.E. (2015). A Self-Contained Subsea Platform for Acoustic Monitoring of the Environment Around Marine Renewable Energy Devices – Field Deployments at Wave and Tidal Energy Sites in Orkney, Scotland. IEEE Journal of Oceanic Engineering. <http://dx.doi.org/10.1109/JOE.2015.2410851>

**APPENDIX A: CONDITION 12 OF SECTION 36 CONSENT**

*The Company must, no later than 3 months prior to the Commencement of the Development, submit a Project Environmental Monitoring Programme (“PEMP”), in writing, for the approval of the Scottish Ministers, in consultation with SNH and any other ecological, or such other advisors as required at the discretion of the Scottish Ministers. The PEMP must set out the measures of monitoring the environmental impacts of all stages of the Development, including the pre-construction, construction, and operational stages.*

*The PEMP must be regularly reviewed by the Scottish Ministers, at timescales to be determined by the Scottish Ministers, in consultation with SNH and the Advisory Group referred to in condition 13 of this consent. Following such review the Scottish Ministers may, in consultation with SNH and the Advisory Group, require the Company to amend the PEMP and submit such an amended Programme to them, in writing, for their approval, in consultation with SNH and any other ecological, or such other advisors as required at the discretion of the Scottish Ministers.*

*The monitoring set out in the PEMP or, as the case may be, an amended PEMP, (which must be agreed by the Scottish Ministers, in consultation with SNH and any other ecological, or such other advisors as required at the discretion of the Scottish Ministers), must be implemented by the Company. The Company must submit written reports of such monitoring to the Scottish Ministers at timescales to be determined by the Advisory Group. In particular, the following aspects should be considered and advice provided regarding the monitoring of the following aspects:*

- a) Hydro dynamics / benthic surveys, export cable route and turbine locations and modelling to validate EIA predictions;*
- b) Collision / encounter interactions with the tidal turbines for diving birds, marine mammals and fish of conservation concern;*
- c) Disturbance and displacement of birds, marine mammals and basking sharks during construction and operation. This must also link to the species protection plan for seals at haul outs; and*
- d) Migratory salmonids*

*Subject to any legal restrictions regarding the treatment of the information, the results must be made publicly available by the Scottish Ministers, or by such other party appointed at their discretion.*

**APPENDIX B: MONITORING PROGRAMME STEERING REPORT**





**Project Environmental  
Monitoring Programme  
– Steering Report**



<b>Author:</b> Ed Rollings	<b>Document No:</b> 01	<b>Revision:</b> 4	<b>Date:</b> 23/05/2014
<b>Document Type:</b> Method Statement			
<b>Document Title:</b> Project Environmental Monitoring Programme – Steering Report			



### Document History and Status

Revision	Approved by (internally)	Date approved	Date issued	Comment
1			21/02/2014	
2			26/03/2014	Edits including addition of objective priorities and AG recommendations
3			22/04/2014	Revise to more appropriately include the consent conditions
4			23/05/2014	Incorporation of final AG comments

### Distribution of Copies

Revision	Media	Issued to	Company
1	.docx	MeyGen AG	
2	.docx	MeyGen AG	
3	.docx	MeyGen AG	
4	.docx	MeyGen AG	

**London Office**  
 King's Scholars House, 230 Vauxhall Bridge Road, London, SW1V 1AU  
 Tel +44 207 901 1521  
[www.meygen.com](http://www.meygen.com)

## Contents

<b>1.</b>	<b>INTRODUCTION.....</b>	<b>1</b>
1.1	<b>MeyGen Limited. ....</b>	<b>1</b>
1.2	<b>Consented Project .....</b>	<b>1</b>
1.3	<b>Description of the Phase 1a Project.....</b>	<b>1</b>
1.3.1	Tidal Turbine Generators .....	1
1.3.2	Turbine Support Structure.....	1
1.3.3	Turbine Submarine Cable .....	1
1.3.4	Onshore Infrastructure .....	2
1.3.5	Programme .....	2
1.4	<b>MeyGen Advisory Group.....</b>	<b>2</b>
1.4.1	MeyGen AG Workshop 28 <sup>th</sup> January 2014 .....	2
1.5	<b>Purpose of the Document .....</b>	<b>2</b>
<b>2.</b>	<b>STRATEGIC OBJECTIVES .....</b>	<b>3</b>
2.1	<b>Strategic PEMP Objectives .....</b>	<b>3</b>
2.2	<b>SNH Recommendations .....</b>	<b>3</b>
2.2.1	Marine mammals .....	4
2.2.2	Fish of conservation concern .....	5
2.2.3	Seabirds.....	5
2.2.4	Physical processes .....	5
2.2.5	Benthic habitats and species .....	5
2.2.6	Noise monitoring .....	5
<b>3.</b>	<b>STRATEGIC, PLANNED AND ON-GOING RESEARCH.....</b>	<b>6</b>
3.1	<b>Marine Scotland Scientific Research.....</b>	<b>6</b>
3.2	<b>Marine Scotland Demonstration Strategy: Trialling methods for tracking the fine scale underwater movements of marine mammals in areas of marine renewable energy development.....</b>	<b>6</b>
3.3	<b>Marine Scotland research on Atlantic salmon, Sea trout and European eel.....</b>	<b>7</b>
3.4	<b>Marine Scotland Atlantic salmon tagging study.....</b>	<b>8</b>
3.5	<b>SMRU Seal Tagging in the Inner Sound .....</b>	<b>9</b>

3.6	SMRU - Active Sonar at Siemens/MCT Strangford Loch .....	9
3.7	FLOWBEC – NERC funded Consortium led by NOC .....	10
3.8	EMEC Integrated Monitoring Pod.....	11
3.9	Black Guillemot and Shag tagging – Dr Elizabeth Masden, Environmental Research Institute .....	11
3.10	Pentland Firth Initiative – University of Highland and Islands (Professor Stuart Gibb) 12	
3.11	Particle tracking to simulate Atlantic salmon movement in the Pentland Firth – Dr Andrew Guerin, Environmental Research Institute.....	12
3.12	Seal haul-out counts - SCOS .....	13
3.13	Strandings Data.....	14
3.14	Strangford Lough Benthic Habitats Survey .....	15
3.15	RESPONSE – NERC funded study led by SMRU at the University of St Andrews (Dr David Thompson).....	15
3.16	EMEC Harbour seal haul-out monitoring 2010 .....	16
4.	MONITORING TECHNOLOGY AND TECHNIQUES.....	17
4.1	Active Sonar .....	17
4.2	Passive Acoustics and Pinger Tags .....	17
4.3	Positioning and Depth-Time Recorder Tags .....	18
4.4	Video and Still Cameras .....	18
4.5	Blade-mounted Technology.....	19
4.6	Current Profilers.....	19
4.7	Hydrophone - turbine noise .....	19
4.8	Population monitoring.....	20
4.9	Strandings Scheme .....	20
5.	PEMP OBJECTIVES .....	21
5.1	Draft PEMP Objectives .....	21
5.1.1	Harbour seal.....	21
5.1.2	Grey seal.....	22
5.1.3	Cetaceans .....	23
5.1.4	Migratory salmonids.....	23
5.1.5	Diving birds .....	24

5.1.6	Physical processes .....	24
5.1.7	Benthic Habitats .....	25
5.1.8	Turbine noise .....	25
<b>6.</b>	<b>ADVISORY GROUP RECOMMENDATION FOR MONITORING.....</b>	<b>26</b>
<b>6.1</b>	<b>Active Sonar and complementary technology.....</b>	<b>26</b>
6.1.1	Video .....	26
6.1.2	Strain Gauge .....	26
6.1.3	Hydrophones.....	26
6.1.4	Current profilers .....	26
6.1.5	Development requirements.....	26
<b>6.2</b>	<b>Passive acoustics and Pinger tags .....</b>	<b>27</b>
6.2.1	Complementary technology .....	27
6.2.2	Development requirements.....	27
<b>6.3</b>	<b>System platform .....</b>	<b>27</b>
<b>6.4</b>	<b>Stranding Scheme.....</b>	<b>28</b>
<b>6.5</b>	<b>Harbour Seal Haul-out Site Monitoring.....</b>	<b>28</b>
<b>6.6</b>	<b>Physical Processes Monitoring.....</b>	<b>28</b>
<b>6.7</b>	<b>Noise Modelling.....</b>	<b>28</b>
<b>7.</b>	<b>ACTIONS .....</b>	<b>29</b>

## 1. INTRODUCTION

### 1.1 MeyGen Limited.

MeyGen Ltd (“MeyGen”) is a Scottish registered company created in 2010 for the purpose of developing the MeyGen project. MeyGen is a wholly owned subsidiary of the Atlantis Group.

MeyGen has an in-house development team with a broad range of expertise and experience in offshore energy project development and managing the successful installation of tidal energy devices.

### 1.2 Consented Project

MeyGen was awarded an Agreement for Lease for the Inner Sound tidal development site by The Crown Estate (TCE) in 2010. The Inner Sound Agreement for Lease is for the installation of 398MW tidal stream energy capacity by 2020. The Inner Sound is the body of water in the Pentland Firth between the north coast of the Scottish mainland and the island of Stroma.

Phase 1 of the project, which will have a maximum aggregated capacity of 86MW, with up to 61 tidal turbines, was granted consent by the Scottish Government (Application ref 130901 - 009/TIDE/MGIS1 - 6). The associated onshore infrastructure at the Ness of Quoy was granted consent by The Highland Council (Application reference 12/02874/FUL<sup>1</sup>).

To summarise, the project included:

- Up to 61 tidal turbine generators (TTG) (maximum generating capacity of 86MW) with associated turbine support structure (TSS);
- Individual Turbine Submarine Cables (TSCs) to shore via HDD bores; and
- An onshore Power Conversion Centre (PCC).

### 1.3 Description of the Phase 1a Project

The following section describes Phase 1a infrastructure.

#### 1.3.1 Tidal Turbine Generators

Phase 1a will consist of 4 Tidal Turbine Generators (TTG)<sup>2</sup>, including 3 Andritz Hammerfest Hydro and 1 Atlantis Resources Ltd. The turbines are 1.5MW rated capacity with a rotor diameter of 18m. The TTG will be installed on the Turbine Support Structures (TSS) from a DP vessel using a heavy lift crane.

#### 1.3.2 Turbine Support Structure

The TTG will be supported on Gravity-base TSS. The Gravity-base TSS require no drilling operations to secure them to the seabed. The TSS will be installed from a DP vessel using a heavy lift crane.

#### 1.3.3 Turbine Submarine Cable

Each TTG will have a dedicated Turbine Subsea Cable (TSC) to shore. The TSC will be brought onshore via individual Horizontal Directional Drilled (HDD) bores. The HDD bore exits on the seabed will be approximately 700m from shore. The TSC will be pulled through bore to onshore before being laid on the seabed to the TTG using a cable installation vessel. Given the scoured bedrock seabed, the TSC will not be buried.

---

<sup>1</sup> MeyGen were also granted consent for the Ness of Huna (Application reference 12/02875/FUL) however, MeyGen plan to take the Ness of Quoy site forward for Phase 1.

<sup>2</sup> The MeyGen Project Phase 1 is limited to up to 6 turbines in Phase 1a, under the Section 36 consent conditions.

### 1.3.4 Onshore Infrastructure

Phase 1a will require an onshore converter, transformer and switchgear to be housed in Power Conversion Unit Building (PCUB) at the Ness of Quoys. The TSC will be terminated in the PCUB before the electricity generated will be exported to the local distribution network via a 33kV underground cable.

### 1.3.5 Programme

The high level construction programme for Phase 1a is as follows:

- Onshore civil infrastructure and HDD Q4 2014 - Q1 2015
- TSS installation Q2 2015
- TSC installation Q3 2015
- TTG installation Q4 2015 - Q1 2016

## 1.4 MeyGen Advisory Group

The MeyGen Advisory Group (AG) was set up on 27<sup>th</sup> November 2013 in accordance with Condition 13 of the Section 36 consent conditions.

The AG is designed, amongst other duties, to oversee the development and implementation of the Project Environmental Monitoring Programme (PEMP). The membership includes representation from MeyGen Ltd., Marine Scotland Licensing Operations Team (MSLOT), Marine Scotland Science (MSS), Marine Scotland Planning and Policy (MSPP), Scottish Natural Heritage (SNH) and The Crown Estate (TCE). Full details are available in the Terms of Reference.

### 1.4.1 MeyGen AG Workshop 28<sup>th</sup> January 2014

A workshop was held at SNH office in Battleby on 28<sup>th</sup> January 2014 to bring together regulators, stakeholder and academics to discuss monitoring requirements for Phase 1a of the project. The aim was to gather as much information on current and planned research in the areas identified for the MeyGen PEMP and facilitate the discussion to evaluate potential integrated monitoring solutions for multiple receptors. The results of the workshop are collated in a workshop document and summarised and reviewed in section 4 of this document.

## 1.5 Purpose of the Document

The Steering Report is designed to refine the consent conditions to objectives and concepts for the development of the PEMP. The report takes the lessons learnt from previous research and identifies where current and planned research will contribute to meeting the needs of the consent conditions and wider industry questions. Bringing these together, the report recommends more specific objectives, which can be taken forward and developed for the PEMP and are appropriate for addressing the consent conditions.



## 2. STRATEGIC OBJECTIVES

The following section outlines the strategic objectives for the MeyGen PEMP and for each sensitive receptor. These are based on:

1. The project Environmental Statement, Habitats Regulations Appraisal and Supplementary Environmental Information Statement;
2. Section 36 consent conditions under the Electricity Act 1989;
3. Marine Licence conditions under Marine (Scotland) Act 2010;

Section 3 reviews research that will meet some of the strategic objectives; section 4 summarises the known monitoring technology and techniques and their development requirements. These two sections provide evidence to refine the strategic objectives to operational objectives (section 5) and a broad monitoring proposal outlined in section 6 for the PEMP.

### 2.1 Strategic PEMP Objectives

There are a number of conditions that relate to the PEMP; however there are two directly relevant conditions. Condition 2 of the Section 36 consent, which restricts the Project to up to 6 turbines, is designed to prevent significant adverse impacts to the environment (in particular harbour seal and Atlantic salmon). The restriction to 6 turbines is based on the risk of significant adverse impacts on the current harbour seal population within the Orkney and North Coast Management Unit.

Whilst Condition 2 is in place and to provide information to allow the Project to move past this restriction, the MeyGen PEMP broad objectives are to:

1. Generate sufficient understanding of the environmental interactions and uncertainties that have limited this phase of the consent to six turbines that will allow the determination of a next, larger phase.
2. Provide monitoring data to ensure compliance with consent/ licence requirements, to inform future determination of applications and to inform the emerging tidal industry.
3. Evaluate the effectiveness and suitability of the monitoring methods, and to modify and revise when considered necessary.
4. Evaluate the effectiveness and suitability of any mitigation applied.

Condition 12 states the following aspects should be considered and advice provided regarding the monitoring of the following aspects:

- a) Hydro dynamics / benthic surveys, export cable route and turbine locations and modelling to validate EIA predictions;
- b) Collision / encounter interactions with the tidal turbines for diving birds, marine mammals and fish of conservation concern;
- c) Disturbance and displacement of birds, marine mammals and basking sharks during construction and operation. This must also link to the species protection plan for seals at haul outs; and
- d) Migratory salmonids

### 2.2 SNH Recommendations

The following table is taken from the SNH document distributed to the MeyGen AG. In some instances these represent fundamental monitoring objectives required for the development of the tidal industry.

The strategic PEMP objectives and the SNH recommendations should be reviewed in the context of the current knowledge and understanding of the receptors, monitoring technology and techniques and the size of Phase 1a (four turbines).

Receptor	Objective
Harbour seals	Collisions between harbour seals and the operational turbines, should they occur, are detected and quantified, to verify and improve the figures used in the encounter/collision rate models.
	The rate of fatal collisions <sup>3</sup> with the operational turbines, should they occur, are at level lower than the harbour seal PBR for the Orkney and North Coast Management Unit.
	To detect and quantify potential disturbance and / or displacement to harbour seals in the Inner Sound, both in the water and at haulouts, caused by the installation and operation of the MeyGen tidal array.
Other marine mammals	Collisions between marine mammals and the operational turbines, should they occur, are detected, quantified and identified to species level, to verify and improve the figures used in the encounter/collision rate models.
	The rate of fatal collisions with the operational turbines, should they occur, do not have a significant effect on the Favourable Conservation Status of the species.
	To detect and quantify potential disturbance and / or displacement to marine mammals in the Inner Sound, in the water and at haulouts, caused by the installation and operation of the MeyGen tidal array.
Fish of conservation concern	To further understand the interaction of fish, such as Atlantic salmon, with the operational turbines.
	The migratory routes of Atlantic salmon through the Inner Sound are not significantly changed as a consequence of the MeyGen tidal array installation and operation.
Seabirds (shag and black guillemot)	Collisions between diving birds and the operational turbines, should they occur, can be detected, quantified and identified to the species level.
	The installation and operation of the MeyGen tidal array does not cause significant disturbance or displacement to seabirds in the Inner Sound
Physical processes	The installation and operation of the MeyGen tidal array will not impede or modify the hydrodynamic processes in such a way that will cause change to the benthic community structure
Benthic habitats and species	The installation and operation of the MeyGen tidal array will not have a significant impact on the abundance, diversity and integrity of the benthic communities in the Inner Sound.
Noise monitoring	To monitor noise emitted from the operation tidal array and validate modelling outcomes in the ES.

Table 2.1 SNH Objectives

For each recommendation there are one or more key questions that need to be considered:

### 2.2.1 Marine mammals

MM 1	Is it possible to monitor the fine scale movements of marine mammals around tidal arrays?
MM 2	If collisions occur between marine mammals and operational tidal turbines, is it possible to quantify and identify collisions to the species level?
MM 3	If collisions occur, are these fatal (both immediate and delayed due to serious injury) to the species concerned?
MM 4	Can monitoring be used to inform marine mammal avoidance rates?
MM 5	Does the installation and operation of the tidal array have a significant impact on the abundance and distribution of marine mammals in the Inner Sound?

<sup>3</sup> Fatal collisions refer to fatalities that are immediate and delayed, and serious injuries resulting in reduced survival and / or reproduction.

### 2.2.2 Fish of conservation concern

AS 1	Is it possible to monitor the fine scale movements of fish around tidal arrays?
AS 2	If collisions occur between fish and operational tidal turbines, is it possible to quantify and identify collisions to the species level?
AS 3	If collisions occur, are these fatal to the species concerned?
AS 4	Can monitoring be used to inform fish avoidance rates?
AS 5	Is there a Fish Aggregating Device (FAD) effect and is it linked to certain tidal / meteorological conditions?
AS 6	Does the installation and operation of the tidal array have a significant impact on the migratory behaviour of Atlantic salmon in the Inner Sound?

### 2.2.3 Seabirds

SB 1	Is it possible to monitor the fine scale movements of birds diving around tidal arrays?
SB 2	If collisions occur between seabirds diving and operational tidal turbines, is it possible to quantify and identify them to the species level?
SB 3	If collisions occur, are these fatal to the species concerned?
SB 4	Can monitoring be used to inform avoidance rates for birds diving at this tidal turbine sites and other potential sites?
SB 5	Does the installation and operation of the tidal array have a significant impact on the abundance and distribution of seabirds in the Inner Sound?

### 2.2.4 Physical processes

PP 1	Does the operational tidal array have a significant impact on the hydrodynamic processes in the Inner Sound?
------	--

### 2.2.5 Benthic habitats and species

B 1	Does the installation and operation of the tidal array have a significant impact on the benthic communities found in the Inner Sound?
-----	---

### 2.2.6 Noise monitoring

N 1	Can noise measurements be taken to monitor the noise emitted from the operational tidal array to validate the outcomes of the noise modelling in the ES?
-----	--

### 3. STRATEGIC, PLANNED AND ON-GOING RESEARCH

There are a number of research work packages that have been commissioned, are on-going or are planned with the aim of improving understanding of the potential impacts of marine renewables on marine wildlife. This work will help to provide important data on the receptors that could be impacted by marine energy developments, specific impacts of concern and data collection techniques required to help understand these potential impacts.

The following section gives a review of the most relevant and prominent strategies. At the end of each section there is a review of the project and how it has helped the understanding of the questions from section 2, or could do for planned future projects.

#### 3.1 Marine Scotland Scientific Research

Marine Scotland established the Marine Renewable Energy Programme (MREP)<sup>4</sup> in 2011 to give scientific support to policy development and licensing of energy production from renewable sources.

A Research Strategy<sup>5</sup> has also been developed to show current research priorities that are planned for delivery to support the sustainable development of offshore renewable energy in Scotland's seas.

#### 3.2 Marine Scotland Demonstration Strategy: Trialling methods for tracking the fine scale underwater movements of marine mammals in areas of marine renewable energy development

As a result of a number of reports and studies on the use of technology to track the fine scale movement of marine mammals in the marine environment it has been recommended that both active and passive sonar systems are trialled for the direct observations of potential collisions with tidal turbines. The use of pinger tags on seals in association with passive sonar was also a recommendation.

The Demonstration Project research objectives are:

- *Suggest active sonar systems that would be appropriate for trialling at tidal sites.*
- *Consider the capability of Passive Acoustic Monitoring (PAM) systems and acoustic tags to track vocalising cetaceans around tidal turbines. Where required, develop and test systems for possible experimental trials.*
- *Evaluate the ability of the above technologies to detect potential collisions/impacts.*
- *Explore the capabilities of the active sonar system of choice to track other marine wildlife, specifically birds, basking sharks and migratory fish.*
- *Undertake experimental trials of the recommended technologies at high energy tidal sites to test their feasibility for direct observation of marine mammal movements. As part of the trials, consideration should be given to the logistics and technical requirements of placing these devices on, or close to, tidal devices.*
- *Following the experimental trials, develop a monitoring strategy which can be applied at high tidal energy sites. This strategy should be capable of delivery by regulators or developers. A specific strategy for an agreed site in Scottish waters should be prepared in collaboration with Marine Scotland/Marine Scotland Science.*

MeyGen has had brief discussions regarding using the Inner Sound and the Project as the basis of the trials. The project is due to commence in June 2014 and be completed by December 2015; this programme is aligned with Phase 1a, which would enable the testing of the systems and techniques in

<sup>4</sup> <http://www.scotland.gov.uk/Topics/marine/marine-environment/smrrg>

<sup>5</sup> <http://www.scotland.gov.uk/Topics/marine/marineenergy/ris>

the Inner Sound prior to turbines being installed on site. Further discussions are required on the involvement of MeyGen, but it is an excellent opportunity to meet a number of the strategic objectives.

The Demonstration Strategy provides an important step in developing and testing the technology and techniques that could be used to monitor operating turbines in the Inner Sound. The table below identifies the questions which the Demonstration Strategy scope should be able to provide data for.

MM 1	Is it possible to monitor the fine scale movements of marine mammals around tidal arrays?
AS 1	Is it possible to monitor the fine scale movements of fish around tidal arrays?
SB 1	Is it possible to monitor the fine scale movements of birds diving around tidal arrays?

The second table below identifies areas which the Demonstration Strategy might be able to provide useful information on, but these are not technically covered by the project's scope.

MM 2	If collisions occur between marine mammals and operational tidal turbines, is it possible to quantify and identify collisions to the species level?
MM 3	If collisions occur, are these fatal (both immediate and delayed due to serious injury) to the species concerned?
AS 2	If collisions occur between fish and operational tidal turbines, is it possible to quantify and identify collisions to the species level?
AS 3	If collisions occur, are these fatal to the species concerned?
SB 2	If collisions occur between seabirds diving and operational tidal turbines, is it possible to quantify and identify them to the species level?
SB 3	If collisions occur, are these fatal to the species concerned?

### 3.3 Marine Scotland research on Atlantic salmon, Sea trout and European eel

Marine Scotland Science (MSS) report, The Scope of Research Requirements for Atlantic salmon, Sea trout and European eel in the Context of Offshore Renewables<sup>6</sup>, outlines the areas of uncertainty with these species especially with regard to the novel potential impacts of marine renewable energy devices.

The following uncertainties have been identified for Atlantic salmon:

- *There is no information on the behaviour (including swimming depths, speeds and nearshore/offshore movement) of post-smolts in the Scottish context. This is a particular issue for east coast rivers and coastal areas which differ markedly in their geography from Norwegian systems.*
- *There are currently no data on the migratory routes or geographical distribution of post smolts in the North Sea.*
- *It is uncertain whether adults or post-smolts migrate through the area around Orkney and Shetland or if the Pentland Firth is the preferred or only route used.*
- *There is currently no information on the swimming depths utilised by adult fish in Scottish coastal waters.*
- *There is substantial uncertainty as to the mechanisms and routes by which adult salmon home to and around the Scottish coast to the proximity of their natal rivers.*
- *There is limited information on the timing of migration for both juvenile and adult fish for specific locations on the Scottish coast.*

A tagging study of Atlantic salmon began in summer 2013 looking at depth use in Scottish coastal waters and is summarised in section 3.4.

<sup>6</sup> | A Malcolm, J D Armstrong, J D Godfrey, J C Maclean and S J Middlemas (2013) Marine Scotland Science Report 05/13 The Scope of Research Requirements for Atlantic Salmon, Sea Trout and European eel in the Context of Offshore Renewables.

The report also identifies EMF, noise and strike as the most significant potential impacts from marine renewable energy devices. Some research, building on existing knowledge, is currently in progress:

- EMF; where, internally commissioned work is underway to provide information on the behaviour of salmon and eels in relation to EMF.
- Noise; where, a report on the ability of juvenile and adult Atlantic salmon to hear underwater noise is due for publication shortly. Further laboratory and field studies are also planned for 2014, with the aim of assessing potential implications of pile driving on Atlantic salmon behaviour and physiology. This work will be carried out throughout 2014 and reported on in early 2015.
- A project is also underway to collate available information on smolt emigration time across Scotland with a view to assessing sensitive times for offshore construction work.

MSS, is currently finalising a National Strategy report, which will provide information on the current funding and reporting timelines for each of the priority areas identified in the scoping report and from workshops with developers, conservation bodies and the wild migratory fishing industry.

MSS released a summary<sup>7</sup> of the stakeholder engagement held as part of the scoping exercise. MSS has now set up a Steering Group to develop the National Research and Monitoring Strategy for Diadromous Fish (NRMSD) with the identified priority research areas.

The NRMSD should provide strategic information on the behaviour of Atlantic salmon in the marine environment that will increase the understanding for question AS 6.

AS 6	Does the installation and operation of the tidal array have a significant impact on the migratory behaviour of Atlantic salmon in the Inner Sound?
------	--

### 3.4 Marine Scotland Atlantic salmon tagging study

In 2013 MSS began a tagging study of Atlantic salmon. The objective was to gather information on swimming depths in the North of Scotland. The Armadale netting station was used to capture and tag 50 1 Sea Winter (1SW) / Multi Sea Winter (MSW) individuals.

Pop-up satellite tags were used, programmed to detach between 1 and 10 days. They transmit when they reach the surface and get a satellite fix. The tags record depth and temperature data and a GPS fix for the location of transmission.

The project had 44 returned locations, mainly coastal but some returned to rivers and some 100km offshore (up to 55km/day travel rates). Depth range recorded show that those tagged individuals predominately inhabit the top 5m, but there was variability and all individuals undertook deep dives at some point.

MSS plan to undertake another survey in 2014 using longer deployments.

Complementary genetic research will help identify home rivers.

The study has helped prove the viability of tagging and tracking numerous Atlantic salmon helping increase the understanding of their behaviour in the marine environment and potential interaction with tidal energy projects which, will continue in 2014 (AS 6).

AS 6	Does the installation and operation of the tidal array have a significant impact on the migratory behaviour of Atlantic salmon in the Inner Sound?
------	--

<sup>7</sup> <http://www.scotland.gov.uk/Publications/2014/03/5596>

### 3.5 SMRU Seal Tagging in the Inner Sound

SMRU have tagged 19 grey seal pups and 13 adult harbour seals in the Inner Sound/Stroma.

The results indicate that the tagged grey seals show little site fidelity and are wide ranging individuals (Shetland and East Scotland).

Harbour seals show greater fidelity to the local area (the Pentland Firth and Orkney waters) however there is a highly individual pattern to foraging (some exclusively Pentland Firth, others west coast of Orkney). Within the Pentland Firth individuals have shown foraging behaviour varying between extensive use of the tidal areas, to using a narrow strip of coastal waters very close to shore.

The tagging study has provided valuable data on harbour and grey seal behaviour and also provides information and experience for future tagging work for more project specific needs with regard to MM 1 and MM 5.

MM 1	Is it possible to monitor the fine scale movements of marine mammals around tidal arrays?
MM 5	Does the installation and operation of the tidal array have a significant impact on the abundance and distribution of marine mammals in the Inner Sound?

### 3.6 SMRU - Active Sonar at Siemens/MCT Strangford Loch

SMRU were contracted to review off the shelf sonar systems, with potential to detect marine mammals underwater. Only 5 out of 228 systems (from 39 manufacturers) met the specification and only 2 were interested in cooperating in research and development of their system (BioSonics DTX and Tritech Gemini).

SMRU completed behavioural response tests with grey seals, during which, the BioSonics system elicited a strong aversive reaction; apparently linked to the wide frequency band that the system produced along with the nameplate frequency.

The Tritech Gemini was selected for further development and application at the SeaGen turbine in Strangford Loch. Development included producing systems to increase the accuracy/reliability of detections, classifications and tracking of marine mammals; with the secondary objective of significantly reducing the amount of data produced and resources required to analyse that data.

Detection probability for seals was high at up to 30-40m beyond which detection rates dropped off significantly.

Classification of a target was tested and the system produced false positives and false negatives; there were a large number of mobile targets (20/hour) that did not appear to be marine mammals and which, the classification system would therefore need to discriminate.

The Strangford Loch system was attached to the pile of the SeaGen turbine looking out in one direction. Sonar swathe was limited at 120° horizontal and 20° vertical, therefore coverage was not 100% and the system was not able to cover the turbine blades.

The system was able to reduce the amount of data produced with autonomous detection and classification however; data volumes were high and will need to be reduced further for a longer period of deployment.

Recommendations for the future:

- Validation of detection and classification – ground truthing;
- Further software development for classification and kinematic modelling (reconstructing tracks);
- Further development of species classification (e.g. harbour and grey seal); and
- Development of a true 3D tracking system.

The system at Strangford Loch provided evidence that active sonar could provide valuable data on the near field interactions of marine mammals around a tidal turbine (MM 1). It also provided a benchmark and recommendations to improve the system for future deployments.

MM 1	Is it possible to monitor the fine scale movements of marine mammals around tidal arrays?
------	---

### 3.7 FLOWBEC – NERC funded Consortium led by NOC

The project built a self-contained, portable unit that can sample and monitor hydrodynamic conditions and biological activity over a full neap/spring 2 week cycle at up to 8 measurements a second. Five 2 week deployments were completed at the EMEC wave and tidal site in Orkney. The unit was deployed in front of the non-operating OpenHydro turbine and the Atlantis substructure (no turbine present) at the EMEC tidal site.

Contained:

- 3 EK60 echosounders (38, 120, 200Hz), for bird and fish abundance, school behaviour;
- Multibeam sonar; interactions of fish, diving seabirds, marine mammals with renewable energy devices, target tracking, avoidance behaviour;
- ADV, current and temperature; and
- Fluorometer for plankton.

Multibeam sonar was selected to be low-budget, low-data-rate, low-battery-power, which gives a lower quality image than other systems but this permits a self-contained power and data unit. The EK60s are able to increase the power of target detection with the multibeam able to track diving birds feeding beneath shoal of fish.

The FLOWBEC system has been able to provide data on the use of vertical water column that would increase the understanding of collision risk for sensitive receptors.

If the system was deployed prior to installation and during operation, it should also detect changes in habitat usage for sensitive receptors.

Further development could allow synchronisation and intelligent triggering of instruments across multiple scales:

- Combines large-scale with fine-detail (low power multibeam with camera system for collision detection)
- Reduces data processing / archival
- Co-registered, synchronised datasets
- Cycle passive / active acoustics

FLOWBEC has provided evidence that active sonar could provide valuable data on the near field interactions of diving birds around a tidal turbine (SB 1). The use of the EK60s also meant that shoaling fish could be tracked and identified (AS 1 & AS 2). It also provided recommendations to improve the system for future deployments.

AS 1	Is it possible to monitor the fine scale movements of fish around tidal arrays?
AS 2	If collisions occur between fish and operational tidal turbines, is it possible to quantify and identify collisions to the species level?
SB 1	Is it possible to monitor the fine scale movements of birds diving around tidal arrays?



### 3.8 EMEC Integrated Monitoring Pod

Under the ReDAPT project (funded by ETI), EMEC has designed, built and operated an integrated environmental monitoring pod.

The unit is cabled to shore and includes real-time measurement equipment for currents, directional acoustics, temperature, salinity, turbidity and a bespoke sonar system, linked to output from device-mounted video camera. A cabled system was chosen in order to facilitate long-term 24/7 real-time data collection.

The unit was successfully commissioned and operated for an initial six months. It was then retrieved from the deployment site and is now no longer part of the ReDAPT project, having been transferred to EMEC ownership.

EMEC has secured funding for further development of the system from the Marine Renewables Commercialisation Fund (MRCF) array technology innovation programme. The funds are to review the technology to be installed on the pod, implement some upgrades, redeploy the pod, collect the data and analyse.

The EMEC platform will be another integrated monitoring system that will help understand the fine scale movement of potentially all sensitive receptors (MM 1, AS 1 & SB 1).

MM 1	Is it possible to monitor the fine scale movements of marine mammals around tidal arrays?
AS 1	Is it possible to monitor the fine scale movements of fish around tidal arrays?
SB 1	Is it possible to monitor the fine scale movements of birds diving around tidal arrays?

### 3.9 Black Guillemot and Shag tagging – Dr Elizabeth Masden, Environmental Research Institute

#### *Black Guillemot*

Objective was to assess habitat use and potential overlap with proposed tidal turbines using GPS (i-gotU/Ecotone) and TDR (Cefas G5) tags on Black guillemot from Stroma (2011/12).

The project had limited success with not many tags recovered or data retrieved. Data that was recovered showed individuals taking dives to an average depth of 32m and maximal dive duration of 131 seconds. The Ecotone GPS tags show individuals travelling a maximum distance of 7.6km from the nest.

Lessons learnt regarding the practicalities of tagging Black guillemot on:

- Size of tags available
- Trapping and re-trapping
- Attachment methods
- Weather and locations of nests on Stroma

An RSPB Black guillemot project on Shapinsay learnt from ERI experience:

- Used Ecotone base station
- Remote download of data
- Smaller GPS loggers from Ecotone
- 8 birds tracked from 10 tags, 2 immature and 6 adults
- Tracked for up to 10 days

### Shag

Objective was to assess habitat use and potential overlap with proposed tidal turbines using GPS (i-gotU) and TDR (Cefas G5) tags on Shag from Stroma (2012/13).

The project had limited success with not many tags recovered or data retrieved. Data is being analysed against tidal data.

The two studies have showed the difficulty of tagging these particular species, but there is confidence now that having gone through this process that there is a more robust system that will provide data on individual tracks and dive depths.

The study has begun to show that tagging of these key species is feasible, with populations accessible close to the site. This provides an opportunity for future tagging work either in relation to collision risk (SB 1) or disturbance and displacement (SB 5)

SB 1	Is it possible to monitor the fine scale movements of birds diving around tidal arrays?
SB 5	Does the installation and operation of the tidal array have a significant impact on the abundance and distribution of seabirds in the Inner Sound?

### 3.10 Pentland Firth Initiative – University of Highland and Islands (Professor Stuart Gibb)

The project, based in the Environmental Research Institute, will focus on the migratory patterns of the species in the Pentland Firth, a key area for the salmon and the location of a series of major marine renewable developments.

*The initial focus of the study will be on mapping salmon migration in northern coastal waters. The project will use new information on the complex water movements in this region to help with this. As part of the research, scientists will collect field data on the effects the construction and operation of marine renewable energy developments may have on the fish's behaviour. They will seek to find out if noise and other aspects affect the species<sup>8</sup>.*

As part of the research, scientists will collect field data on the effects the construction and operation of marine renewable energy developments may have on the fish's behaviour. They will seek to find out if noise and other aspects affect the species.

The priority for the initiative is to better understand Atlantic salmon migration in the Pentland Firth region (AS 6)

AS 6	Does the installation and operation of the tidal array have a significant impact on the migratory behaviour of Atlantic salmon in the Inner Sound?
------	--

### 3.11 Particle tracking to simulate Atlantic salmon movement in the Pentland Firth – Dr Andrew Guerin, Environmental Research Institute<sup>9</sup>

The main objective of the project was to assess whether particle tracking models (PTMs) represent a viable approach for estimating the potential for interactions between salmon and renewable energy developments, particularly in the Pentland Firth.

The project conducted a PTM demonstration looking at the returning migration of adult salmon through the Pentland Firth to the east coast rivers. It concluded that it was a viable method to inform the probability of salmon passing through a specific tidal energy site, encounter risk with turbines and the cumulative impact of multiple sites.

<sup>8</sup> <http://www.northhighland.uhi.ac.uk/study-to-explore-impact-of-marine-renewables-on-iconic-fish>

<sup>9</sup> Guerin, A.J., Jackson, A.C., Bowyer, P.A. and Youngson, A.F. 2014. 'Hydrodynamic models to understand salmon migration in Scotland.' The Crown Estate, 116 pages. ISBN: 978-1-906410-52-0.

The PTM has several advantages for estimating likelihood of passage through development sites:

1. A range of underlying hydrodynamic models may already be available.
2. In the absence of empirical data, modelling would allow exploration of the effects of different behaviours and tidal or meteorological conditions on encounter rate.
3. Modelling may allow hydrodynamic changes resulting from turbine operation to be predicted.
4. The approach has potential to generate hypotheses for testing in the field.

Several improvements are suggested that would be required to develop this approach into a useful tool for impact assessment, including collection of empirical data to support the models. PTMs could start to use data from the more recent tagging projects to improve the behavioural data used in the PTM. This approach would help answer AS6.

AS 6	Does the installation and operation of the tidal array have a significant impact on the migratory behaviour of Atlantic salmon in the Inner Sound?
------	--

### 3.12 Seal haul-out counts - SCOS<sup>10</sup>

SMRU carries out surveys of harbour seals and grey seals to contribute to the Natural Environment Research Council's (NERC) statutory obligations under the Marine (Scotland) Act 2010 and the Conservation of Seals Act 1970. SMRU use various methods for haul-out counts.

#### *SMRU Harbour seal moult surveys*

##### Helicopter surveys

This method is generally applied to survey parts of the Scottish coast each year and produces a complete estimate for the whole of Scotland approximately every five years. During the harbour seal moult in August, helicopter surveys are carried out using a thermal imager and is equipped with a dual telescope (x2.5 and x9 magnification).

A digital video camcorder, attached to the imager, provides a real colour image to match the thermal image. Both images are displayed continuously on a monitor placed in front of the camera operator and simultaneously recorded to a digital video recorder. Seals are detected and counted on the monitor using the thermal image. For each sighting the location, time, species and number of seals are recorded directly onto Ordnance Survey 1:50 000 maps.

Since 2006, most groups of seals are also photographed using a digital SLR camera equipped with an image-stabilised 70-300mm lens. In general, differentiating between harbour and grey seals using a thermal image is possible on account of their different thermal profile, size and head-shape. When hauled out, their group structure also differs.

To maximise numbers counted, surveys are carried out no more than two hours before or after the local low tide times occurring between approximately 12:00 and 17:30hrs local time. To further reduce the effects of environmental variables on number of seals counted, surveys are not carried out on rainy days. The thermal imager cannot 'see' through heavy rain and seals often abandon their haul-out sites and return to the water in medium to heavy prolonged rain.

##### Fixed-wing surveys

Certain areas on the east coast of Scotland (mainly the Moray Firth but also the Tay and Eden estuaries) are surveyed almost annually using fixed-wing aircraft, if not covered by the helicopter survey. The major seal haul-out sites in these areas are well known. They are often situated on sandbanks making it easier to spot seals without the help of a thermal imager. All groups of seals are photographed through the aircraft's side windows using a handheld digital SLR camera and recorded onto paper maps.

<sup>10</sup> SMRU (2012) Scientific Advice on Matters Related to the Management of Seal Populations: 2012

As described above for helicopter surveys these fixed-wing surveys are only carried out within certain tidal windows and in suitable weather conditions.

**SMRU grey seal pup surveys**

Grey seals return each year to traditional colonies to breed. Not only do females return to the same location within a colony, but they regularly return to the colony at which they were born. The timing of breeding varies around the Scottish coast. In each area, breeding occurs over approximately two months, with individual pups remaining on their breeding colony for approximately five weeks before departing to sea. A series of up to five aerial surveys are flown over the main breeding colonies by fixed-wing aircraft, at intervals of 10 to 13 days (weather permitting). Pups are counted from high resolution vertical aerial images and a maximum likelihood model is used to estimate the total number of pups born at each colony from the series of counts. Annual surveys were carried out up to 2010 and biennial surveys are continuing.

Regular haul out counts could provide context to other aspects of the monitoring programme in identifying disturbance and displacement impacts from construction and potentially operation (MM 5).

MM 5	Does the installation and operation of the tidal array have a significant impact on the abundance and distribution of marine mammals in the Inner Sound?
------	--

**3.13 Strandings Data<sup>11</sup>**

The Scottish Marine Animal Stranding scheme (SMASS) has provided information on marine mammal strandings since 1992. The scheme provides information on the cause of death of stranded animals, and patterns in the number, frequency and character of observed mortality. Strandings data contains biases, but identification and examination of carcasses at post mortem is the only way of establishing a definitive cause of death or proof of direct trauma.

SMASS currently monitors stranded marine animals through projects funded by Marine Scotland and Defra. This covers the running costs of a passive surveillance network and funds a strandings co-ordinator and veterinary pathologist. Cases are reported by members of the public, institutions and NGO's, however, as with all opportunistic collected data, this suffers from low survey effort in sparsely populated coastal areas. To use strandings to measure trend, some index of survey effort is required. The Pentland Firth and Orkney are two areas with a lower than expected incidence of reported strandings. A potential solution would be to actively monitor target areas within these reporting 'data holes' by regular surveys of sentinel beaches to detect stranded animals.

Identification of sentinel beaches, i.e. sites which are logistically and scientifically sensible locations to monitor is advised; however a reliable baseline is required against which any subsequent change can be measured.

Scotland has had a stranding scheme in operation for over two decades ([www.strandings.org](http://www.strandings.org)) and the scheme is developing strategies to incorporate active monitoring into the current passive surveillance work. Consequently, any additional costs from the marine development industry would only be required for additional staff time rather than any substantial logistic or infrastructural investments.

SNH had previous scoped work for Marine Mammal Strandings Scheme for Orkney and the Pentland Firth (Brownlow 2011, unpublished report to SNH). SNH are now considering options for a PFOW scheme, which would be contingent on securing a partnership with MS, TCE and/or industry.

Post-mortem examination of stranded mammals may provide proof of collision events if they were to occur (MM 3). However, there is uncertainty regarding the feasibility of such a scheme given the size of Phase1a and the potential range of stranding sites that would need to be covered.

MM 3	If collisions occur, are these fatal (both immediate and delayed due to serious injury) to the species concerned?
------	---

<sup>11</sup> A Brownlow, Scottish Marine Animal Stranding Scheme (2014); Integration of marine stranding data into impact monitoring systems for marine renewables developments.

### 3.14 Strangford Lough Benthic Habitats Survey<sup>12</sup>

Strangford Lough is a Special Area of Conservation (SAC) and the subtidal reef is an Annex 1 (Habitats Directive) feature.

Four quadrat stations were established by installing Ultra Short Baseline (USBL) transceivers. Three stations were placed in line with the rotational axis of the east turbine at 20m, 150m and 300m to the south-east of the turbine installation. A further single reference station was installed approximately 50m to the ENE of the turbine. Still photography and digital video were used to record each cell of the quadrats. Percentage cover of each quadrat cell was recorded and classified. 1 pre-installation and 4 post-installation surveys were completed and then analysed for statistical differences between the samples.

The community changes across all stations within the downstream influence of the SeaGen turbine were broadly similar over time and are largely mirrored in the reference station. Sampling times have been found to be the most significant factor regarding differences in benthic communities. Changes observed represent random spatial variation that encompasses disturbance, competition and succession. In general, all of the stations sampled have shifted in community structure in a manner that matches the reference station.

The use of divers on the MeyGen site is to be limited to an absolute minimum during installation and operation. It is unlikely therefore that this method would be suitable in the Inner Sound given that it is in deep water and a more energetic site. The use of drop down cameras would not be feasible for the level of accuracy required for this type of survey, therefore it would need monitoring to consider larger scale benthic biotope change.

The Strangford Lough benthic monitoring provided valuable information on potential impacts on benthic habitats (B 1) and also some of the practical challenges of monitoring and detecting change in this environment.

B 1	Does the installation and operation of the tidal array have a significant impact on the benthic communities found in the Inner Sound?
-----	---

### 3.15 RESPONSE – NERC funded study led by SMRU at the University of St Andrews (Dr David Thompson)

The marine mammal aspect of RESPONSE was set up to address information gaps for potential impacts from marine renewables:

- Barrier effects due to acoustic disturbance; and
- Risk of collision

In 2013, the response of seals to tidal turbine noise playbacks (from Strangford Loch) was tested using high resolution telemetry and visual observations. Data is being analysed but the belief is that any change in behaviour identified will be subtle.

RESPONSE assessed encounter risk using high resolution telemetry and the proposed positions of four turbines in Kyle Rhea. GPS and dive depth recorders were used to identify when individuals crossed through these areas. Data shows highly structured use of the Kyle Rhea tides, with highest activity during the flood tide, lower activity on the ebb and use of the haul-outs during slack tides (high and low water).

RESPONSE have provided valuable data on use of the Kyle Rhea tidal regime, whether this is transferable to the Inner Sound is uncertain, however it has also given greater understanding and experience for future tagging studies (MM 1 & MM 5).

<sup>12</sup> Royal Haskoning (2011) SeaGen Environmental Monitoring Programme Final Report

MM 1	Is it possible to monitor the fine scale movements of marine mammals around tidal arrays?
MM 5	Does the installation and operation of the tidal array have a significant impact on the abundance and distribution of marine mammals in the Inner Sound?

### 3.16 EMEC Harbour seal haul-out monitoring 2010<sup>13</sup>

Several installation operations were scheduled for the EMEC Falls of Warness site during summer 2010. These included EMEC cable laying operations using the SV-Sovereign Dynamic Positioning (DP) cable laying vessel; the installation of Atlantis' AK1000 turbine and gravity base foundation using the Skandi Skolten (DP vessel) and Voith Hydro Ocean Current Technologies' monopile drilling from a jack-up vessel (although the drilling works did not go ahead during this observation period in the end).

EMEC undertook seal haul-out monitoring at Seal Skerry, Seal Skerry Point to help understand the impact of DP vessel noise and monopile drilling noise on harbour seal. The survey area was intensively observed for two watches per day for the duration of the noisy works. During each of the week preceding and the week following works, the watch intensity was lowered to a rate of two watches per week, undertaken on separate days.

The total observation time for the programme was 107.5 hours. The total number of records entered was 438.

The observational results contain seven events when harbour seals on Seal Skerry and/or Seal Skerry Point displayed anxious or disturbed behaviour:

1. Gann's tannoy voice (cruise ship) disturbed the seals
2. Tidal Cable 1 repair by CS Sovereign
3. Vessels Enbarr and RIB not associated with works covered in this report
4. Vessels Enbarr and RIB not associated with works covered in this report
5. One man and a boy walking around the point but staying on the grass
6. One man walking, went quite close to seals, walking on rocks and taking photographs
7. Seals disturbed by the rising tide

As the results show little variation in harbour seal behaviour over the period of the observations programme, SMRU advised against undertaking any statistical analysis. Any relationship between vessel activity during the works and harbour seal behaviour presented in the results is the observer's opinion.

The EMEC monitoring programme has provided data on the potential noise impacts on hauled out harbour seals during the pupping season. Although no statistical analysis was completed, the evidence from the surveyor was that there was little observed behavioural change in reaction to the works.

MM 5	Does the installation and operation of the tidal array have a significant impact on the abundance and distribution of marine mammals in the Inner Sound?
------	--

<sup>13</sup> Supplementary Environmental Monitoring EMEC Fall of Warness tidal test site Harbour Seal Land-Based Visual Monitoring Report October 2010

## 4. MONITORING TECHNOLOGY AND TECHNIQUES

### 4.1 Active Sonar

Active sonar provides the best opportunity to monitor multiple receptors in the near field environment of the turbine blades. There have been several systems that have been developed and tested (SMRU at Strangford Loch, FLOWBEC, ReDAPT).

Active sonar is likely to provide fine scale data on the behaviour of some receptors in the near-field environment, such as marine mammals. There is uncertainty as to whether it can provide data on collision events, a receptor passing through the turbine swept area and critically identification of a receptor to a species level. For this reason, active sonar should not be considered as a stand-alone system. Other systems that could complement active sonar are considered in section 4.4 and 4.5.

Limitations and potential development requirements are considered further below.

#### *Active sonar frequency*

Different frequencies may be better at detecting different receptors. The correct frequency or frequencies need to be chosen to maximise the effectiveness of the system, whilst eliminating or minimising frequencies that would have an adverse impact on the receptors (aversion or attraction from the device).

#### *Collisions with the turbine*

Further research is required to understand whether active sonar can detect collisions. It is thought that an object would be lost in the turbulence and data noise created from the rotating turbine blades.

#### *Consequence of collision*

Active sonar is unlikely to be able to definitively detect the consequence of a collision between a turbine blade and receptor.

#### *Species identification*

Further research is required to understand whether active sonar can detect receptors to a species level. It is especially important to identify between grey and harbour seal given the conservation status of the later and also whether a system can detect and identify Atlantic salmon. Discrimination of different bird species does not appear feasible at present.

#### *Detection rates and range*

Technology and programmes have had limited success at automatic detection and tracking of receptors. Detections are limited to 30-50m where rates start to reduce significantly.

Active sonar are limited to a relatively narrow beam (Strangford Loch - 120° by 20°) thereby requiring multiple systems to cover a whole turbine or turbines.

#### *Data handling*

Automatic detection and tracking would considerably reduce manual data handling and processing.

### 4.2 Passive Acoustics and Pinger Tags

Passive acoustics has been widely used for surveying vocalising cetaceans. It is now being applied to track individuals in 3D using a network of hydrophones. The same technology and techniques can be applied to other species if they are carrying a pinger tag. It was suggested at the AG workshop that pinger tags are relatively cheap and can be of a suitable size for most species.

A hydrophone has a greater detection range compared to active sonar, which means it can be used to;

1. monitor near-field and medium scale disturbance and displacement;
2. provide a more complete and comprehensive coverage of the water column surrounding the turbine(s).

### *Pinger tag attachment*

It has been showed by the Marine Scotland Salmon tagging study and ERI's Black guillemot study that catching individuals and attaching tags requires considerable resource and experience.

### *Individual fidelity for the Inner Sound*

Selected individuals that are tagged may show limited fidelity to the Inner Sound. There is data to suggest that local populations of harbour seal and black guillemot show relatively good site fidelity, whilst others are migratory or have a considerably greater range. Further consideration would be required to understand the sample size of each species population that would potentially yield statistically robust results.

For those migratory or longer range species the best approach may be to have a short intensive monitoring period.

### *Risk of increased predation*

There is a risk that the frequency output of the pinger could be detected by predators, increasing the risk to the individual. Tags would need to be carefully selected to reduce this risk.

## **4.3 Positioning and Depth-Time Recorder Tags**

GPS, TDR tags and variations thereof have been used in a number of applications with all the sensitive receptors. These can provide very accurate behaviour data of the individual tagged, however they can be prohibitively expensive and weight can be an issue.

The same issues with tag attachment and site fidelity can be assumed for GPS / TDR tags as with pinger tags.

Given the strategic objectives are primarily interested in data to help understand collision risk then GPS/TDR may have limited use in comparison to other study options.

## **4.4 Video and Still Cameras**

Video or still cameras could provide supplementary data on collision events, receptors passing through the turbine blade swept area and aid species identification.

Cameras are limited by visibility (low level light, water turbidity) however they should provide accurate robust data when conditions permit. The idea of using a lamp or flash has been considered previously however, there may be a risk of receptors being attracted to the light source.

There is the potential to link them to an acoustic system to turn on when a receptor is detected so there is a reduction in the amount of data produced by a system.

The Andritz Hammerfest Hydro 1MW turbine has 3 cameras mounted on the nacelle. They have provided data for several months and have not shown any sign of bio-fouling yet. Underwater video cameras have also been used extensively to monitor fish presence and behaviour around Open Hydro's turbine at Fall of Warness.

Positioning of the cameras would be important to maximise the coverage of the blades swept area. Cameras placed below the turbines viewing up to the surface may provide greater clarity, silhouetting the turbine blades.

Other camera technology could be investigated such as thermal imaging cameras.



## 4.5 Blade-mounted Technology

There was discussion at the AG workshop regarding their potential of blade (or near to) mounted technology to detect collisions. These systems include:

- Cameras at the hub
- Strain gauges
- Hydrophones
- Pressure pads

All would require research and development to understand their potential, however it should be noted that any equipment forward of the nacelle in the hub or on the blades would require an electrical connection through a slip ring or similar to get data and power from the rotating section to the static section, these can be unreliable.

To date there has been limited success with strain gauges on blades.

Scotrenewables Tidal Power Ltd. monitoring their SR250 device using hydrophones attached to the superstructure of the turbine. Audio files were checked for unusual occurrences by batch processing using code, then cross referencing to the relevant date time stamped video. There has been no indication of a collision during the SR250 trials. The plan is to include hydrophones in the hub on the SR2000, currently being developed (Prof. J. Side, ICIT, Heriot Watt University per comms. 17<sup>th</sup> March 2014).

It is understood that there has been no work done with pressure pads to date.

## 4.6 Current Profilers

There are several types of current profiles available:

- Acoustic Doppler Current Profiler (ADCP)
- Acoustic Wave and Current profiler (AWAC)
- Acoustic Doppler Velocimeter (ADV)

ADCP measurements were used to produce and validate the MeyGen hydrodynamic model. Data for energy extraction from the turbines has been estimated using computational fluid dynamics and used in the hydrodynamic model to give energy yields. This model was used for the physical processes impact assessment and the deployment of current meters with the operating turbine will help valid these models.

Current data is time stamped so it can be easily integrated into a larger system of sensors so that receptor detection can be compared against states of the tides etc.

Another workstream of the FLOWBEC project used marine radar to monitor tidal vectors over the Inner Sound. Although not as accurate as point measurement current profilers, it does give real data on a far greater area (range up to 4.8km), rather than relying on hydrodynamic model predictions validated by point measurements.

## 4.7 Hydrophone - turbine noise

There are a number of systems available for measuring ambient marine noise and turbine signatures. MeyGen collected baseline noise measurements over the tidal cycle in the Inner Sound from a drifting hydrophone array; turbine noise parameters were taken from available literature to complete the assessment.

The survey of the Inner Sound when the turbines are operating over a given tidal cycle will help valid the model and conclusions of the EIA.

#### **4.8 Population monitoring**

See section 3.12 and 3.16

#### **4.9 Strandings Scheme**

See section 3.13

## 5. PEMP OBJECTIVES

### 5.1 Draft PEMP Objectives

The PEMP objectives for monitoring are based on:

1. Conditions of consent;
2. The SNH recommendations;
3. The current understanding of receptor behaviour and environmental impacts from tidal turbines and other proxy industries;
4. The current and planned research with regard to tidal turbine impacts (summarised in section 3) and how these fit with the strategic objectives and questions; and
5. The current understanding of monitoring technology and techniques (summarised in section 4).

Each objective has also been assigned a priority status, which is designed to aid the development of the PEMP. The levels of priority are shown in Table 5.1.

Priority	Description
1	Both receptor and impact are high priority
2	Either the impact or receptor is high priority
3	The impact on the given receptor is of medium priority
4	The impact or receptor are of low priority

Table 5.1 Monitoring priority levels

When developing monitoring technology and techniques for the PEMP, these priorities should be considered. For example; it is of the highest priority that potential collisions between harbour seals and the turbines are identified. In doing so, the technology and techniques that are likely to be engaged will also provide opportunities to monitor collision with other species. Given the population status of the harbour seal it is important to try and accurately identify the species when monitoring for collisions, this may include tagging a proportion of the local population. Whilst a collision monitoring system would also pick up other species including grey seals; given the lower priority status of grey seal and the observed low site fidelity, the value of a similar tagging study for grey seal will need to be considered.

The objectives to detect receptor avoidance and collisions and disturbance/displacement in the water and at haulouts have been split out in this section as they pose slightly different challenges for the monitoring technology and techniques and the data that would be collected.

Data requirements will be reviewed and adjusted based on the technology and techniques developed and then used in the PEMP.

#### 5.1.1 Harbour seal

Receptor	Objective	Technology/Technique Option	Data	Limitations	Priority
Harbour seal	To detect and quantify potential avoidance rates. Verify and improve the accuracy of collision/encounter rate models.	Active sonar; Passive acoustics (with pinger tags); GPS tags; HD camera.	No. of behavioural reactions per identifications near the turbine.	Species identification.  Range and coverage	1
	To detect and quantify collision rates. Verify and	HD camera/hydrophone Active sonar; Passive acoustics (with pinger	No. of collisions per identifications	Identification of a collision. Species	1

	improve the accuracy of collision rate models.	tags). Potentially GPS tags	near the turbine	identification. Fidelity of individual to site. Number of individuals available to tag.	
	To detect and quantify potential disturbance and / or displacement in the water during operation.	Passive acoustics (with pinger tags); GPS tags.	Data with power to detect change in distribution and behaviour	Fidelity of individual to site. Number of individuals available to tag.	2
	To detect and quantify potential disturbance and / or displacement at haulouts, during construction.	Haulout observations and counts.	Observations of behavioural response		2

It must be noted that if fatal collisions between harbour seal and turbine blades were to occur it would be important to ensure that they are at level lower than the harbour seal PBR for the Orkney and North Coast Management Unit taking into account the share of the PBR taken up by licences for fishing and netting. To this regard, the technology or technique should be able to give an indication of whether the collision occurred and whether it was fatal or not.

From the current and on-going research there are two systems that could be used to track and monitor harbour seals in the turbine near field environment (active and passive acoustics), however neither are likely to be able to provide the data on actual collisions, therefore a complementary systems (e.g. video camera) must be included.

Haul out monitoring during construction should be considered when there are works in proximity to the identified sites; this depends on the final construction method.

### 5.1.2 Grey seal

Receptor	Objective	Technology/Technique Option	Data	Limitations	Priority
Grey seal	To detect and quantify potential avoidance rates. Verify and improve the accuracy of collision/encounter rate models.	Active sonar; Passive acoustics (with pinger tags); GPS tags; HD camera.	No. of behavioural reactions per identifications near the turbine.	Species identification.	2
	To detect and quantify collision rates. Verify and improve the accuracy of collision rate models.	HD camera/hydrophone. Active sonar; Passive acoustics (with pinger tags). Potentially GPS tags.	No. of collisions per identifications near the turbine	Identification of a collision. Species identification. Fidelity of individual to site. Number of individuals available to tag.	2
	To detect and	Passive acoustics (with	Data with	Fidelity of	3

	quantify potential disturbance and / or displacement in the water during operation.	pinger tags); GPS tags.	power to detect change in distribution and behaviour	individual to site. Number of individuals available to tag.	
	To detect and quantify potential disturbance and / or displacement at haulouts, during construction.	Haulout observations and counts.	Observations of behavioural response		3

The system used for harbour seal could be efficient for grey seal as well. As discussed in the introduction to section 5.1, the value of attempting to tag grey seal individuals will require consideration.

### 5.1.3 Cetaceans

Receptor	Objective	Technology/Technique Options	Data	Limitations	Priority
Harbour porpoise	To detect and quantify potential avoidance rates. Verify and improve the accuracy of collision/encounter rate models.	Active sonar; Passive acoustics; HD camera	No. of behavioural reactions per identifications near the turbine	Species identification.	2
	To detect and quantify collision rates. Verify and improve the accuracy of collision rate models.	HD camera/hydrophone Active sonar; Passive acoustics.	No. of collisions per identifications near the turbine	Identification of a collision. Species identification.	2
	To detect and quantify potential disturbance and / or displacement in the water during operation.	Passive acoustics	Data with power to detect change in distribution and behaviour		3

As the most common cetacean in the Inner Sound, harbour porpoise represent the cetacean element in the monitoring programme. The monitoring methods identified for harbour seal would also be beneficial for cetaceans albeit with a passive acoustic network there would be no need for pingers tags and the use of positioning tags was not considered feasible at this stage given the difficulty in tagging cetaceans. Species identification will remain an issue with an active sonar/camera system.

### 5.1.4 Migratory salmonids

Receptor	Objective	Technology/Technique Options	Data	Limitations	Priority
Atlantic salmon	To detect and quantify potential avoidance rates. Verify and improve the	Active sonar; Passive acoustics (with pinger tags); GPS/TDR tags; HD camera	No. of behavioural reactions per identifications near the	Species identification. Fidelity of individual to site.	2

	accuracy of collision/encounter rate models.		turbine.	Number of individuals available to tag.	
	To detect and quantify collision rates. Verify and improve the accuracy of collision rate models.	HD camera/hydrophone; Active sonar; Passive acoustics (with pinger tags).	No. of collisions per identifications near the turbine	Identification of a collision. Fidelity of individual to site. Number of individuals available to tag.	2

Migratory salmon provide a different challenge than work on seal and cetacean species. There is relatively little known regarding their marine and migratory behaviour. The on-going and planned research by MSS (section 3.3) and the Pentland Firth Initiative (section 3.10) should improve the relative understanding of behaviour, spatial distribution and swim depth in the marine environment.

Given the uncertainty regarding active sonar/camera identification of Atlantic salmon, it should not be solely relied upon to provide data on encounters or collisions. Tagging studies would provide an opportunity to provide accurate information about individual behaviour. However, given the large population size and lack of data on migratory patterns there may need to be a significantly large number of tagged individuals to provide robust data. A feasibility study for both active sonar, passive (+tags) and positioning tags will be required in coordination with the MSS programme.

### 5.1.5 Diving birds

Receptor	Objective	Technology/Technique Options	Data	Limitations	Priority
<b>Seabirds (shag &amp; black guillemot)</b>	To detect and quantify potential avoidance rates. Verify and improve the accuracy of collision/encounter rate models.	Active sonar; Passive acoustics (with pinger tags); GPS tags; HD camera.	No. of behavioural reactions per identifications near the turbine.	Species identification.	2
	To detect and quantify collision rates. Verify and improve the accuracy of collision rate models.	HD camera/hydrophone; Active sonar; Passive acoustics (with pinger tags).	No. of collisions per identifications near the turbine	Identification of a collision. Species identification. Fidelity of individual to site. Number of individuals available to tag.	2
	To detect and quantify potential disturbance and / or displacement in the water, during operation.	Passive acoustics (with pinger tags); GPS tags.	Data with power to detect change in distribution and behaviour	Fidelity of individual to site. Number of individuals available to tag.	3

The system used for harbour seal could be efficient for diving bird species as well.

### 5.1.6 Physical processes

Receptor	Objective	Technology/Technique	Data	Limitations	Priority
----------	-----------	----------------------	------	-------------	----------

		Options			
<b>Physical processes</b>	Validate and improve the accuracy of the physical processes model and associated environmental impacts	Current meter	Hydrodynamic data from in front and behind turbines on energy extraction and turbulence.		4

### 5.1.7 Benthic Habitats

Receptor	Objective	Technology/Technique Options	Data	Limitations	Priority
<b>Benthic habitats</b>	Validate the benthic environmental impact assessment				4

It is proposed that there is no benthic habitat monitoring for Phase 1a of the Project. The MeyGen EIA concluded that there were no likely significant impact on benthic habitats and communities and given that only four turbines will be deployed there is uncertainty that any survey would have the power to detect a significant change. Results from Strangford Loch (a designated SAC for subtidal reef) concluded that there was no discernible change over the two year period (section 3.14).

As described in section 3.14, divers are not recommended for these surveys in the Inner Sound and drop down cameras would not be feasible for quadrat surveys. The only other option currently available would be to monitor for larger scale benthic biotope change. Given that Phase 1a is only four turbines, it is unlikely that impacts will be identified at this scale.

It is proposed that benthic monitoring objectives are reviewed following the results of the physical processes monitoring and when further turbines are deployed at the site.

### 5.1.8 Turbine noise

	Objective	Technology/Technique Options	Data	Limitations	Priority
<b>Noise</b>	Validate and improve the accuracy of the noise model and associated environmental impacts	Hydrophone	Noise data from operating turbines in different tidal states.		4

## 6. ADVISORY GROUP RECOMMENDATION FOR MONITORING

Based on the objectives and priorities in section 5 the following recommendations are made by the MeyGen Advisory Group for monitoring Phase 1a of the project. Whilst the highest priority is to monitor harbour seals, the technology used will be capable of monitoring other receptors. Additional technology can be considered that would enhance the capability of the monitoring programme; these can be assessed in terms resource requirements, cost and meeting other monitoring objectives given their priority status.

In making these recommendations and setting out the objectives in section 5 the AG is carrying out its main function of providing advice and oversight of the content of the PEMP and thereby agreeing that these conform to the consent conditions.

### 6.1 Active Sonar and complementary technology

Active sonar provides the most comprehensive opportunity to capture fine-scale behaviour for all receptors around the turbines over temporal and spatial scales.

System design will be important to a robust monitoring programme. It has been identified that a system facing the turbine provides the best opportunity to capture the whole of the rotor swept area, however this brings with it challenges for power and data handling.

Active sonar may not however, have the capability to detect collision events, the consequence of collisions, or identify receptors to a species level. A complementary technology is therefore required; ideally a second technology that is triggered by an active sonar detection. This would also help reduce data and power demand.

#### 6.1.1 Video

Whilst video cameras will not provide 100% coverage (low level light, water turbidity), they represent an opportunity to capture collisions which is technically robust, whilst also potentially effective for species identification and as such it is the best available option at the current time. Cameras could be included in a system facing the turbine.

#### 6.1.2 Strain Gauge

Strain gauges have been used in a couple of cases and to date it is still unclear as to whether an impact can be detected and extracted from the data of loading on the blade from the turbine operation and water turbulence. Further feasibility work would be required.

#### 6.1.3 Hydrophones

It is worth considering hydrophones on the turbine (as on the Scotrenewables SR250) which could help with collision detection although it would be difficult to automatically integrate this with an off turbine system.

#### 6.1.4 Current profilers

Current profiler are already planned to be used at the site and could be integrated to provide context on species behaviour in particular tidal states.

#### 6.1.5 Development requirements

Key development requirements include:

- Improved and robust active sonar detection, tracking and classification of targets;
- Active sonar species signatures;
- Integrated system with trigger on other technology (camera); and



- Consideration of the system platform, data and power.

Some of these technical issues will be addressed further under the Demonstration Strategy.

## 6.2 Passive acoustics and Pinger tags

Given the uncertainty of whether an active sonar/camera system will be able to identify harbour seals, there are reasons to look at other opportunities.

Tagging a sample of the local population of harbour seals with pingers and having a network of hydrophones would mean monitoring known individuals in the vicinity of the turbines. There is an indication that harbour seals show a level of site fidelity that would make this a feasible option.

A hydrophone array is likely to provide coverage over a greater spatial range (100-300m). The system would need 4 or more hydrophone clusters but with detection capabilities to around 200m, providing significant coverage of the area.

The system would be able to track vocalising cetaceans and tagging individuals could be extended to non-vocalising species. The feasibility of using pinger tags for each sensitive species will be needed to be considered in greater detail, particularly given grey seal and Atlantic salmon behaviour and the limitations identified in section 4.2.

### 6.2.1 Complementary technology

Whilst it may be difficult for a passive acoustic system to detect collisions and determine the consequence of collision, proxy data could be used to infer these e.g. whether a cetacean is still vocalising once it has passed the turbine blades. The system could be part of an integrated system similar to described in section 6.1.

### 6.2.2 Development requirements

Further work is required on:

- The viability of pinger tags for all sensitive receptors;
- Species sample sizes;
- Power and data requirements; and
- Integration into a larger system.

Some of these technical issues will be addressed further under the Demonstration Strategy.

## 6.3 System platform

There was broad agreement at the workshop that the turbines themselves might not provide the best platform for monitoring equipment. A turbine is likely to create a shadow effect on monitoring equipment and any systems that are placed on the outside of the turbine can be considered at risk of damage and faults; recovery of a turbine nacelle to fix these would not be commercially viable.

A system set up in to vicinity of a turbine would provide the greatest coverage however data transfer and power supply become issues. The system could either be on an umbilical cable from the turbine or completely stand-alone. Analysis of the relationship between the monitoring power, system management (data and power), and maintenance and deployment costs should be carried out to find the correct option.

Given the cost of equipment and deployment there must be a consideration of how many turbines can be covered by the monitoring system. With four turbines in the water there are eight areas that need to be covered (with the turbines rotating for the ebb and flood tide). A passive acoustic system should be able to cover these areas, given their detection range; however it is unlikely that it would be possible to cover everything with an active sonar system given the cost of the equipment. A cost benefit

assessment should be undertaken to understand different system combinations and setups and the risks associated with confidence in the data collected.

The Demonstration Strategy does have objectives to cover the logistical and technical requirements of a monitoring system.

#### **6.4 Stranding Scheme**

The SMASS provided a comprehensive proposal on an active and indexed survey effort for marine mammal strandings. Whilst, this provided an excellent overview of the capabilities of stranding studies, there remains the question over whether the survey effort required is proportional to the risk posed by four turbines.

Given that harbour seal populations in the management area have been in decline it needs to be understood whether a broader scheme is more suitable for this, encompassing current industry and the development of the Pentland Firth and Orkney Waters marine energy sites. The SNH proposal (section 3.13) could meet these criteria and the AG recommends working with SNH to further this work.

#### **6.5 Harbour Seal Haul-out Site Monitoring**

There is currently the requirement under legislation to monitor the seal population, which is managed under SCOS. It is unclear at this time as to the exact programme of haul-out site surveys that are carried out under this scheme and how beneficial more focussed monitoring might be to the identifying operational impact from the MeyGen project, given the status of harbour seal populations in the area and the small number of turbines being deployed. The AG proposes that there needs to be greater consideration for the suitability of more focussed scheme.

The AG proposes that monitoring disturbance at harbour seal haul-outs during construction should be considered when there are works in proximity to the identified sites; this will depend on the final construction method.

#### **6.6 Physical Processes Monitoring**

Current profilers will be deployed to monitoring turbine performance and these can be used to verify the physical processes modelling. The current profilers could also be integrated in the other monitoring systems to provide context to receptor behaviour.

#### **6.7 Noise Modelling**

Drifted hydrophone surveys of the Inner Sound once the turbines are installed and operating. Data will verify the EIA model.

## 7. ACTIONS

The Project programme is based on TTG being installed in Q4 2015 - Q1 2016. In order to have monitoring equipment ready and a pre-construction baseline (for some aspects), feasibility and development work will be required.

Many of the actions fall under the scope of the Demonstration Strategy for active and passive sonar.

A summary of all actions is presented in the table below for completeness.

<b>Active Sonar</b>
Testing of active sonar system; species detection and tracking. Development of algorithms to reduce data burden
Classification of targets. Identify and classify species signatures
Feasibility study and testing of integrated camera (with trigger)
Assessment of monitoring platform options. Battery powered unit with data storage or linked to the turbine.
<b>Passive acoustic and pinger tags</b>
Feasibility study for multiple receptors using 3D PAM network
Feasibility study for tagging harbour seal in proximity of MeyGen
Feasibility study for tagging breeding shag and black guillemot in proximity of MeyGen
Feasibility study for pinger tags on MSW Atlantic salmon
Pre-construction deployment of Shag and Black guillemot tags
Pre-construction deployment of harbour seal tags
Pre-construction deployment of Atlantic salmon tags
<b>Stranding Scheme</b>
Feasibility study of PFOW scale stranding scheme
Stranding scheme pre-construction baseline
<b>Construction disturbance harbour seal haul-out surveys</b>
Feasibility study of haul-out surveys
Haul-out pre-construction survey

**APPENDIX C: SCOTTISH GOVERNMENT DEMONSTRATION STRATEGY  
PROJECT FINAL REPORT**

# Scottish Government Demonstration Strategy: Trialling Methods for Tracking the Fine Scale Underwater Movements of Marine Mammals in Areas of Marine Renewable Energy Development

Scottish Marine and Freshwater Science Vol 7 No 14

C Sparling, D Gillespie, G Hastie, J Gordon, J Macaulay, C Malinka, M Wu and B McConnell

© Crown Copyright 2016

**Scottish Government Demonstration Strategy: Trialling Methods for Tracking the Fine Scale Underwater Movements of Marine Mammals in Areas of Marine Renewable Energy Development**

Scottish Marine and Freshwater Science Vol 7 No 14

Carol Sparling, Doug Gillespie, Gordon Hastie, Jonathan Gordon, Jamie Macaulay, Chloe Malinka, Mick Wu and Bernie McConnell

Published by Marine Scotland Science

ISSN: 2043-7722

DOI: 10.7489/1759-1

Marine Scotland Science is the directorate of the Scottish Government responsible for the integrated management of Scotland's seas. Marine Scotland Science (formerly Fisheries Research Services) provides expert scientific and technical advice on marine and fisheries issues. Scottish Marine and Freshwater Science is a series of reports that publishes the results of research and monitoring carried out by Marine Scotland Science. It also publishes results of marine and freshwater scientific work that has been carried out for Marine Scotland under external commission. These reports are not subject to formal external peer-review.

This report presents the results of marine and freshwater scientific work carried out for Marine Scotland under external commission.

### **Crown copyright**

You may use or re-use this information (not including logos) free of charge in any format or medium, under the terms of the Open Government License. See:

[www.nationalarchives.gov.uk/doc/open-government-licence/](http://www.nationalarchives.gov.uk/doc/open-government-licence/)

Scottish Government Demonstration Strategy: Trialling methods for tracking the fine scale underwater movements of marine mammals in areas of marine renewable energy development

Carol Sparling, Doug Gillespie, Gordon Hastie, Jonathan Gordon, Jamie Macaulay, Chloe Malinka, Mick Wu and Bernie McConnell

Sea Mammal Research Unit

Scottish Oceans Institute,

University of St Andrews, St Andrews, Fife, KY16 8LB, UK





## Table of Contents

1.	Executive Summary.....	1
1.1.	Introduction.....	1
1.2.	Sensor Choice and Platform .....	2
1.3.	Field Trials .....	3
1.4.	PAM Results.....	3
1.5.	AAM Results.....	4
1.6.	Discussion – Remaining Work Before Progress to Phase 2.....	5
1.7.	Discussion – General Design Principles .....	5
1.8.	Discussion – Future Considerations .....	5
2.	Introduction .....	7
2.1.	Background and Policy Environment.....	7
2.2.	System Requirements .....	9
2.3.	Project Outputs and Tasks .....	11
3.	Sensor Choice and Platform Review .....	12
3.1.	Sensors: PAM.....	12
3.2.	Sensors: AAM.....	14
3.3.	Sensors: Video Surveillance .....	18
3.3.1.	Nacelle Mounted Video .....	18
3.3.2.	Foundation Mounted Video.....	19
3.4.	Platform Choice .....	19
3.5.	Recommendations for Sensor and Platform Choice .....	23
4.	Overview of Field Trials .....	24
4.1.	June 2015 .....	24
4.2.	August 2015.....	24
4.2.1.	HiCUP Design .....	26
5.	Passive Acoustic Monitoring System Testing and Development .....	28
5.1.	Methods .....	29
5.1.1.	Hydrophone Cluster Design .....	29
5.1.2.	Tag Detection and Tracking.....	30
5.1.3.	Sound of Sleet Deployments .....	31
5.1.4.	Alignment and Calibration Trails .....	32
5.1.5.	Acoustic Data Analysis.....	33
5.2.	Results .....	34
5.2.1.	HiCUP Location .....	36
5.2.2.	Timing Accuracy.....	38
5.2.3.	Localisation Accuracy .....	40
5.2.3.1	Localising the Position of Broadcast Pings .....	40
5.2.4.	Fish Tag Detection Range .....	44
5.3.	Localisation Error Simulation .....	44

5.4.	Data Acquisition and Processing Development .....	48
5.4.1.	Click Timing Measurements .....	48
5.4.2.	Data Acquisition System .....	49
6.	Active Sonar System Testing and Development .....	51
6.1.	3D Marine Mammal Tracking using Multi-beam Sonar .....	51
6.1.1.	Perpendicular Orientation Technique .....	53
6.1.2.	Parallel Orientation Technique .....	56
6.2.	Development of Automated Marine Mammal Classifiers .....	62
6.3.	Porpoise Click Detection with the Active Sonar .....	67
6.4.	VEMCO Acoustic Tag Detection with Active Sonar .....	68
6.5.	Cowling Tests with Active Sonar .....	68
6.6.	Imaging Capabilities of Other Species with Active Sonar .....	69
6.7.	Integrating Tracking Sensors on Seabed Mounted Platforms .....	70
6.7.1.	Sonar HiCUP Deployment A – Imaging Marine Mammals in a Tidal Channel .....	70
6.7.2.	Sonar HiCUP Deployment B – Long Term Functionality .....	77
7.	Video System .....	80
8.	Discussion .....	81
8.1.	Passive Acoustic Monitoring (PAM) .....	81
8.2.	Active Acoustic Monitoring (AAM) .....	82
8.3.	Video Surveillance .....	83
8.4.	Proposed Tidal Turbine Site Deployment – MeyGen .....	83
8.4.1.	PAM .....	84
8.4.1.1.	Installation .....	86
8.4.1.2.	Shore Side Processing .....	86
8.4.1.3.	Data Volume and Management Strategy .....	87
8.4.1.4.	Alarms and SCADA Interface .....	88
8.4.2.	Acoustic Tags .....	88
8.4.3.	AAM .....	89
8.4.3.1.	Shore Side Data Processing, Analysis and Storage .....	91
8.4.4.	Video .....	92
8.5.	Generic Application Principles .....	93
8.6.	Data Analysis Requirements in Relation to Final Deployment .....	94
9.	Literature Cited .....	96
10.	Acknowledgements .....	99
11.	Glossary .....	100
12.	Appendix A: Development of New PAM Timing Algorithms .....	102
13.	Appendix B: Seal Depth Calculation from Vertically Offset Multi-beam Sonars .....	106

# **Executive Summary Scottish Government Demonstration Strategy: Trialling Methods for Tracking the Fine Scale Underwater Movements of Marine Mammals in Areas of Marine Renewable Energy Development**

Carol Sparling, Doug Gillespie, Gordon Hastie, Jonathan Gordon, Jamie Macaulay,  
Chloe Malinka, Mick Wu and Bernie McConnell

## **1. Executive Summary**

### **1.1. Introduction**

Sectoral Marine Planning and related strategic assessment processes have identified a need to evaluate the potential interactions between marine renewable energy developments and marine wildlife as a matter of priority. Despite significant progress in the industry over recent years, there remains a great deal of uncertainty about the risk that tidal turbines in particular pose to marine mammals.

There is, therefore, a clear need to improve the understanding of how animals perceive and respond to devices. The Demonstration Strategy is a key component of the Scottish Government's 'Survey, Deploy and Monitor' (SDM) policy approach to reducing the environmental uncertainty currently inherent in the licensing of renewable energy developments in Scottish waters. It will allow the monitoring of early renewable projects to investigate such interactions. It is crucial that appropriate and achievable techniques are in place for these early projects to collect the data required to characterise the true nature of any impacts – and that data are collected and analysed in such a way as to inform the development of tools that help assess future risk (e.g. collision risk models).

Suitable instrumentation and methodologies are generally lacking and those that are available for the detection and tracking of marine mammals require a degree of development before it is possible to be confident that they can be successfully deployed in conjunction with tidal energy projects. In order to study the fine scale movements of animals close to a tidal energy device and potentially monitor collisions, monitoring systems are required with the ability to track animals with a high spatial and temporal resolution and over a range of several tens of metres from the turbine for a period of several months.

This report details the progress of Phase 1 of the Scottish Government Demonstration Strategy (SGDS) project: Developing and testing methodologies for measuring fine scale marine mammal movements around tidal energy devices.

The approach considered here comprises three sensor systems: Passive Acoustic Monitoring (PAM), Active Acoustic Monitoring (AAM) and Video Surveillance. Whilst each of these systems have been used to study marine animal movements, their combined application in a high tidal energy environment requires development and testing.

## **1.2. Sensor Choice and Platform**

Out of a range of potential platform options reviewed, the recommended approach is to install monitoring equipment which is integrated with the turbine's power and data transfer systems. As it is necessary to have a prolonged period of near continuous monitoring to get sufficient sample sizes and statistical power to make robust inferences from the early demonstration projects, it is recommended that a cabled system would provide the best chance of implementing an optimal monitoring solution capable of meeting the objectives of the project.

After evaluation of the available sensor types, the preferred solutions for this application are the Tritech Gemini multi-beam system for AAM and a multi-hydrophone volumetric array using a networked industrial data acquisition system for the PAM.

In January 2016, a video engineer was commissioned to provide the design for a 180 degree, low light camera with ultraviolet LED bio-fouling control. It is planned that two such cameras will be deployed on the foundation – fore and aft of the turbine. These data will be streamed ashore by cable.

To detect seals with the PAM array it is recommended that VEMCO acoustic pinger tags should be fitted to a sample of local harbour seals (*Phoca vitulina*). The VEMCO V16P-6H acoustic pinger was trialled with successful results. It has a longevity of 100 days with a 1-2 second interval between pulses. Harbour seals should ideally be tagged shortly prior to the deployment of the tidal turbines to provide a period of pre-installation, baseline data. However, the timing of tagging is constrained by the timing of the annual moult, which occurs in August. The pinger transmits at 83 kHz. While the majority of the sound will be above the hearing threshold of harbour seals, it is possible the pulse onset may be perceived. Although

unlikely that prey species will be able to hear them, it is possible that the tags will be audible to some dolphins and porpoises.

### **1.3. Field Trials**

Once the preferred system configuration had been decided, there was a need for a series of development tasks and field tests. Field tests were carried out on the west coast of Scotland in summer 2015 with the following primary objectives.

- a. Test deployment and operation of two domed Tetrahedral Hydrophone Clusters (THCs) on fixed seabed mounted platforms for a period of weeks;
- b. Evaluation of dome shape and hydrophone spacing;
- c. Investigation of detection probability and localisation accuracy of the hydrophone clusters;
- d. Investigation of the ability to detect and track VEMCO acoustic pinger tags (these tags can be fitted to seals so they could be detected and tracked with the PAM);
- e. Test deployment and operation of twin Gemini sonars on a fixed seabed mounted platform for a period of weeks;
- f. Investigation of the imaging capabilities of the sonars from a seabed mounted perspective;
- g. Collection of data to validate the active sonar marine mammal classification algorithms;
- h. Collection of data to develop and validate 3D marine mammal tracking ability using the dual sonar configuration.

### **1.4. PAM Results**

Field trials demonstrated that the THCs were reliable and capable of detecting harbour porpoise (*Phocoena phocoena*) and bottlenose dolphin (*Tursiops truncatus*) clicks. Location accuracy was investigated using trials with an artificial porpoise sound and using simulations. Trials also demonstrated that the spherical cluster design had better timing accuracy than the cylindrical design which is likely to be a result of a combination of the different shape of the cowling and also in the spacing of the hydrophones – the spherical clusters had a narrower hydrophone cluster spacing meaning that the signals were less distorted by echoes than the more widely spaced hydrophones in the cylindrical cluster. Changes in timing accuracy affect the accuracy at which sounds can be localised, but do not affect detection range.

The simulations for a system consisting of three clusters in a triangular configuration around a turbine structure indicate a localisation accuracy of  $< 3$  m; depth  $< 0.7$  m and angle  $< 0.5$  degrees at 25 m from the hydrophones.

While timing accuracy of the VEMCO tag pulses is not as good as it is for porpoise clicks ( $\pm 7.5 \mu\text{s}$ ), this has little impact on localisation accuracy at short ranges.

The PAMGuard software was modified to allow detection of VEMCO acoustic tags. Work has also gone into further developing a data acquisition system in order to make it stable when sharing a network connection with other devices. Further work is required to increase the number of channels from 8 to 12.

## 1.5. AAM Results

This project has developed and tested a technique to track marine mammals in 3D in a tidally energetic environment using two multi-beam sonars. Two different configurations were tested for this and it was concluded that an overlapping parallel horizontal orientation provided the best results. By measuring the ratio of the sonar intensity of a target imaged simultaneously on two sonars arranged in this way, the depth of the animal was calculated. The error in depth estimated in this way is approximately 1.5 m (although this may be less when the sonars are mounted on a static platform).

An efficient algorithm was developed to classify marine mammals in multi-beam sonar data, reducing the high false positive rate reported in previous studies. Cross-validation of the resulting algorithm estimated a cross validation error of 6%. All confirmed seals were correctly classified using the algorithm, while only 8% of non-seal targets were classified as seals. If this result holds with future datasets, the analytical approach will be an effective means of detecting and classifying harbour seals. At present, the effectiveness of these algorithms for classifying other species is unknown; however, it is anticipated that it is likely to be effective for similar sized marine mammals (e.g. grey seals (*Halichoerus grypus*), harbour porpoises, dolphins).

The bottom mounted configuration, likely to be used in the turbine site deployment has also been successfully tested in a tidally energetic environment. This has demonstrated that tracking and detection algorithms can still detect marine mammals against a backdrop of additional background noise and surface clutter (in sea states up to Beaufort 2). However, it should be highlighted that the effects on detection and tracking capabilities of sea states above this are largely unknown at present.

## **1.6. Discussion – Remaining Work Before Progress to Phase 2**

Whilst considerable progress has been made during this project, there remains some development work required before progressing to Phase 2 of the Demonstration Strategy, which is physical deployment at the MeyGen site in association with the Atlantis AR1500 turbine as part of MeyGen's Phase 1a. This includes a series of hardware/installation related decisions and tasks: e.g. final design decisions on THCs, decisions about physical mounting and fixing methods, and agreement on a final design for the AAM seabed platform. Furthermore, there are a number of software developments required, for example to integrate the sonar detection algorithms into the existing sonar software to reduce post hoc analysis.

## **1.7. Discussion – General Design Principles**

While the focus was to develop systems which can be integrated into a specific turbine (AR1500), most of the basic design principles are applicable to the use of these sensors in other situations. The principal areas of investigation and agreement for any monitoring programme associated with a tidal turbine are:

- a. Power and communication availability – both AAM and the PAM systems required several watts of power and produce high volumes of data;
- b. Physical locations for mounting equipment – the preferred position for AAM is at some distance away to ensure full coverage on the rotors whereas an evenly spaced array, close to the turbine is preferred for the PAM. Video is limited by visibility but there is likely to be a trade-off between coverage and range;
- c. Potential for interference or cross talk between different monitoring equipment. For example, Acoustic Doppler Current Profilers (ADCPs) (which are a necessary feature of tidal turbine arrays) and other acoustic monitoring emit high frequency signals which may interfere with the active and passive detectors. Synchronisation can be achieved to reduce interference but these signals could also potentially affect the behaviour of animals around a device.

## **1.8. Discussion – Future Considerations**

Consideration must be given to the analytical techniques that will be required to use the data resulting from this system to parameterise collision risk models. It is likely that data will be sparse due to the expected low encounter rate of local seals and porpoises. It is also likely that data about individual encounters will be fragmented.

It would be useful, therefore, to consider the construction of a Bayesian movement model that could incorporate these three disparate data sets (with uncertainty) to predict a best estimate (with uncertainty) of the 3D trajectory of animals in the vicinity of a turbine blade. This will provide a better ability to make inferences about the behaviour of animals around the turbine, and to determine whether collisions are taking place.

Similarly, there will be a level of uncertainty in how well any of these techniques detect the outcome of an encounter – whether there was successful evasion or a turbine impact. An uninterrupted vocal sequence of clicks continuing after a close encounter with the rotor area would suggest that a porpoise has evaded impact. Similarly if the track data suggests an interrupted movement path after travelling through the rotor sweep this would suggest a lack of impact. Again, there is a need to combine data sets (and perhaps others such as strain gauge information on the turbines) in a Bayesian model to estimate the most likely outcome of a close encounter.



## 2. Introduction

### 2.1. Background and Policy Environment

The Scottish Government has set a target of meeting the equivalent of 100% of Scottish energy demand from renewable energy sources by 2020. The Scottish Government's 2020 Route map for Renewable Energy in Scotland (Scottish Government, 2011, 2012), outlined that offshore and marine energy generation will be an important part of meeting this demand. Scotland's wave and tidal energy resource is almost unparalleled, representing a quarter of Europe's tidal stream and 10% of its wave energy potential. The commercial exploitation of these resources is still at an early stage and learning from prototype and pre-commercial demonstration projects needs to be maximised.

The Scottish Government has a duty to ensure that the industry develops sustainably, with minimal impact on the marine environment. Successive Strategic Environmental Assessments (SEA) for wave and tidal renewable energy generation in Scottish waters (Faber, Maunsell & Metoc, 2007) and those undertaken for the Draft Sectoral Marine Plans for Wave and Tidal Energy (Scottish Government, 2013) identified a need to evaluate the potential interactions between marine renewables and marine wildlife as a matter of priority. Despite significant progress in the industry over recent years, there remains a great deal of uncertainty about the risk that tidal turbines in particular pose to marine mammals. The risk of direct interactions between turbines and marine mammals has been identified in several recent reviews as being a priority issue (Sparling *et al.*, 2013; ORJIP, 2016). In order for the Scottish Government to provide legal consent to future commercial scale tidal projects, there needs to be an understanding of this risk. Currently, the Habitats Regulations Assessments (HRA) and the Habitats Directive require a degree of certainty that a proposed plan or development will not have a significant impact on marine mammal populations before the projects can be consented.

Any uncertainty in terms of risk of impact may lead to lack of future consenting and ultimately curtail the development of the industry. This uncertainty, therefore, translates into increased regulatory constraint and inevitably increased financial cost and investor uncertainty. Such constraints and uncertainties have the potential to limit the development of marine renewable energy solutions, or inhibit the large-scale uptake of the technology at a level that will significantly contribute to meeting future UK energy demand.

To address this, there is a clear need to improve the understanding of how animals perceive and respond to tidal devices. The Scottish Government has put in place a 'Survey, Deploy and Monitor' (SDM) policy which aims to facilitate a risk-based approach for new renewable technology under these uncertainties. In practical terms, this policy will allow the monitoring of early renewable projects to investigate such interactions. It is crucial that appropriate and achievable monitoring techniques are in place for these early projects to collect the data required to characterise the true nature of any impacts – and that data are collected and analysed in such a way as to inform the development of tools to help assess future risk (e.g. collision risk models).

In addition, it is likely that licence conditions (Marine Licences and Section 36 consents under the Electricity Act (1989)) of most early array projects will contain the need for similar monitoring and, therefore, there is much value in developing cost effective ways of achieving this, without putting too onerous a burden on the fledgling tidal industry.

According to the Offshore Renewables Joint Industry Programme (ORJIP) Ocean Energy Forward look document (ORJIP, 2016), collision risk is a priority for the industry and strategic monitoring studies around single turbines and first arrays have the potential to provide evidence to reduce uncertainty around collision risk, evasion and avoidance behaviour. Data are urgently required which will help determine the likelihood/probability of collision and, in particular, close range encounter rates around devices and evidence of evasive abilities.

Furthermore, suitable instrumentation and methodologies are generally lacking and those that are available for the detection and tracking of marine mammals require a degree of development before they can be successfully deployed in conjunction with tidal energy projects (McConnell *et al.*, 2013).

## 2.2. System Requirements

In order to study the fine scale movements of animals close to a tidal energy device, and potentially monitor collisions, monitoring systems are required with the ability to track animals with:

1. High spatial resolution (approximately 1m).
2. Fine temporal resolution (approximately 1s)
3. Over a range of several tens of metres from the turbine.

Since encounter rates are likely to be relatively low (Thompson *et al.*, 2015), the system will need to operate in a stable manner for several months in order to acquire useful amounts of data (multiple encounters with different animals and species) to have the necessary power to make inferences and general conclusions about animal behaviour around tidal turbines and to refine current estimates of collision risk.

There are two principal elements that data are required to inform. The first is the empirical near field encounter rate close to operating devices and the second is the measurement of marine mammals' ability to avoid turbines.

Encounter rates can be compared to the predicted encounter or collision rate estimates carried out during the licencing of the project. Encounter rate modelling carried out for the MeyGen project predicted between 6.5 and 7.8 harbour seal 'encounters' per turbine per year depending on the density estimate used (SRSL, 2012). An encounter was defined as the rate of encounters between an animal and the volume of the swept area of the rotors. Equivalent predictions for harbour porpoises were between 4.9 and 9.4 depending on whether a mean estimate or upper confidence limit of the density estimate was used. These numbers are low but scaling them up to the volume covered by the monitoring system could potentially allow the determination of how many detections to expect. The encounter rate can then be monitored on a regular basis to assess how empirical rates compare to those predicted.

However, an on-going re-assessment of collision risk for the project provided estimated collision rates of between 13 and 389 per turbine per year for harbour seals depending on which available mean density estimate was adopted (Band *et al.* in review), and if the wide confidence intervals around these density estimates are considered, the potential range is even greater. It is clear that there is some uncertainty regarding the likely encounter rates and it will be important to regularly review detection rates and update predictions of risk accordingly.

The ability to measure avoidance or evasion behaviour will depend entirely on the encounter rate and as noted above, there is uncertainty about what this might be at the site. Therefore, it is difficult to define an exact required monitoring period, however, it is likely that an extended monitoring period of at least twelve months will be required.

The primary target species around Scotland in areas of tidal energy resource are harbour porpoises and harbour seals. Together these are the species of most concern due to the high potential for encounter for harbour porpoises (Wilson *et al.*, 2007) and the current unfavourable status of the Scottish harbour seal population (SCOS, 2015). These target species are also representative of the two primary 'types' i.e. an echo-locating cetacean species that can be detected acoustically and a seal species which do not echolocate and can only be detected by active or visual means.

The approach considered here comprises three sensor systems: Passive Acoustic Monitoring (PAM), Active Acoustic Monitoring (AAM) and Video Surveillance. Whilst each of these systems have been used to study marine animal movements, their combined application in a high tidal energy environment requires development and testing.

This report details the progress of Phase 1 of the Scottish Government Demonstration Strategy (SGDS) project: Developing and testing methodologies for measuring fine scale marine mammal movements around tidal energy devices.

To achieve its objectives, the project was split into a number of distinct tasks:

- Sensor and platform choice;
- Identification of development work required to provide a system to meet these requirements;
- Hardware and software development work;
- Field tests;
- Scoping and planning for Phase 2 of the project – the deployment of the system at a tidal energy development.

### **2.3. Project Outputs and Tasks**

The deliverables from Phase 1 of the SGDS project are as follows:

1. Further development of suitable active and passive sonar systems for deployment in a high tidal energy site. This should involve some initial experimental field trials to test the capabilities of the systems in a high tidal energy environment, resulting in,
2. A technical specification for an AAM, PAM and video monitoring system that has the capacity to track marine mammals around tidal turbines including both hardware and software, and including consideration of positioning and mounting.

The remainder of this report is split into a number of sections.

Section 3 is a review of the available sensor systems and options for deployment platforms (e.g. autonomous battery powered system or cabled to shore). The section concludes with the recommendations for PAM, AAM and video surveillance systems and configurations, as well as the preferred option for deployment platform.

The subsequent sections (Sections 4 to 7) detail the development and testing work that was undertaken for each sensor type. These all follow a similar format where the development objectives are described, followed by accounts of the work carried out to meet those objectives, both in the laboratory and in the field, and both in terms of hardware and software development. Since the location and methodology of the AAM and PAM field trials overlapped, an overview of the field trials is provided in a separate section to avoid repetition.

Section 8 provides a discussion and an overview of the development work still remaining before the deployment of the sensors integrated with a tidal turbine can take place in addition to providing an overview of the general principles to be considered for the implementation of this type of monitoring on other projects.

### 3. Sensor Choice and Platform Review

At the outset of this project, it was identified that there were a number of available options for sensor choice/configuration and deployment platform. A review of these options was carried out as the first task in this project. A separate report was completed which described the available options for both sensor choice and deployment options, detailed the evaluation process and provided recommendations for progression (McConnell *et al.*, 2013).

#### 3.1. Sensors: PAM

Both echolocation clicks and whistles can be localised by measuring the time of arrival differences of the sounds on multiple hydrophones. A closely spaced cluster of four hydrophones arranged in a tetrahedral pattern can measure bearings to a sound source, but will not provide any range information. However, if the hydrophones are spaced further apart they can, in principle, track animals in three dimensions. In practice more than four hydrophones are required for accurate tracking, with tracking accuracy falling off rapidly beyond the array boundaries. As a rule of thumb, reasonable accuracy can be obtained out to about three times the array dimension, with very poor accuracy beyond ten times the array dimension. Operation of volumetric arrays does of course require the sounds to be detected on multiple hydrophones and the different sounds on the different hydrophones to be accurately matched. This can be problematic due to the highly directional nature of echolocation clicks which effectively makes it impossible for an animal such as a porpoise to be pointing towards multiple widely spaced hydrophones at the same time. Previous research has shown, however, that animals can successfully be detected on multiple hydrophones tens of metres apart (Macaulay *et al.*, 2015).

Harbour porpoise vocalise at a frequency of around 130 kHz, which requires specialist ultrasonic sampling equipment, typically sampling each hydrophone on the system at a rate of at least 500 kHz. Uncompressed 16 bit data from a single hydrophone, therefore, requires 86 GBs of storage per day. A four channel system would, therefore, require 345 GBs and an eight channel system nearly 0.7 TBs of storage per day. While there are an increasing number of commercially available autonomous recorders on the market (Sousa-Lima *et al.*, 2013) none of these are capable of multi-channel high frequency recording and, even if they were, they are unable to store the data for more than a day or two.

For this application a Commercial DAQ Chassis based system was selected – with up to ten hydrophones connected via custom built preamplifiers to a National

Instruments chassis (e.g. NI cDAQ-9188 or cRio 9067). Simultaneous sampling occurs across all channels making it ideal for accurate timing measurement. The system can be installed as either stand-alone, or connected via high speed Ethernet to shore. When connected to shore, processing takes place in real time on a standard PC, which can detect and localise both clicks and whistles in near real time and also archive either all, or a selection of, the raw audio data for later analysis.

Power consumption of the system (including the NI chassis and associated preamplifiers) is approximately 10W. A 100Ah battery would, therefore, run the system for five days. One of the FLOWBEC (Williamson *et al.*, 2015) battery banks with an 1100Ah capacity could potentially run the system for 50 days.

When running stand-alone on an autonomous platform, the duration of deployments is limited primarily by data storage capacity. With lossless data compression (Johnson, Partan, and Hurst, 2013) a four TB hard drive would provide storage for 20 days of data for an eight channel hydrophone system. When connected via Ethernet cable to shore, deployment duration is unlimited. However, a reasonably high bandwidth (minimum 100 Mbps) Ethernet connection is required.

The cabled system can process data from up to ten independent hydrophones simultaneously and has the great advantage of providing high resolution real time data to operators on shore. Power is supplied from shore and is, therefore, unlimited as is storage since hard drives can easily be swapped by on shore operators. The system is reliant on the availability of a shore cable providing power and high speed fibre capable of delivering a data rate of 100Mbps, though this is not a problem using standard fibre LAN components if a dedicated fibre can be made available for PAM data only. Shore side processing is accomplished using the PAMGuard software (Gillespie *et al.*, 2008; [www.PAMGuard.org](http://www.PAMGuard.org)) which is fully open source.

This system has been installed in a 'cabled to shore' format on the Tidal Energy Ltd (TEL) turbine recently deployed in Ramsey Sound. The stand-alone system has been developed under a Natural Environment Research Council (NERC) Knowledge Exchange grant and trials of a free floating system, in which the data acquisition chassis was housed in a floating barrel with an eight hydrophone tracking array suspended beneath it, were recently successfully completed in Kyle Rhea Scotland and the West Anglesey Demonstration zone in Wales (Macaulay *et al.*, 2015).

Whether operating in stand-alone or cabled mode, data processing is conducted using the PAMGuard software which can search simultaneously for both clicks and whistles. A modern PC is capable of searching each data channel individually for

sounds of interest, so hydrophones can be installed in almost any configuration. Three dimensional localisation is available for clicks which will be implemented for whistles in the future.

### **3.2. Sensors: AAM**

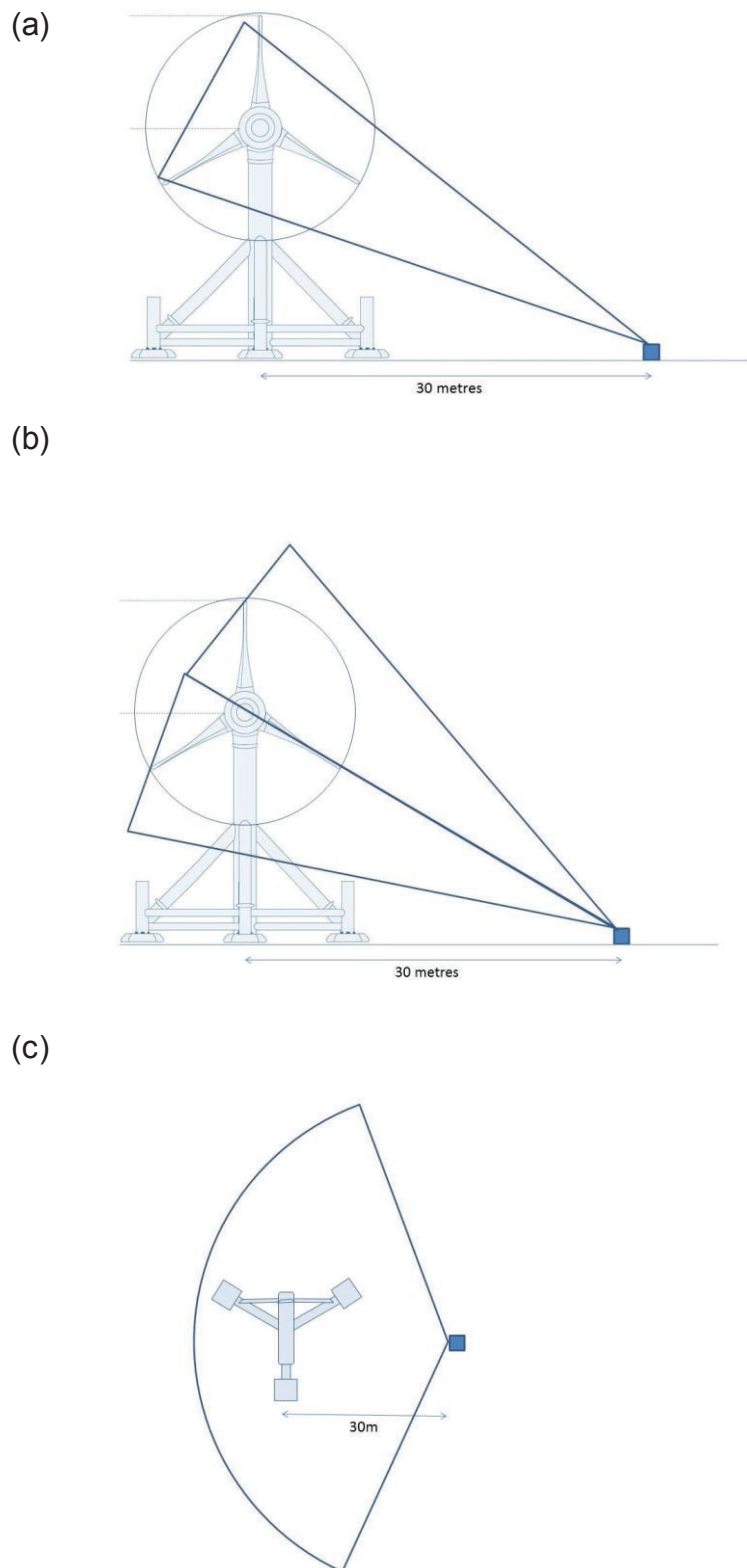
Previous work through a Department of Energy and Climate Change (DECC) funded project reviewed a wide range of active sonar systems, critically testing and validating a selection of systems that could potentially be used as marine mammal tracking systems for the tidal stream energy industry (Hastie, 2012). The results suggest that one system (Tritech Gemini) has the potential to reliably detect and track small marine mammals around tidal stream energy devices at relatively high resolution without causing overt behavioural responses by animals. The Gemini has proved to be effective at detecting marine mammal species including grey and harbour seals, harbour porpoises, and bottlenose dolphins. To date, this remains the only system that has been fully validated with marine mammals and has been shown not to cause overt behavioural responses by marine mammals (Hastie, 2012). Although there are clearly a number of other sonar systems capable of detecting marine mammals (with other devices, such as the Imagenex multi-beam used in the FLOWBEC system, showing promise for the detection of marine mammal targets in tidally energetic environments (Williamson, 2015)), at this stage it would be relatively high risk for the project to consider using these prior to further detection capability and behavioural response tests; it is therefore recommended that the Tritech Gemini be used for this application.

Previous work testing the detection capabilities of the Gemini (Hastie, 2012) was carried out in low energy tidal areas and the imaging capabilities of this system in tidally energetic areas was not validated. The use of multi-beam sonar in tidal environments can be limited by inherent problems associated with acoustics in these conditions; it is known that the highly heterogeneous water characteristics near the surface or wind generated clutter are likely to have significant impacts on the imaging capabilities of sonar. It is possible that animals will be effectively masked by acoustic clutter under certain conditions, therefore, some testing is required in a seabed mounted configuration (see Section 6.7.1).

The temporal resolution of the Gemini is approximately 10Hz when imaging up to ranges of 60 metres; the angular range resolution is 0.5° and the range resolution is 0.8 cm. The horizontal and vertical swathe widths of the Gemini are 120° and 20° respectively. Effective automated detection ranges measured in previous work were ~36 metres (Hastie, 2012). It would, therefore, seem most efficient to mount the



sonar at a location approximately 30-36 metres from the rotors. Given this, the most efficient option for monitoring the rotors would be a remote platform located at this distance from the side of the turbine.



**Figure 1:** Potential deployment configurations of multi-beam active sonar deployed on a remote platform to the side of an 18 m diameter rotor turbine. The figure illustrates the approximate rotor coverage using (a) single, and (b) dual sonar heads, and (c) shows a plan view of the approximate horizontal coverage. These configurations are based on the dimensions of the proposed devices for the MeyGen site.

Given the vertical swathe of the multi-beam is 20°, the effective vertical coverage of the rotors at a range of 30 metres from the turbine would be ~11 metres; this clearly limits the monitoring capabilities for turbines with larger rotors. However, full rotor coverage for larger turbines could be achieved using two sonar heads on a remote platform (Figure 1), although this would need more power.

Based on these general monitoring approaches, two systems are described (each with one or two sonar head configurations) which could be used for long term sonar monitoring:

### **System 1: Multi-Beam Sonar with Fibre Cable to Turbine/Shore**

As described above, the most efficient location for a sonar monitoring platform would be located ~30 metres to the side of the turbine with a single or dual (depending on rotor diameter) multi-beam sonar orientated to cover the rotors.

Power (24V) for the platform would be supplied via an umbilical from the turbine. As raw data can effectively be streamed ashore using the same umbilical, no on board detection or tracking processing would take place and all raw sonar data transfer would be direct via a high speed optical fibre to a PC onshore; processing and data storage would also take place onshore. The system is reliant on the availability of an umbilical providing suitable power and high speed fibre capable of delivering a data rate of a minimum of 100 Mbps; in practice data rates are markedly lower than this but it is not anticipated that using standard fibre LAN components would be problematic.

The platform for the sonar mounting could be a relatively small structure (similar to an ADCP mount) but would require appropriate ballast for the tidal conditions.

### **System 2: Multi-Beam Sonar on Autonomous Platform (e.g. FLOWBEC)**

In an autonomous configuration, power for the platform would be supplied from a bank of batteries on the platform. This is the approach taken by the FLOWBEC platform which has a total of ~4,400Ah of battery capacity at 12V on it. Seventy five percent of this (assuming 25% used to power an accompanying PAM system), under full discharge would potentially provide power for a single or dual sonar system for a total of 38 and 21 days respectively. If anything less than full battery discharge was required (e.g. to prolong battery life) then these times would reduce accordingly.

As raw sonar data cannot be streamed to shore in this configuration with a battery powered platform such FLOWBEC, on board detection or tracking processing would have to take place on an integrated low power PC with data storage on an external 4TB HDD. Based on storing all raw data, this approach would allow a total of 36 and 18 days monitoring for a single and dual sonar system respectively. Alternatively, by running the on-board detection algorithms and only saving data associated with target detections, the storage requirement could be markedly reduced. For example, based on a detection of three targets per hour, a total of 164 and 82 days monitoring would be possible for the single and dual sonar systems respectively (although power would become limiting before this).

### **3.3. Sensors: Video Surveillance**

Video surveillance can be used to detect a subset of any animal encounters, although it is restricted to periods of good visibility. Video during such windows of daylight and good visibility may determine and characterise those PAM and AAM track segments that could potentially have resulted in a collision. Thus video will be continuously streamed (estimate of 16 Mbps per camera) ashore and archived on hard drive. These data will be inspected when there is indication from the PAM or AAM systems that there has been likely animal encounter. It is also proposed, however, that random segments (say one hour duration each day) should be inspected to ensure that there are no video-detected animal encounters that were not detected by PAM and/or AAM.

It is acknowledged that video surveillance and thus the ability to interpret the outcome of animal encounters is not available at night or in poor underwater visibility.

The siting and design of any video surveillance system depends on the turbine and foundation design. Here, two system configurations for a specific turbine (Atlantis AR1500 with bespoke foundation – planned for deployment in 2016 by MeyGen) are considered:

#### **3.3.1. Nacelle Mounted Video**

MeyGen have specified that there will be a single camera mounted on the nacelle (casing) whose primary purpose is to provide visual information on turbine operation. Its field and direction of view can be adjusted shore side by a remotely controlled zoom, pan and tilt mechanism. It will be fitted with a mechanical scrubber to remove

any optical port bio-fouling. However, at any one time it will be only able to view a small part of the rotors (less than one third of total arc of rotation). Therefore, the nacelle mounted video is not ideal for the monitoring requirements of this project.

### 3.3.2. Foundation Mounted Video

The preferred option is to mount a total of two wide-angle video cameras on two of the foundation legs. They would be positioned just inboard of the hydrophone clusters – and would share the cabling conduit to the dry junction box on the foundation tower. Being wide-angle, these video cameras will capture more than the turbine arc, enabling near misses to be positively detected where visibility allows.

## 3.4. Platform Choice

The practical difficulties of installing complex monitoring systems in a highly energetic marine environment should not be underestimated and while attempts were made to separate out the “Sensors” from the “Platforms” it was not possible to finalise one without consideration of the other. AAM, PAM and video all generate considerable quantities of data (many GBs per day) which must either be stored or processed on the device or transmitted to shore, and they all require power.

The power required to operate the sensors and the storage required for the data they generate restrict the lifetime of autonomous battery powered platforms. On the other hand, the infrastructure costs for cabling these devices to shore are not insignificant. Thus there is not a “one size fits all” monitoring solution, but a number of options for both the platform/installation method and for the sensor technology to choose from for a particular application.

In order to inform the evaluation of the available deployment options, a number of key drivers were identified in discussion with the project steering group. These are outlined in Table 1.

**Table 1**  
Key drivers used to evaluate deployment options.

<b>Driver</b>	<b>Description</b>
<b>Data latency</b>	The time between data collection and having the data 'in hand' to examine. How 'real time' is the monitoring?
<b>Suitability for preferred sensors</b>	Can the power and data requirements of selected sensor (PAM and AAM and video) technology be met using the proposed deployment option?
<b>Ability to alter monitoring settings</b>	Can the user communicate with the sensors <i>in situ</i> to change settings if required?
<b>Duration of deployment</b>	How long can individual monitoring periods be before power availability or data storage limits continuing data collection?
<b>Generality</b>	How easily the technology or design can be applied to a range of sites and tidal turbine technologies.
<b>Scalability</b>	How easily the technology can be scaled up to monitor an array of turbines over extended time scales.
<b>Technology readiness/availability</b>	Is the deployment option already available 'off the shelf'? If not, what development work is required? What other resources are required?
<b>Lack of impact</b>	Is the methodology proven not to influence the behaviour of marine mammals?
<b>Availability for use in this project</b>	If already developed, is the option available for use in the current timelines of the project?
<b>Cost - Development</b>	What is the cost involved in developing the deployment option to meet the requirements of this project?
<b>Cost – Running</b>	What are the costs involved in ongoing monitoring using a particular deployment option?
<b>Risks/Intervention requirements</b>	What are the risks involved in the particular deployment option? How easily can they be mitigated? What requirements are there to access underwater components using divers/ROVs etc.?
<b>Redundancy</b>	What happens when things go wrong? How much redundancy can be built into the system to mitigate against technical problems?

A number of deployment options were identified and reviewed based on these criteria. From this review, two main options were identified:

1. To cable the sensors to shore via the turbine with power and data transfer abilities supplied by the turbine infrastructure, or
2. To deploy on an autonomous, battery-powered system.

Table 2 provides a summary of the evaluation of these two options against the drivers identified above while Table 3 provides a summary of the advantages and disadvantages of each system.

**Table 2**

Evaluation of each deployment option against the key drivers.

<b>Driver</b>	<b>PAM and AAM on turbine or remote structure(s) - power &amp; comms. via cable from turbine</b>	<b>Using a self-contained, autonomous platform such as FLOWBEC as remote structure for PAM and AAM- battery power and on board data storage</b>
Data latency	Low	High
Suitability for preferred sensors	High	Medium – suboptimal spacing for PAM clusters
Ability to alter monitoring settings	High	Low
Duration of deployment	Not limited by power or comms	Short (~20 days - PAM data storage limits duration)
Generality	Medium	High
Scalability	Medium	Medium
Technology readiness/availability	Medium	High
Availability for use in this project	Dependent on turbine manufacturers and operators	Dependent on FLOWBEC frame availability
Cost - Development	~£20K	~£10K
Running cost of 1 year of deployment	~£45K	18x 20d deployments = ~£340K (from previous deployments at EMEC)
Risks/intervention requirements	Risks associated with cable connection. Requirement for ROV or diver for electrical connection to turbine. Potential risk to turbine from umbilical. Complexity of connections and integration	Deployed and retrieved from boat. ROV required for retrieval. Little risk to turbine. Additional H&S risk of multiple boat operations.
Redundancy and maintenance	Can build in redundancy and system can be accessed remotely to troubleshoot, although heavy reliance on cable and connectors – difficult to access / replace hardware	Little redundancy possible on single deployment. System has to be recovered to alter settings. But regularly maintained so there is opportunity to replace or repair hardware between deployments.

**Table 3**

Summary of the main advantages and disadvantages of the two main deployment options.

Option	Advantages	Disadvantages
<b>PAM and AAM integrated with turbine (either on remote structure or on turbine structure itself but power &amp; comms via cable from turbine)</b>	<ul style="list-style-type: none"> <li>• Extended, continuous deployment</li> <li>• Risk of data loss low</li> <li>• Real time data inspection (reduced risk of data loss and ability to 'tweak' settings)</li> <li>• Can trigger video data collection</li> <li>• Smaller seabed deployment footprint possible</li> </ul>	<ul style="list-style-type: none"> <li>• Expense of cable system</li> <li>• Difficulty/cost of connection</li> <li>• Failure of umbilical would result in loss of monitoring</li> <li>• H&amp;S implications of underwater connections – ROVs or divers</li> <li>• Dependent on cooperation (and funding) with turbine manufacturers/operators</li> <li>• Not field tested</li> <li>• Cannot collect baseline data</li> </ul>
<b>Using FLOWBEC as remote structure for PAM and AAM- battery power and on board data storage</b>	<ul style="list-style-type: none"> <li>• Can be deployed anywhere</li> <li>• Independent of turbine design</li> <li>• Field tested and reliable</li> <li>• Baseline data collection possible</li> <li>• Deployment and retrieval relatively low risk to turbine</li> <li>• Repairs/replacements possible between deployments</li> </ul>	<ul style="list-style-type: none"> <li>• Only short deployments possible – system power and data limited</li> <li>• High cost of multiple deployments</li> <li>• Cannot check data/tweak settings during deployment so if there is a problem, data will be lost</li> <li>• Cannot trigger other monitoring systems in real time</li> <li>• Requirement for adaptation of existing platform to accommodate PAM array and integrate with existing sensors</li> <li>• Dependent on availability of FLOWBEC</li> </ul>



### **3.5. Recommendations for Sensor and Platform Choice**

After evaluation of the available sensor types, the preferred solutions for this application are the Gemini Tritech multi-beam system for the AAM and a multi hydrophone volumetric array based on the NI-chassis type system for the PAM. Although the choice of preferred sensor types are somewhat independent of the deployment platforms under consideration, it is impossible to finalise one without consideration of the other. While both the preferred PAM and AAM sensor systems can run on autonomous platforms using battery power and local data storage, the deployment duration will be limited. If the preferred PAM system is deployed then duration is ultimately limited by the data storage capabilities (20 days with 4TB on-board storage). A single multi-beam would run for approximately 38 days using three quarters of the battery power capacity available on the FLOWBEC frame (assuming three banks used to power the multi-beam and one bank to power the PAM), however, as two multi-beam units would be required to image turbine rotors of 18 m diameter, this would reduce deployment period to 21 days.

Due to the likely relatively low encounter rate of marine mammals with turbines, and the need for a prolonged period of near continuous monitoring to get sufficient sample sizes and statistical power to make robust inferences from the early demonstration projects, it is recommended that a cabled system would provide the best chance of implementing an optimal monitoring solution capable of meeting the project objectives. Early discussions with turbine engineers suggested that this was a practical option and the development and maintenance costs involved are below those estimated for regular retrieval and deployment visits for an autonomous platform.

The outcome of this review was discussed by the Project Steering Group at a meeting in September 2014, and based on input from MeyGen confirming that the sensor systems could be cabled and interfaced with the AR1500 turbine and that the alternative turbine design (Andritz Hydro Hammerfest) lacked suitable power and data communications bandwidth, the decision was made to develop an integrated cabled monitoring solution with the AR 1500 Atlantis turbine.

## **4. Overview of Field Trials**

There were two separate sets of field trials carried out as part of the development programme to meet the objectives listed in the subsequent sections. These were carried out in June and August 2015 on the west coast of Scotland in the Kyle of Lochalsh/Kyle Rhea and the Sound of Sleat area. Further details of each of these field trials are provided below.

### **4.1. June 2015**

Trials of the PAM and AAM systems under development were conducted in waters between the Isle of Skye and the mainland, between 7 and 12 June 2015. The trials had the following aims:

- a) Conduct preliminary tests of PAM system performance;
- b) Assess the ability of a dual AAM system to measure the depth of seals from the relative acoustic intensities on different AAM systems;
- c) Conduct a fine scale site survey of possible mooring sites in the upper Sound of Sleat in preparation for more extensive trials of both the PAM and AAM systems in August 2015.

### **4.2. August 2015**

The August field trials involved deploying bottom mounted frames holding monitoring equipment at two sites in the Sound of Sleat (#1 on Figure 2) and Kyle Rhea (#2 on Figure 2). The exact locations of the deployments are given in Table 4. The trials had the following aims:

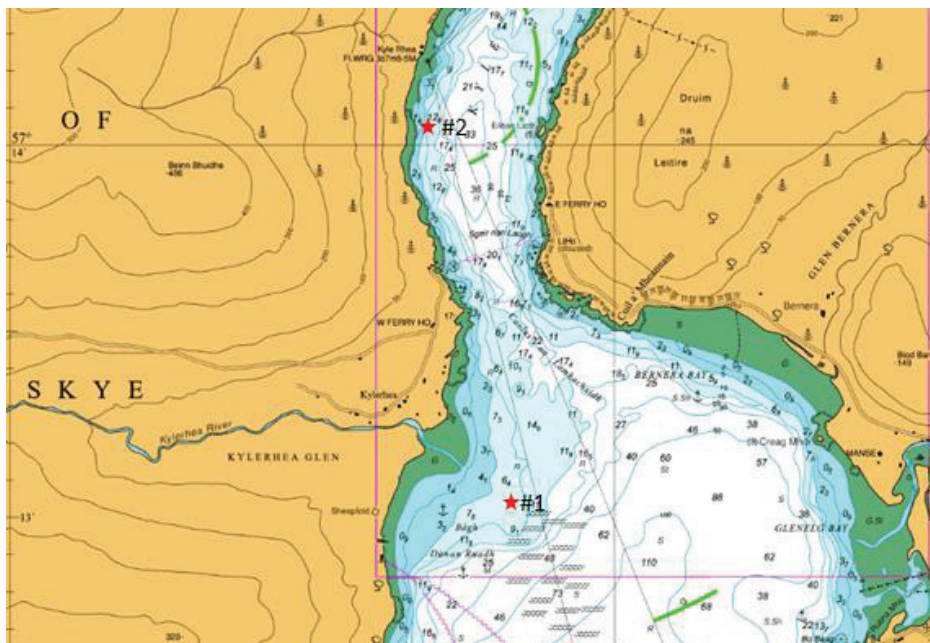
AAM:

- a) Test deployment and operation of twin Gemini sonars on a fixed seabed mounted platform for a period of weeks;
- b) Investigation of the imaging capabilities of the sonars from a seabed mounted perspective (evaluate effects of surface turbulence/wave action on the sonar data);
- c) Collection of data to validate the marine mammal classification algorithms (sonar data in combination with visual observations of marine mammals);
- d) Collection of data to validate 3D marine mammal tracking (seal carcass towed through the sonar beams);

- e) Investigate biological growth on the sonar transducers over a longer period of deployment;
- f) Deploy an EK60 echo sounder to evaluate potential cross talk between the sonars (this is because of plans to deploy an EK60 as part of the extended monitoring at the MeyGen site)

PAM:

- a) Test deployment and operation of two domed hydrophone clusters on fixed seabed mounted platforms for a period of weeks;
- b) Investigation of detection probability and localisation accuracy of the hydrophone clusters;
- c) Investigation of the ability to detect and track VEMCO acoustic pinger tags (these tags could be fitted to seals so they could be detected and tracked with the PAM);
- d) Deploy an EK60 to evaluate potential interference with PAM monitoring and understand the potential for the EK60 signal to influence the behaviour of marine mammals;
- e) Evaluation of dome shape and hydrophone spacing.



**Figure 2:** Chart of the Sound of Sleat (#1) and Kyle Rhea (#2) with the mooring and deployment positions indicated.

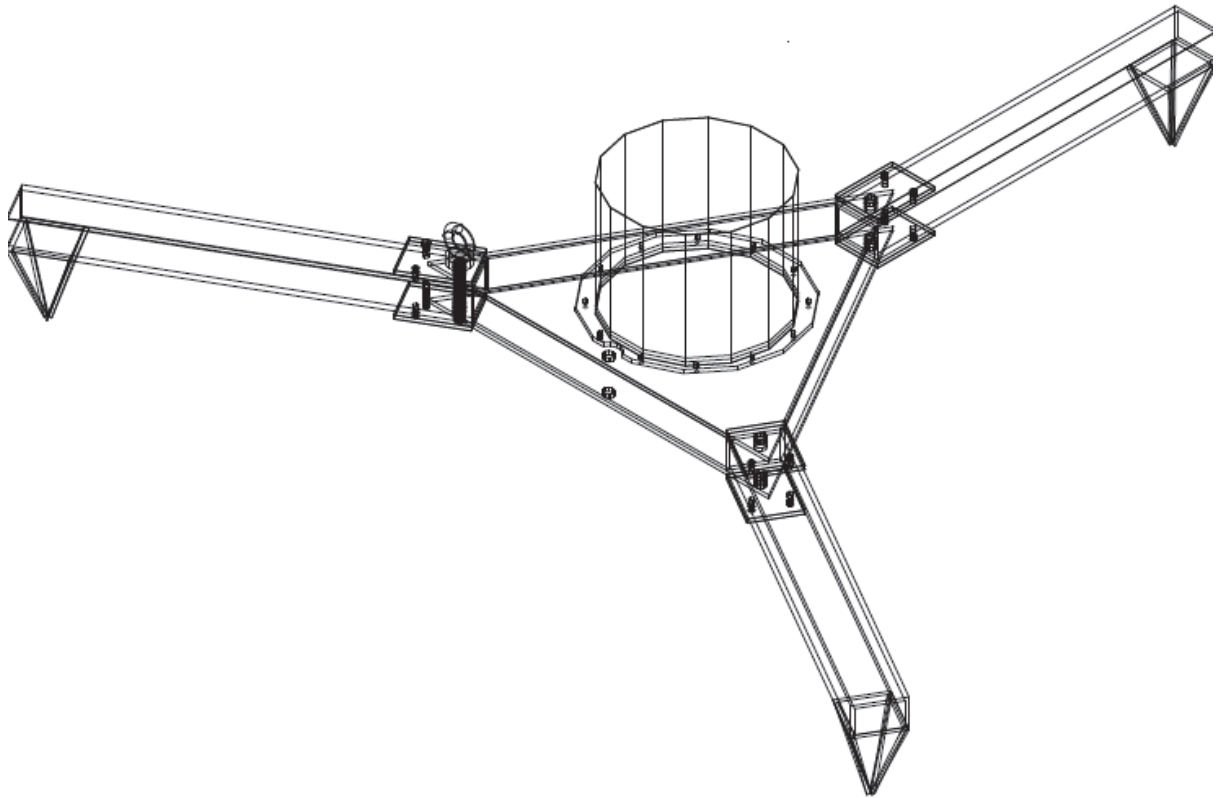
**Table 4**

Deployment locations of the three High Current Underwater Platform (HiCUPs).

HiCUP Unit	Longitude	Latitude
Active sonar HiCUP	5°39.606'W	57°13.019'N
Passive sonar cylindrical-top HiCUP (hydrophone channels. 0, 1, 2, 3)	5°39.631'W	57°13.010'N
Passive sonar spherical-top HiCUP (hydrophone channels. 4, 5, 6, 7)	5°39.603'W	57°13.039'N

#### 4.2.1. HiCUP Design

A High Current Underwater Platform (HiCUP) for housing the monitoring equipment was designed and built for these trials. The requirement was for a structure which could be placed on, and retrieved from, the sea bed by a relatively small non-specialist, locally available vessel, would be stable on uneven terrain and would not move in tidal currents of up to six knots. Additional considerations were that it should be possible to break the structure down so that it could be transported on a standard Euro-pallet. The dimensions (0.5 m high and 1.8 m from centre to end of each leg), shape and design were based on calculations of turning moments and stability for a structure in a high tidal current. These dictated a structure which was heavy, had as low a profile as possible, a broad base and three points of contact (Figure 3). Each HiCUP was fabricated in steel with 400 kg of lead ballast, and each had an overall weight of 1000 kg. Three of these platforms were constructed, one for the deployment of the dual Gemini sonars and two for the deployment of two hydrophone clusters. The PAM (Section 5) and AAM (Section 6) sections below provide more detail on the HiCUP equipment deployments in August 2015. Figures 4 and 5 show the platforms being deployed and the vessel used for deployment.



**Figure 3:** Design of Hi Current Underwater Platform (HiCUP).



**Figure 4:** Hi Current Underwater Platform (HiCUP) with dual sonar configuration being deployed in Kyle Rhea.



**Figure 5:** Research vessel in the north-western part of the Sound of Sleat, cabled to underwater passive and active acoustic HiCUP clusters, in August 2015.

## **5. Passive Acoustic Monitoring System Testing and Development**

Previous work showed that arrays of multiple hydrophones are capable of localising and tracking echo-locating harbour porpoises. In particular, this work showed that in spite of the narrow beam of sound produced by this species, clicks were detected on hydrophones sufficiently far apart for accurate 3D localisation (Macaulay *et al.*, 2015). The study used drifting vertical arrays consisting of a small tetrahedral structure close to the surface with an additional four or eight hydrophones hanging in a vertical line. For a given number of hydrophones optimal localisation will, in principle, be achieved with the hydrophones spread out individually about the volume of interest. In real working conditions, each individual deployed hydrophone carries with it cabling and mounting infrastructure costs as well as the requirement of knowing exactly how each hydrophone is positioned. Furthermore, it may be difficult to match clicks on widely spaced hydrophones, particularly when time of arrival differences between different hydrophones approach typical inter-click intervals for the species under study. The approach of mounting hydrophones in clusters of four in a tetrahedral geometry was therefore adopted. Each Tetrahedral Hydrophone Cluster (THC) can estimate unambiguous bearings to detected sounds, but provides no range information. When data from two or more THC's are combined, three dimensional tracking is possible. Each THC has dimensions in the range 30-50 cm,

meaning that they can be constructed and mounted as single units, thereby reducing cabling and siting complexity and cost.

## 5.1. Methods

### 5.1.1. Hydrophone Cluster Design

Hydrophones within each THC need to be rigidly supported, but using a minimum of material so as not to cause reflections and distortions in the sound paths between each hydrophone, reducing the accuracy of timing measurements. At the same time, each cluster needs to be physically strong in order to survive the high energy environment around a tidal turbine and collisions with matter (seaweed, debris, etc.) moving in the tidal flow. To satisfy the conflicting needs of a light structure and a strong structure, THCs were mounted on a light frame, housed within a physically strong, but acoustically transparent cowling. High density polyethylene was identified as a material having an acoustic impedance close to that of seawater. This is a material which is physically robust and easy to weld. It is widely used for construction in the fish farm industry and is also used for the hulls of small working vessels.

**Table 5**  
Hydrophone cluster specifications.

	Cylindrical Cluster	Spherical Cluster
Hydrophone Spacing	30 cm	15 cm
Hydrophone element	6 mm cylinders	12.5 mm spheres
Cowling Shape	Flat topped cylinder	Domed
Distance hydrophone to wall (time for sound to travel that distance)	7.7 cm (102µs)	16.3 cm (218µs)

Two THCs were constructed, one with a 30 cm spacing between hydrophones, the other with a 15 cm spacing. The 30 cm spaced hydrophones were made from 6 mm cylindrical ceramics, the 15 cm spaced ones from 12.5 mm spheres. These were housed under two differently shaped cowlings, the first having a flat top and the other a more domed shape (Table 5). Flanges were welded to the two cowlings so that they could be securely bolted to a plywood base supporting the hydrophone mounts (Figure 6).



**Figure 6:** Polyethylene cowlings, on a plywood base, used to protect the two hydrophone clusters.

In order to demonstrate that this arrangement of multiple hydrophone clusters around a turbine would provide the required detection and localisation range and accuracy for monitoring the fine scale behaviour of echo-locating cetaceans around a tidal turbine, a number of developments and experimental trials were required:

- Testing of the THCs on fixed seabed mounted platforms in an area of tidal current for a period of weeks;
- Investigation of detection probability and localisation accuracy of the hydrophone clusters;
- Evaluation of cluster cowling shape and hydrophone spacing;
- Investigation of the potential for interference from the Tritech Gemini sonars;
- Development of data acquisition system to allow stable recording of 12 channels of data simultaneously.

#### 5.1.2. Tag Detection and Tracking

In addition to the primary task of detecting and tracking small cetacean species, the possibility of using the PAM system to track tagged seals was investigated. Neither harbour nor grey seals regularly vocalise, therefore, it was suggested that if a number of local seals were to be fitted with acoustic pinger tags, any interaction with the turbine could be detected by the PAM system. Acoustic pinger tags are mainly used in fish studies and the commercial availability of such fish tags was reviewed. For this study the tags should:

1. Transmit frequently (interval  $\leq 1s$ ) to provide sufficient temporal resolution;
2. Last at least three months;
3. Be detectable by bespoke PAMGuard algorithms;
4. Be individually identifiable;
5. Be capable of being tracked by the PAMGuard system;
6. Interfere minimally with seal behaviour.



The preferred pinger tag was the VEMCO V16P-6H continuous transmitter (<http://VEMCO.com/wp-content/uploads/2014/05/v16-cont.pdf>) which transmits at a frequency of 83 kHz every 1-2 s (depending on depth) and has a longevity of approximately 100 days (see Figure 7).



**Figure 7:** VEMCO V16P-6H continuous transmitter tag.

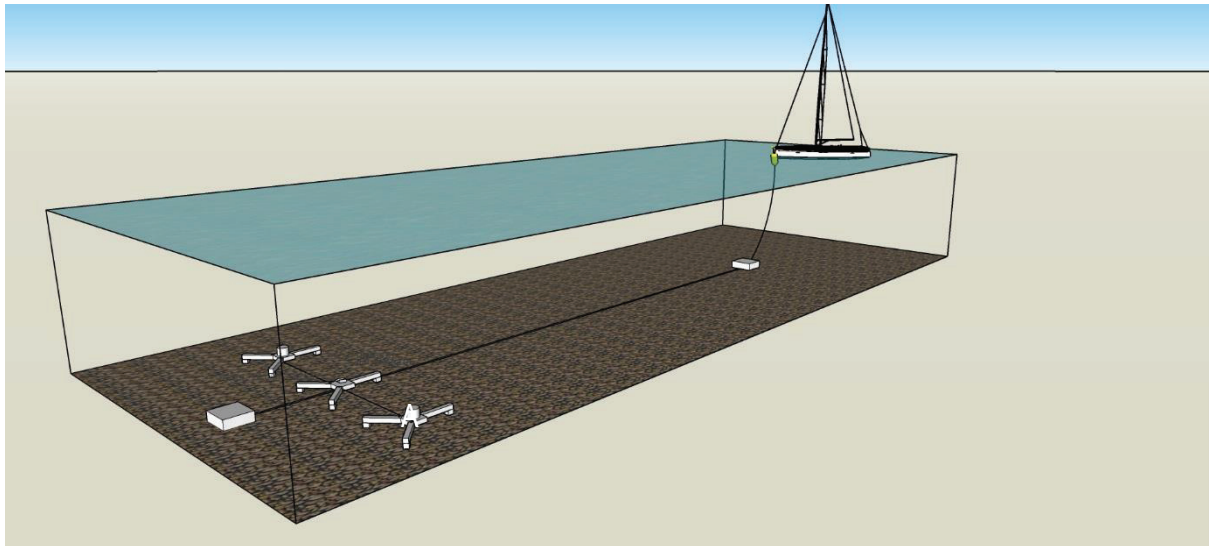
Unfortunately, the VEMCO tag does not encode its identity number and so does not satisfy criterion four, above (be individually identifiable). However, if these animals are also tagged with identifiable GPS transmitting tags (e.g. Fastloc UHF tags), these will provide locational information for each seal and, therefore, any detections of pinger tags on the PAM system can be linked to individual seals based on the GPS tag data.

It is possible that a seal would be able to detect faint clicks from this tag at the start of each transmission, although this possibility requires formal investigation. Furthermore, 83 kHz is within the hearing range of predators of seals [killer whale (*Orcinus orca*) auditory threshold at 80 kHz has been reported as 65-78 dB (Szymanski *et al.*, 1998)] and there is a clear risk that they could passively detect these tags if deployed on seals. It is unlikely that prey species would hear the tags.

### 5.1.3. Sound of Sleet Deployments

The Sound of Sleet site field deployment consisted of three steel tripod HiCUP frames. One held two Gemini 720 kHz multi-beam sonars (see Section 6) and the other two each held a THC unit. The frames were connected to a concrete block attached to a buoy at the surface (Figure 8).

Unfortunately, an error in deployment location led to the equipment being deployed approximately 100 m from the planned location position. This meant that the equipment was deployed in shallower water than was anticipated (~8 m, instead of 15 m) and out of the main current. In addition, the contractor deployed the two PAM HiCUPs 50 m apart rather than the 20 m specified. This had implications for the probability of detecting porpoises simultaneously on both clusters and therefore tracking probability.



**Figure 8:** Configuration of mooring and instrument deployment at the Sound of Sleat.

The two THCs (described above) were deployed on the outer two HiCUPs with the pair of Gemini sonars on the central one (Figure 8), with cables from all three HiCUPs run to a boat moored on a second concrete mooring block some 80 m away in slacker water. Signals from all eight hydrophones were conditioned and amplified on the vessel before being digitised and stored as WAV files using a boat-based computer and data acquisition system sampling at 500 kHz. Occasionally, the vessel would have to leave the mooring, either due to poor weather or the need to resupply. When disconnected, waterproof blanking plugs were fitted to cable ends from the HiCUPs and the cable ends tied off to a buoy and left floating next to the mooring. Passive and active data were recorded continuously 24 hours a day to hard disk drives whenever the vessel was at the mooring.

#### 5.1.4. Alignment and Calibration Trials

Calibration trials were conducted in order to determine both the location and orientation of each hydrophone element on each passive acoustic THC, and to evaluate the localisation accuracy achievable by these devices with representative signals in field conditions. These trials involved broadcasting simulated harbour

porpoise clicks and a frequency modulated click signal from a hydrophone at a known depth.

The calibration system was deployed from a drifting dinghy whose location was determined using GPS. A VHF radio link was used to synchronise the transmission time of each burst of signals on the broad band multi-track recordings made on the research vessel. For some trials, VEMCO “pinger tags” were also deployed to provide information on the tracking accuracy that could be achieved for active acoustic tags using the PAM system, and a sonar target was deployed to determine the location and orientation of the Gemini sonars. Calibration trials were carried out over a total of ~20.5 hours.

Sweeps from the calibration trials were used to localise the THCs by optimising their x, y, z locations, heading, pan and tilt to best fit the data. The simulated porpoise clicks were used to investigate localisation and timing accuracy.

#### 5.1.5. Acoustic Data Analysis

PAM data were analysed using PAMGuard ([www.PAMGuard.org](http://www.PAMGuard.org); Gillespie *et al.*, 2008). An automated click detector with a porpoise click classifier, and whistle and moan detector to detect dolphin whistles, was applied to all collected data. For a narrow band, well defined signal, such as those from the VEMCO tags, an optimal detector would filter incoming data with a narrow band pass filter covering only the frequencies emitted by the tag(s) prior to detection. In principle it would be possible to run separate detectors for VEMCO tags and for cetacean clicks (which require a broader band detection system). While relatively straight-forward in the laboratory, for a future real time system, running two sets of detectors on multiple channels at high frequency would likely require more than one PC to process data at the required rate. Implementing data sharing between two PCs in this way is not possible with current software (Section 5.4), although it could probably be implemented if required. In order to avoid additional time consuming software developments, focus was placed on using a single detector for both cetacean clicks and VEMCO tags and to then separate the various click types using the PAMGuard click classification systems.

The PAMGuard click detector was, therefore, configured to detect transient sounds with energy between 70 and 150 kHz rising 15dB or more above background noise. Detected clicks were automatically classified as dolphin, porpoise or VEMCO tag based on their spectral properties. VEMCO tag sound clicks were identified by their concentration of energy at the known frequencies for these devices, whilst cetacean

and artificial calibration clicks were identified by their energy in the 100-150 kHz band. Sequences of porpoise and dolphin clicks received on either or both PAM clusters were identified by an experienced analyst and grouped into “encounters”. An encounter was defined as an instance when classified clicks grouped in clear click trains were recorded within ten minutes of one another (Figure 9).

If hydrophone locations are accurately known, then sound source localisation accuracy is largely governed by how accurately it is possible to measure time of arrival differences of signals at different hydrophones. In order to improve timing accuracy for the VEMCO tag signals, new timing algorithms were developed specifically for the long VEMCO signals. This work is described in detail in Appendix A.

Generated sounds originating from the same location should generate the same time delay measurements on each hydrophone pair. Timing accuracy was, therefore, measured by comparing time of arrival differences for adjacent generated porpoise clicks and fish tag pings, which being close together in time, would have originated from a very similar location. If each timing measurement error can be assumed to be independent, then the average error on each timing measurement is the difference in time measurements for adjacent clicks divided by the square root of two.

Absolute localisation accuracy was measured by comparing reconstructed locations of the artificial porpoise clicks broadcast during calibration trials with the source location.

Further investigations of localisation accuracy were then conducted with simulations, using the measured timing accuracies from the field trials as input to the simulation. This allowed a comparison of the hydrophone geometry used in these trials with the hydrophone geometry now planned for deployments on a tidal turbine later in 2016 to be made.

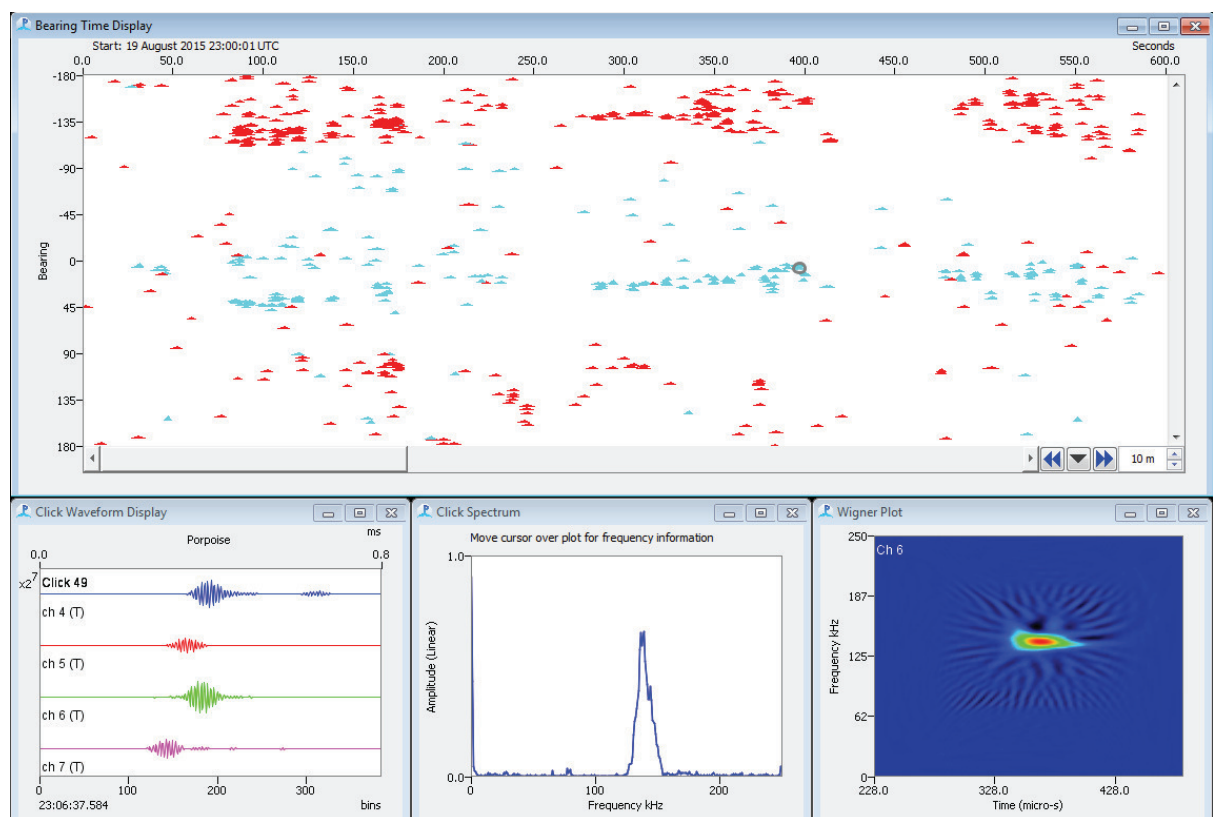
## **5.2. Results**

The PAM system proved to be very reliable with data being collected nearly continuously when the vessel was present from 6 August until recovery on 25 August, 2015. As anticipated, the research vessel occasionally left the mooring and disconnected the HiCUP cables, resulting in gaps in data collection. A total of ~332 hours (~14.83 days) of acoustic data were collected by the HiCUP units (Table 6). Overall, data were successfully recorded for ~79% of the time between the initial

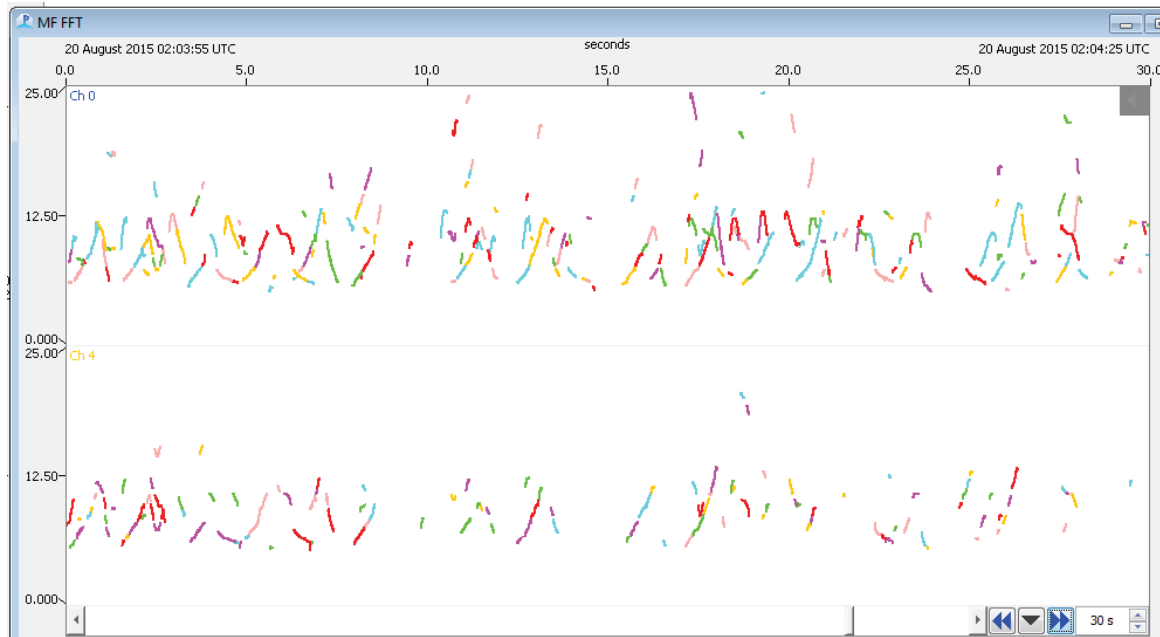
connection and final disconnection (~425.5 h available). In total 13.5 TB of data were collected.

Visual observations during the trials included harbour porpoises, bottlenose dolphins, grey seals, harbour seals, and Northern gannets (*Morus bassanus*).

A pod of ~20 bottlenose dolphins was sighted in the upper Sound of Sleat on 19 and 20 August. Table 6 shows the total number of passive acoustic encounters for both porpoises and dolphins. There were four instances where porpoise and dolphin encounters overlapped. Figure 9 shows a PAMGuard screenshot of a porpoise encounter. Figure 10 shows a screenshot of dolphin whistle detections.



**Figure 9:** Screenshot from PAMGuard showing harbour porpoise click detections on both HiCUP clusters. Clicks are coloured by HiCUP cluster: red denotes the cylindrical cluster (ch. 0, 1, 2, 3) and cyan denotes the spherical cluster (ch. 4, 5, 6, 7). A bearing-time display (10 minutes shown), waveform display, click spectrum, and Wigner plot of a single porpoise click are shown.



**Figure 10:** Screenshot from PAMGuard showing bottlenose dolphin whistle contours (30 s of data shown, 0–25 kHz). The top panel shows one channel (ch. 0) from the cylindrical PAM HiCUP cluster, and the bottom panel shows one channel (ch. 4) from the spherical PAM HiCUP cluster.

**Table 6**

Summary of porpoise and dolphin acoustic encounters.

Marine mammal species encountered	# of encounters	Duration of encounter (mean, min-to-max)	Total duration of encounters (hh:mm:ss)	% of entire recorded time containing encounters
Harbour porpoise	64	00:38:37 (00:00:33 to 04:15:57)	41:11:31	12.4%
Bottlenose dolphin	22	00:35:14 (00:00:43 to 02:35:43)	13:30:21	4.1%
Porpoise and dolphin	4	n/a	4:47:10	1.4%

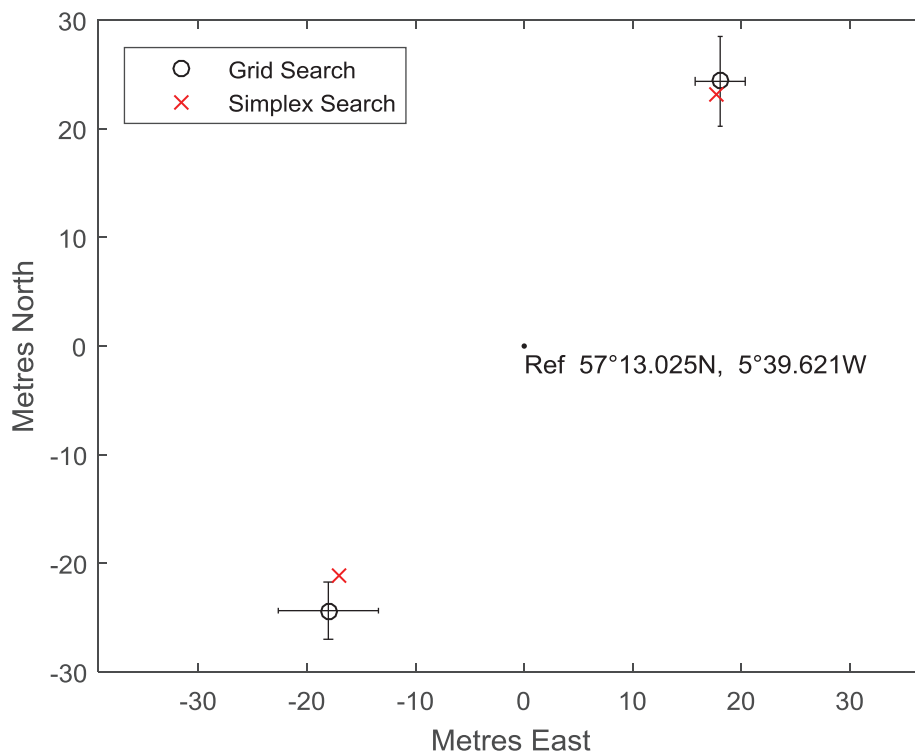
### 5.2.1. HiCUP Location

The location of the HiCUPs was calculated from time of arrival differences from frequency modulated clicks outputted at different known locations around the array. Table 7 shows the locations and orientation results and associated errors calculated using two different optimisation algorithms (grid search and simplex). Figure 11 shows a latitude and longitude plot of the calculated locations and errors for both algorithms. The difference in positions calculated by the two methods for the spherical and cylindrical clusters is 3.4 and 1.2 m respectively.

**Table 7**

Table showing the calculated positions and orientations of the hydrophone clusters along with associated errors in each measurements. Note that the grid search assumed pitch and roll was zero.

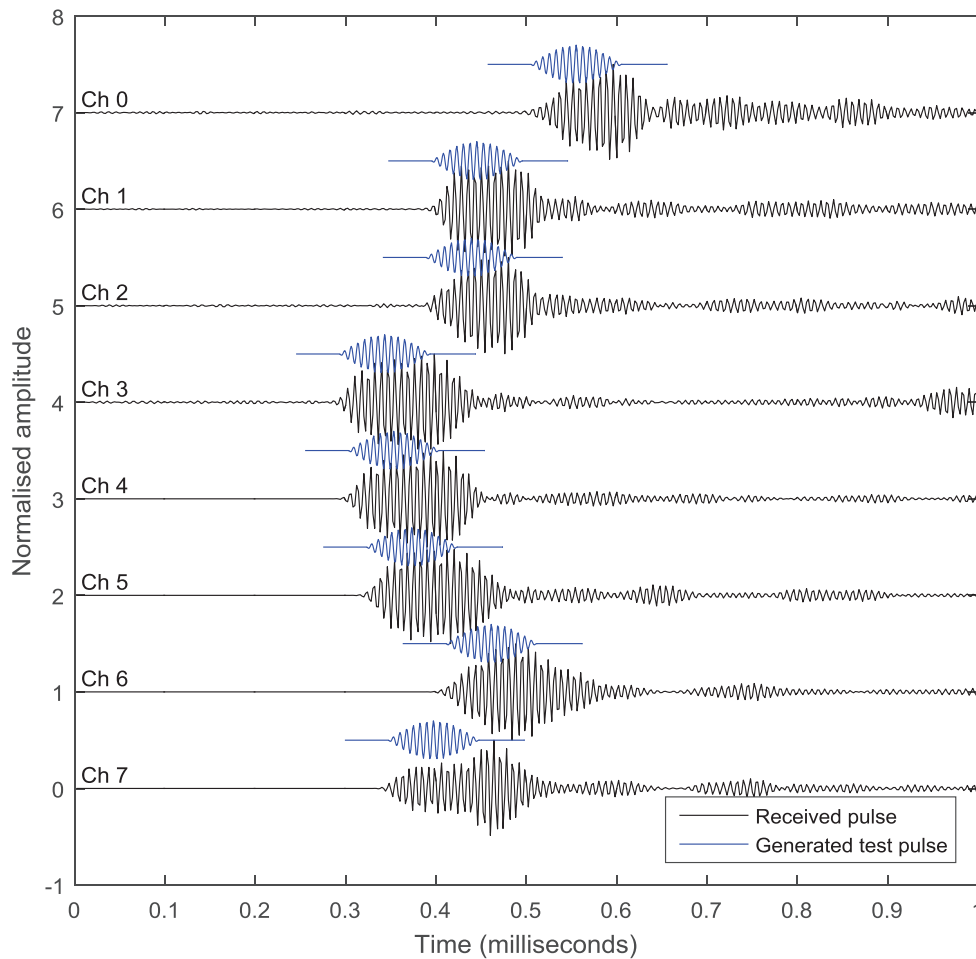
PAM HICUP type	Latitude	Longitude	Depth (m)	Heading (degrees)	Pitch (degrees)	Roll (degrees)
<b>Grid Search</b>						
Spherical	$57.21730772 \pm 3.72 \times 10^{-5}$	$-5.660049997 \pm 3.83 \times 10^{-5}$	$-7.8 \pm 0.94$	$150 \pm 3.06$	-	-
Cylindrical	$57.2168693 \pm 2.37 \times 10^{-5}$	$5.660649391 \pm 7.66 \times 10^{-5}$	$9.9 \pm 0.79$	$320.5 \pm 3.7$	-	-
<b>Simplex</b>						
Spherical	57.2172972	-5.6600553	8.75	150.9	-2.9	0.6
Cylindrical	57.2168987	-5.6606335	7.83	317.7	-2.8	4.4



**Figure 11:** The calculated position of the HiCUPs using two different minimisation methods, grid search and simplex.

### 5.2.2. Timing Accuracy

Figure 12 shows typical received pulse waveforms from a 120 kHz ‘porpoise’ signal generated during a calibration trial. For comparison, the figure also shows the original pulse waveform, time aligned to the start of the received pulse on each channel. Significant and differing signal distortion and multiple echoes of the signal following each received pulse are clearly visible on all channels.



**Figure 12:** Example pulses received on all eight hydrophones (four in each cluster) from a pinger calibration trial using porpoise like clicks. Shown with each received pulse is the pulse used to generate the calibration sound aligned to have the same start time as each received pulse. Distortion of the pulses and multiple echoes following each pulse are clearly visible.

Alignment problems with the HiCUPs and small uncertainties in the location of the drifting sound source, make it difficult to accurately assess timing accuracy based on the difference between measured received times at the hydrophones and expected received times based on the system geometry. Timing accuracy was, therefore, investigated by comparing the time delays of adjacent clicks during the experiments



with an artificial sound source. With zero timing error, the difference in time delays between adjacent clicks should be negligibly small, so any difference is presumably caused by errors in the timing measurements. Timing accuracy and algorithms for extracting time of arrival differences are discussed in Appendix A.

**Table 8**

Summary of timing errors for porpoise like clicks and VEMCO fish tags using different cross correlation methods.

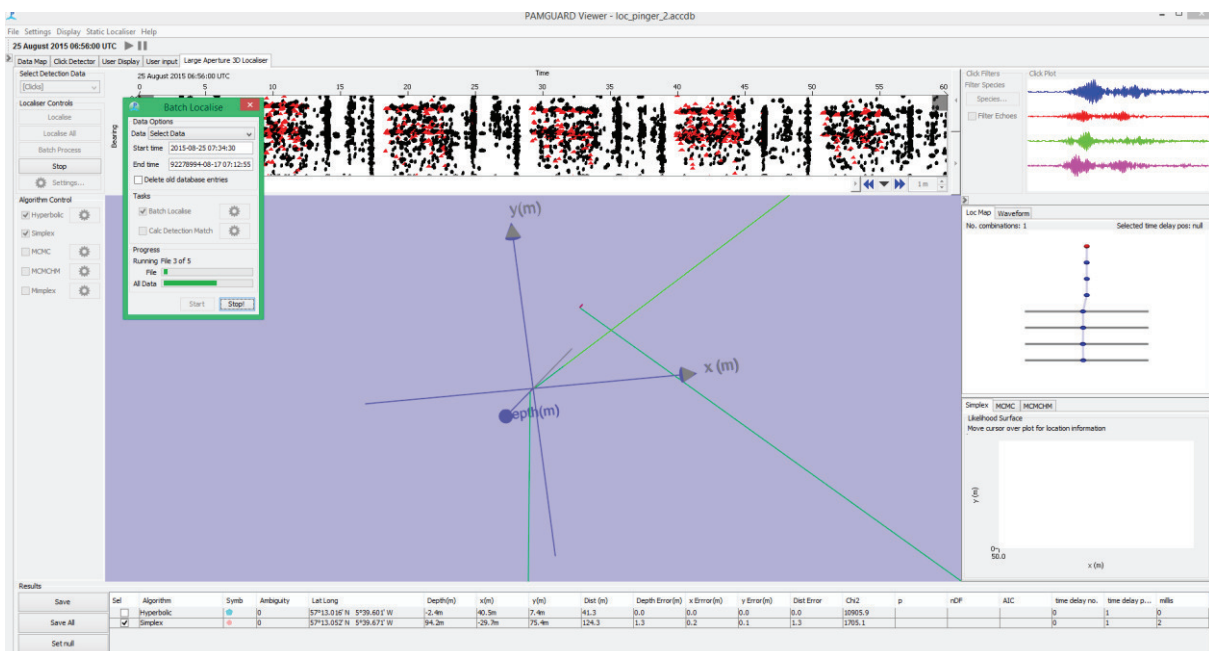
Signal Type	Waveform Correlation		Envelope Correlation		Envelope Edge Correlation	
	Cylinder	Spherical	Cylinder	Spherical	Cylinder	Spherical
Porpoise	6.3 $\mu$ s	5.1 $\mu$ s	6.2 $\mu$ s	4.7 $\mu$ s		
VEMCO tags	31.1 $\mu$ s	25.5 $\mu$ s	21.1 $\mu$ s	14.6 $\mu$ s	11.5 $\mu$ s	7.4 $\mu$ s

Measurements of timing accuracy for both hydrophone clusters and different correlation methods are shown in Table 8. It can be seen that for the porpoise clicks, there is little difference between waveform and envelope correlation. In comparison, for the long duration VEMCO tag signals, there is a three-fold improvement in timing accuracy when envelope edge correlation is used in preference to waveform correlation.

It can also be seen that timing accuracy is consistently better on the spherical hydrophone cluster than on the cylindrical one. In addition to differences in the hydrophone ceramic, there were two important differences between the two clusters. One was the shape of the cowling, where the cylindrical cluster cowling had a flat top and the other a domed top. The other difference was in the spacing between hydrophones, which was 30 cm for the cylindrical cluster and 15 cm for the spherical cluster. The wider hydrophone spacing meant that hydrophones were closer to the cowling material, so the time delay between the incident signal and any echo from the structure was shorter than for the more tightly spaced hydrophones (7.7 cm and 16.3 cm respectively, giving two way travel times of 102 and 218  $\mu$ s). The longer spacing between clicks and echoes in the cylindrical cluster would mean they were less likely to overlap and distort the waveforms. It is, therefore, possible that the signals on the more widely spaced hydrophones were more distorted by echoes than on the closely spaced cluster.

### 5.2.3. Localisation Accuracy

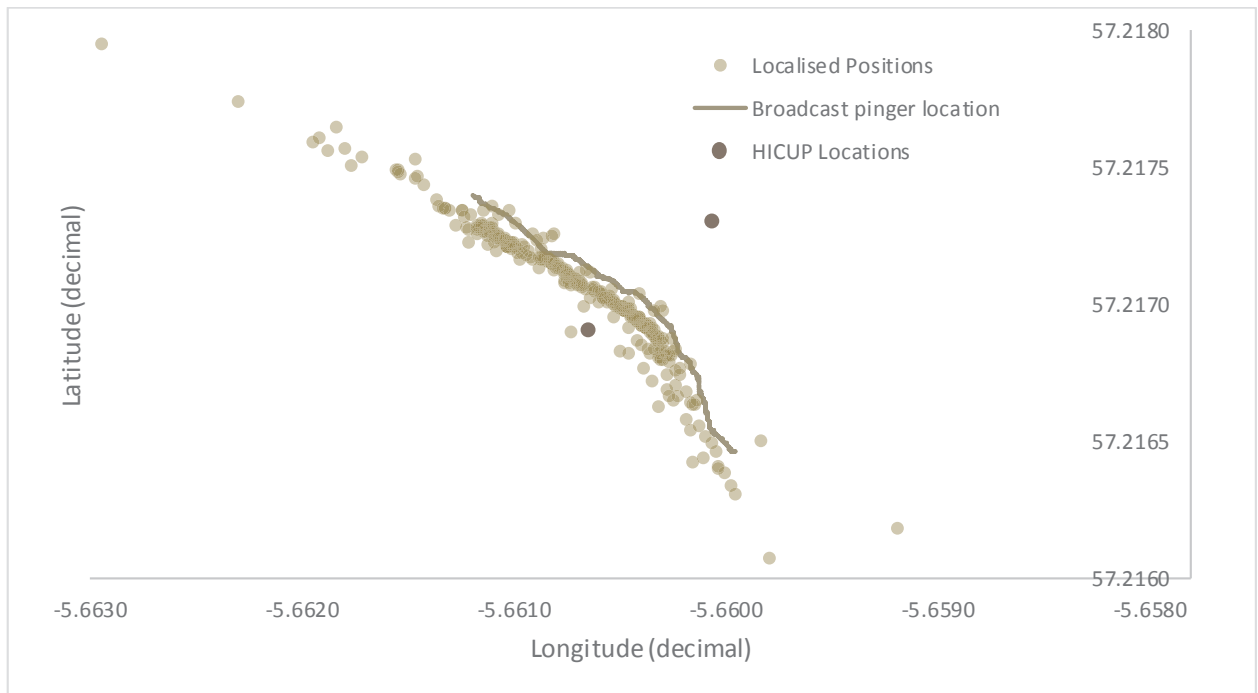
Once the location and orientation of each HiCUP was determined (Section 5.2.1), the broadcast porpoise pings were localised in order to determine the absolute tracking accuracy of the array. Detected broadcast pings were passed to the PAMGuard Large Aperture Localiser Module (Figure 13). This module outputs the latitude, longitude and depth of each broadcast sound detected on both HiCUPs. Localisations were then compared to the true position of the broadcast pinger and the error estimated for different ranges.



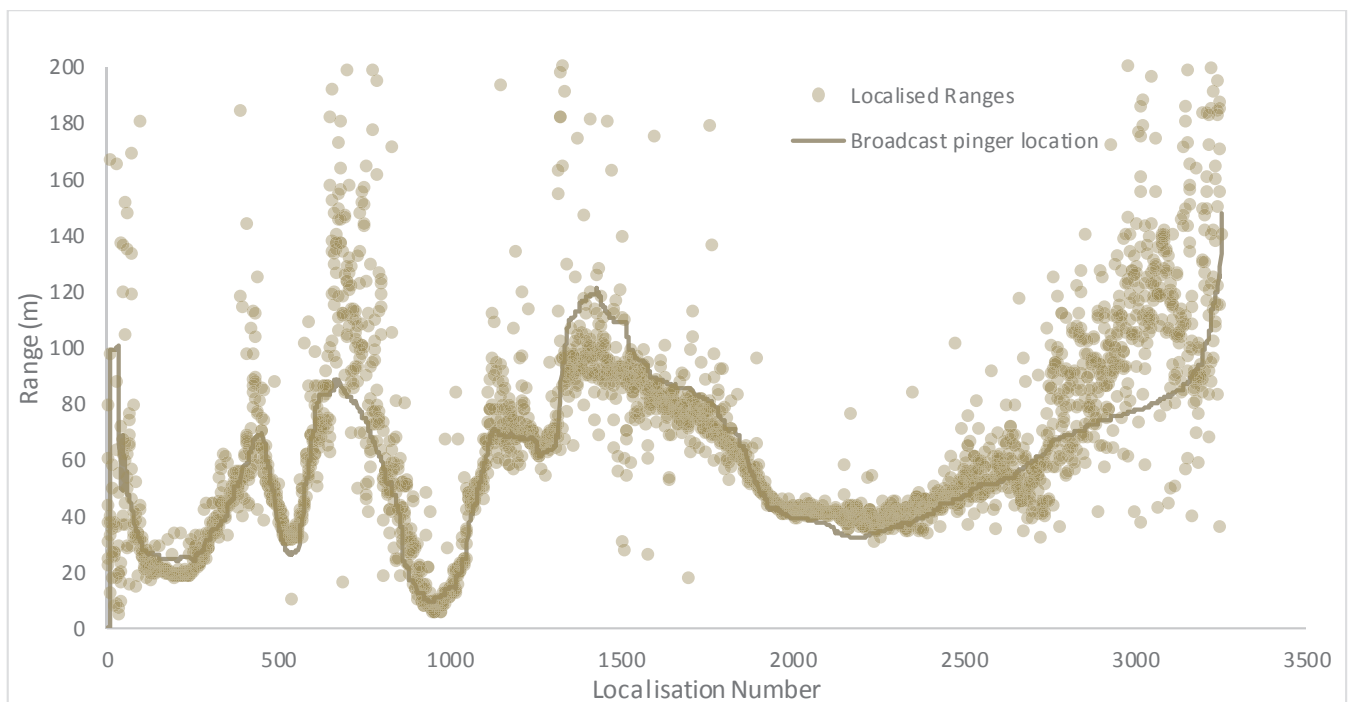
**Figure 13:** The PAMGuard Large Aperture Localiser module used to localise the position of simulated sounds and harbour porpoise and dolphin clicks.

#### 5.2.3.1. Localising the Position of Broadcast Pings

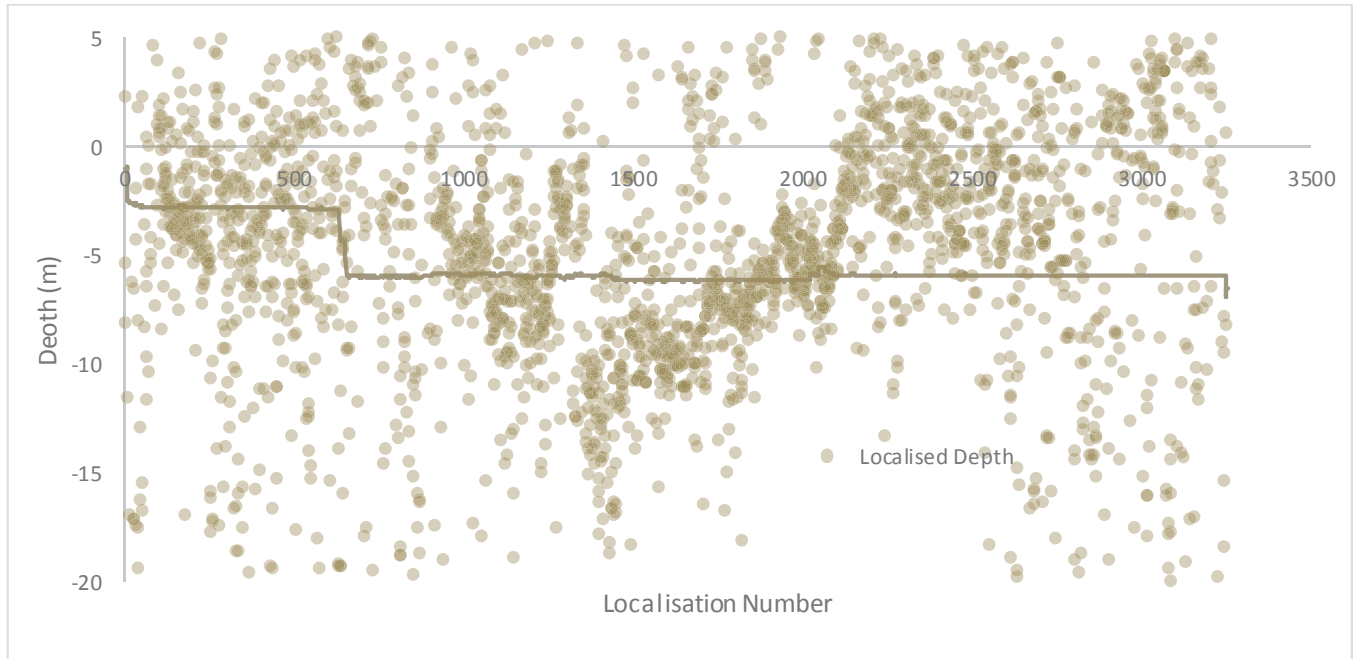
Figures 14, 15 and 16 show the position, range and depth of the broadcast pings compared with reconstructed positions from data collected on the THC array. The true location of the broadcast pinger was compared to the localisation results and resulting errors calculated. Figures 17, 18 and 19 show range, depth and angular errors divided into 25 m range bins.



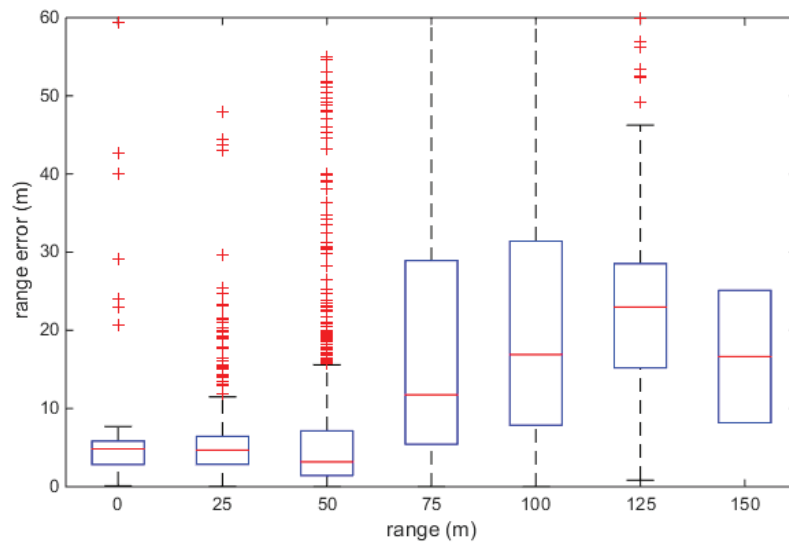
**Figure 14:** A sample of the latitude and longitude of the broadcast pinger and the localised position calculated from acoustic data collected on the HiCUP array.



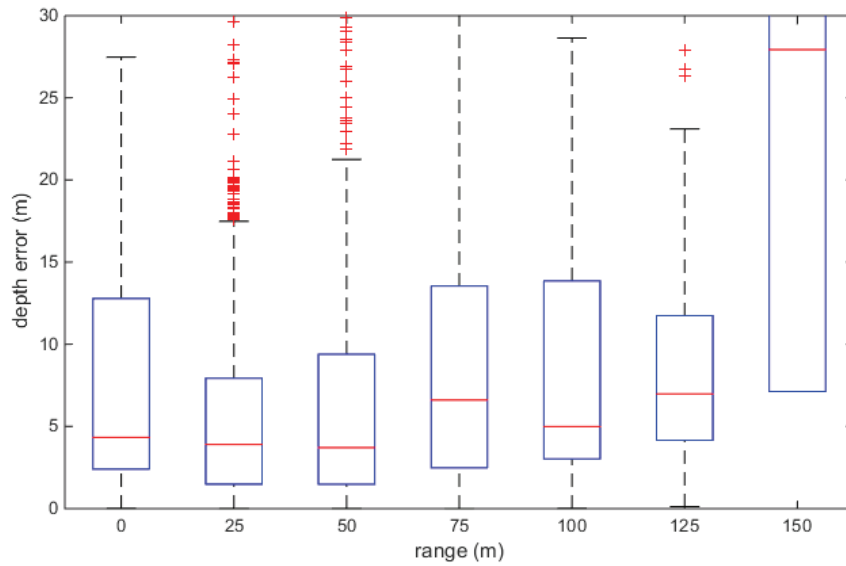
**Figure 15:** The range of the broadcast pinger and localised ranges calculated from the acoustic data collected on the HiCUP array. The localised ranges broadly follow the true range of the broadcast pinger.



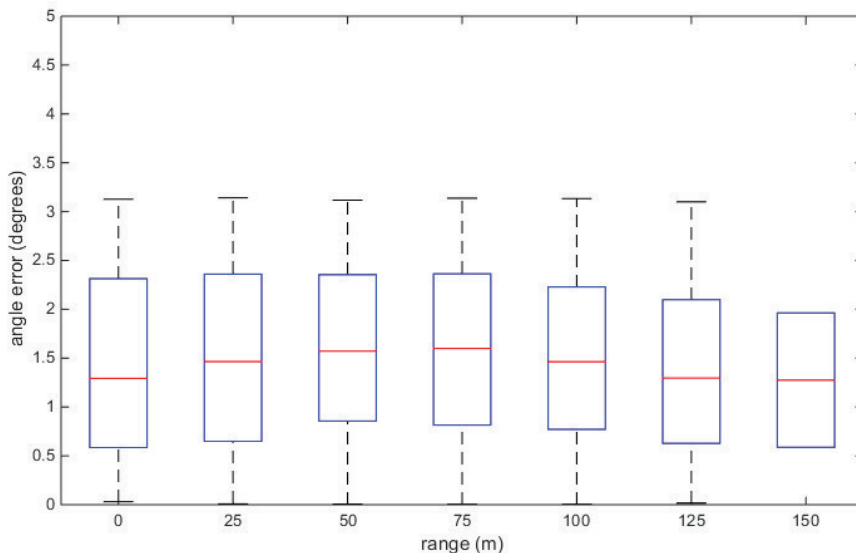
**Figure 16:** The depth of the broadcast pinger and localised depths calculated from the acoustic data collected on the HiCUP array.



**Figure 17:** Box plots showing the median error in localised range of the broadcast pinger versus the true range of the broadcast pinger.



**Figure 18:** Box pots showing the error in localised depth of the broadcast pinger versus the range of the broadcast pinger.

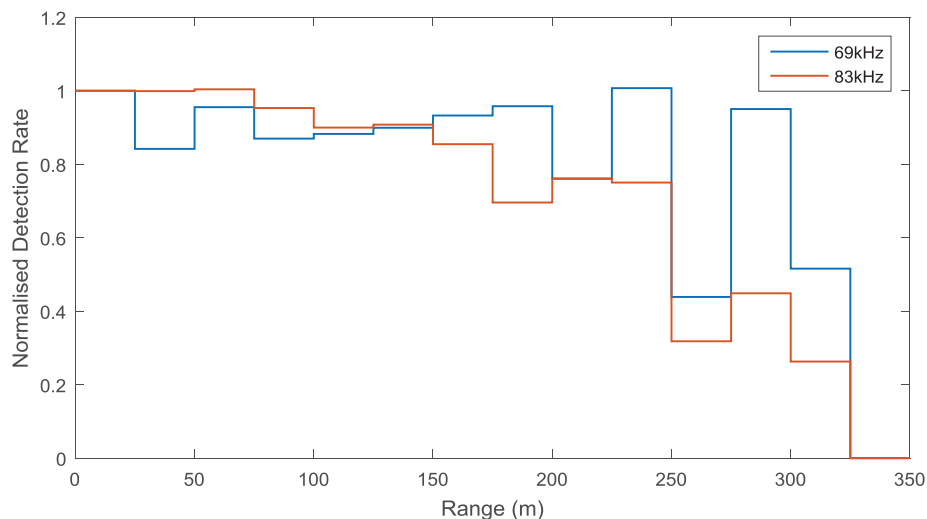


**Figure 19:** Box plots showing the error in the angle to the broadcast system versus the true range of the broadcast system.

The systematic offsets in Figure 14, in which estimated localisations of the sound source appear to the south west of the true locations are indicative of an offset (i.e. a systematic error) in the location of the HiCUP clusters. Generally, range error is small (3-6 m) out to about 50 m from the array. Depth error appears to be higher and more variable at least several meters at all ranges. It has not been possible to fully ascertain the cause of this, but it is most likely caused by a tilting of the HiCUP clusters.

### 5.2.4. Fish Tag Detection Range

In order to assess detection range, two types of fish pinger tags were suspended below a slowly moving inflatable in the vicinity of the THC's: a 83 kHz tag (the tag that is proposed to fit on seals) and a 69 kHz tag. The exact times and numbers of transmissions of pings is not known, so the numbers of received pings per unit time was compared with the amount of time the drifting dingy spent in each range bin. Most data were collected with the tags within 100 m of the HiCUPs and few data were collected at ranges greater than 200 m. However, from Figure 20 it can be seen that detection rate of both tags is reasonably flat out to 100 m and some detection occurs out to at least 250 m.



**Figure 20:** Detection rates for 69 and 83 kHz VEMCO fish tags as a function of transmission distance.

It should be remembered that the detection parameters used for this trial were not optimised for the VEMCO tag signals, but were generic settings designed to detect echolocation clicks over a wide bandwidth. If the detection parameters were optimised for this type of sound, it is likely that much greater detection ranges could be achieved although localisation accuracy could be compromised.

### 5.3. Localisation Error Simulation

Measurements of localisation accuracy (presented in Section 5.2) may underestimate the likely localisation accuracy of a system installed on an operational turbine for two main reasons. Firstly, there were problems with the alignment of the THC's and this will have contributed to the errors described in Section 5.2.3. Secondly, the current plan is now to install three hydrophone clusters on one of the turbines installed at the MeyGen site, one cluster on each of the three legs. The

improved alignment that will be achieved by mounting on the turbine structure, combined with an increased number of hydrophones in a different geometry should improve tracking accuracy.

Localisation accuracy was, therefore, investigated using simulations, both for the HiCUP configuration of two THC's 50 m apart and also for a system consisting of three clusters in a triangular configuration with a nominal 10 m spacing.

The hydrophone clusters in the simulation were set at 10 m depth. The PAMGuard sound acquisition module was used to create a series of simulated clicks positioned on a 100 x 100 m grid with depths at 0 m, 5 m and 10 m. Errors in sound speed, hydrophone location and click cross correlation were all incorporated into the simulation using the values shown in Table 9. The timing error of 5  $\mu$ s is taken from the timing accuracy measurements presented in Table 8. A Markov chain Monte Carlo (MCMC) based localisation algorithm was then used to localise each simulated click in the PAMGuard Large Aperture Localisation Module. The MCMC algorithm creates a dynamic representation of error distributions and hence can predict where areas of high and low localisation error might occur around a hydrophone array. Surface plots of the errors estimated through simulation are shown in Figure 21. Localisation accuracy in line with the two clusters is extremely poor once outside the space between the clusters, since movement away from the THCs creates no changes in time differences. Localisation accuracy with two clusters is reasonably directly perpendicular to the two clusters, the error in range being: < 3 m; depth < 2 m and angle < 0.7 degrees at 25 m. With three clusters, localisation accuracy improves, the average error in range being < 3 m; depth < 0.7 m and angle < 0.5 degrees at 25 m.

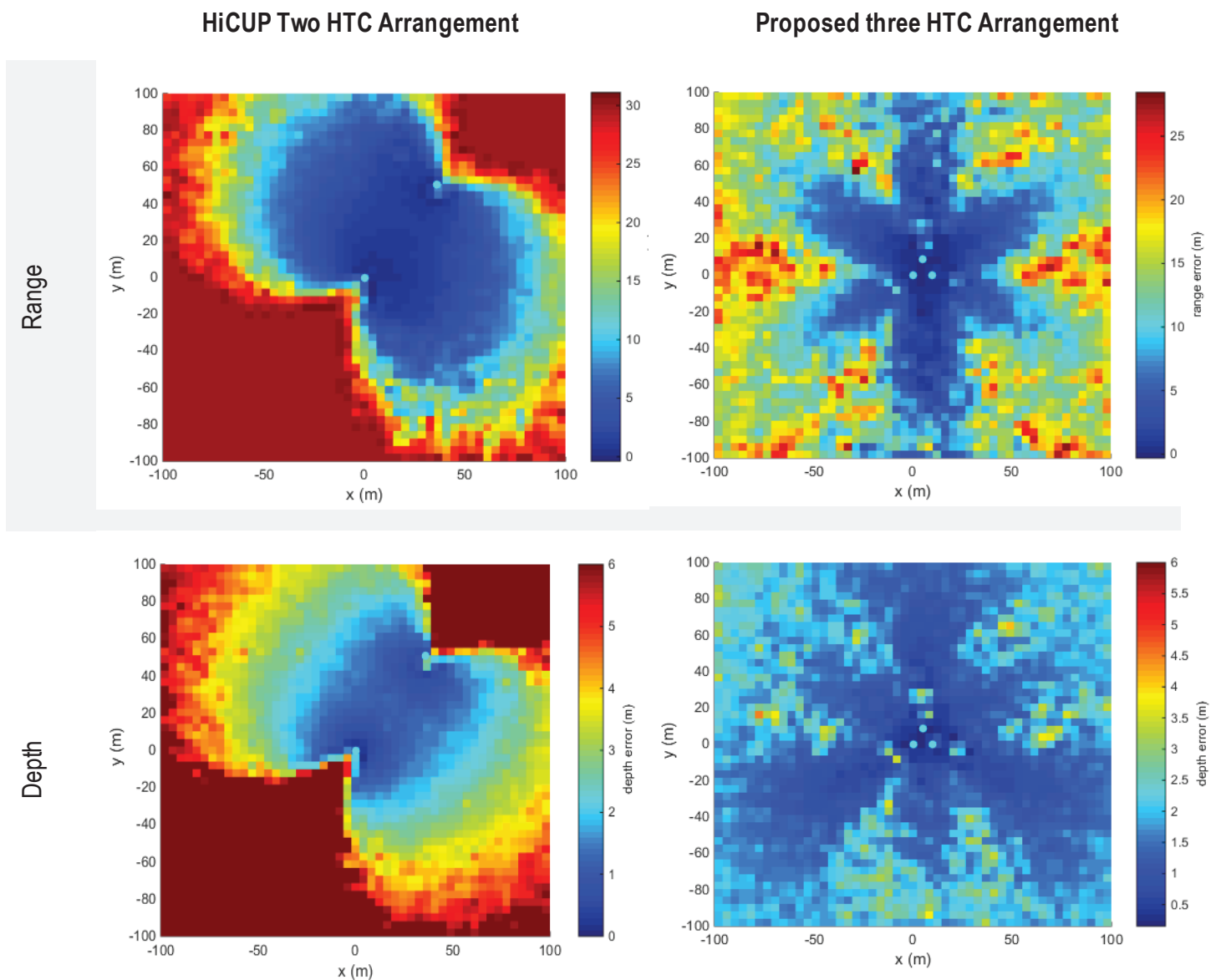
Except at close range, there is broad agreement between the measured and simulated errors in range and depth for the HiCUP THC configuration (Figure 22). Measured angle errors are consistently worse than the simulated errors. This difference is attributed to problems accurately aligning the HiCUP THC clusters during the field trials. The broad scale agreement means that, should alignment issues be resolved, either array configuration could provide accurate tracking around an operational turbine.

Simulations were also conducted using a slightly higher timing error of 7.5  $\mu$ s, which is the timing error achieved when using the VEMCO tag signals. It was found that the increased timing error made very little difference to localisation accuracy at ranges of less than 70 m, indicating that it should also be possible to track tagged seals using the PAM system to 1-2 m accuracy in the vicinity of the turbine blades.

**Table 9**

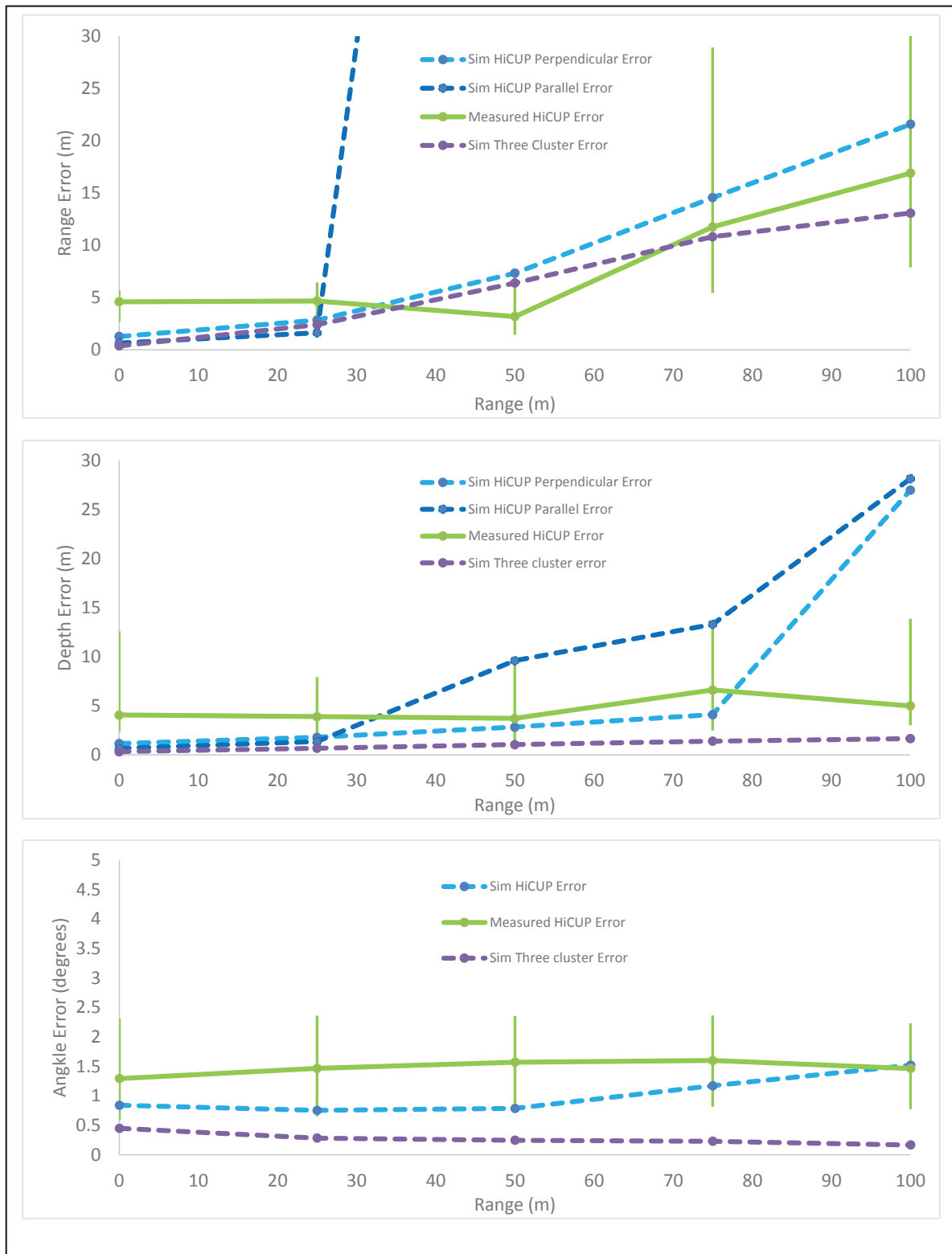
Error values in the simulation of hydrophone array accuracy.

Error Type	Error value
Sound Speed Error	10 ms <sup>-1</sup>
Hydrophone position Error	1 mm
Cluster Position Error	3 cm
Cross correlation error	5 μs



**Figure 21:** Simulated error surface for the HiCUP array and the proposed array to be deployed on a tidal turbine. The errors were calculated using a Markov Chain Monte Carlo based localisation algorithm to accurately estimate probability distribution in location. The estimated errors input into the model are shown in Table 9.





**Figure 22:** Measured and simulated errors for the HiCUP configuration and for a three cluster geometry. For the two cluster HiCUP geometry, errors are shown along a line parallel to the two clusters and a line perpendicular to them. For the three cluster geometry, errors for all angles are grouped together. These are overlaid with measured errors from the 2015 field trials.

## 5.4. Data Acquisition and Processing Development

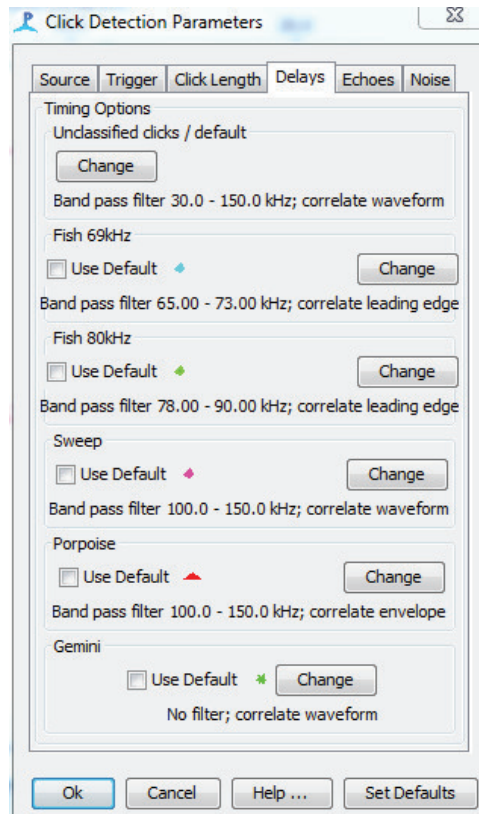
To achieve the full functionality required for operation on a tidal turbine, two significant software developments have been undertaken. The first is in support of accurate timing (and, therefore, localisation) of fish tag detection, the second is to support higher data throughput from a twelve hydrophone PAM system.

### 5.4.1. Click Timing Measurements

To allow different time of arrival delay (TOAD) measurement algorithms to be used with different click types, the PAMGuard software was modified so that the choice of TOAD algorithm is selected separately for each category of classified clicks (see Appendix A). For each click type, it is now possible to define:

1. A filter to apply to the waveform data after detection and before TOAD measurement, to limit analysis to frequency bands of interest.
2. Whether to cross correlate the filtered waveform or the waveform envelope.
3. An option to use only the leading edge of the waveform envelope for cross correlation.

As with all PAMGuard development, these additions to the code are freely available to all users and developers under the GPL3 open source licence agreement (<http://www.gnu.org/licenses/gpl-3.0.en.html>). Examples of the configuration dialogs are shown in Figure 23.



**Figure 23:** Configuration dialogs for click type specific timing measurement.

#### 5.4.2. Data Acquisition System

During the 2015 field trials, data acquisition used two or three USB connected SAIL Daq Cards (St Andrews Instrumentation Ltd., <http://www.sa-instrumentation.com/>). Unfortunately, these are not suitable for deployment in a remote turbine site due to the limitations in USB cable lengths. For remote deployment, a new Data Acquisition system has been developed, based around a National Instruments cRio 9067 chassis equipped with NI 9222 analogue input modules, capable of sampling at 500kS/s on each channel. This is a significant development upon earlier work using a NI cDaq 9188 chassis which has been deployed on a similar installation. Since purchasing the 9067 chassis a smaller four slot version has become available which offers some space savings over the 9067.

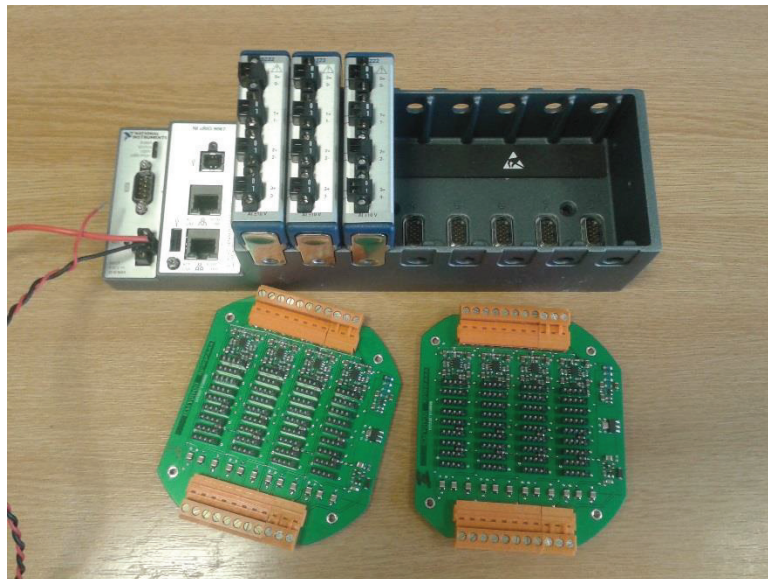
The main difference is that the earlier 9188 chassis was a 'dumb' device which was only functional when being controlled directly by the host PC. The 9067 has its own internal processor which has been programmed to acquire, compress, and buffer data prior to transmission to the host computer. When acquiring high sample rate data on many channels, the 9188 based system can drop out due to buffer overflows when it fails to transmit data sufficiently quickly to the host PC. This then requires a restart of the system which can take several seconds. Using the 9188 chassis, this

was a serious problem when an Ethernet connection to the chassis was shared with other devices, but was less of a problem when a dedicated optical fibre was used for the NI-9188 to PAM PC connection alone. One of the advantages of the new system is that data compression and increased buffering are on the on-board computer. Compression reduces the network bandwidth required by a factor three, and stability will also be improved by increased buffering. Thus, the new system will provide a more stable acquisition platform, particularly when sharing an Ethernet with other devices.

The NI 9067 development was started in order to provide a fully autonomous data acquisition capability for a separate Scottish Government funded project (Macaulay *et al.*, 2015). Like PAMGuard, all developments for the NI chassis are being made freely available under open source licence agreements.

In addition to software developments, the development of small circular format preamplifier boards have been commissioned, suitable for mounting within a pressure housing. These are required between the hydrophones and the NI chassis and have been developed by Etec, Denmark (<http://www.etec.dk/>). Design rights remain with Etec and units can be purchased on commercial terms for other projects.

The NI 9067 Chassis and Etec preamplifiers are shown in Figure 24. Tests of this chassis and of preamplifiers designed for the “front end”, i.e. mounting close to the hydrophone elements within each THC, are on-going to ensure system reliability and stability.



**Figure 24:** Photograph of the NI Chassis and Etec preamplifier boards purchased for this project.

## **6. Active Sonar System Testing and Development**

Previous research into the application of active sonar to complement the PAM and to track non-vocal marine mammals (e.g. seals) around tidal turbines (Hastie, 2012), showed that high frequency multi-beam sonar can be used to reliably image seals in tidal environments and provide a potential means of tracking them around tidal turbines. Although the multi-beam sonar identified in the previous study is potentially an extremely useful tool, a number of limitations that would benefit from further work were highlighted resulting in a series of development recommendations being made (Hastie, 2012). Specifically, in terms of measuring fine scale behaviour of animals around tidal turbines, the multi-beam sonar did not provide data on the depth of the targets; the development of a 3D sonar system was identified as potentially being highly beneficial for measuring tracks of marine mammals around turbines. Furthermore, the automated marine mammal classification system developed in the previous study (Hastie, 2012) appeared highly conservative and resulted in a high proportion of false positive classifications; it was, therefore, recommended that new algorithms be developed and validated to improve the classification and reduce the need for post hoc processing.

The primary aims of the active sonar component of this study therefore sought to address these development requirements through the following tasks:

1. Develop a technique to track marine mammals in 3D using active sonar and test these in a tidally energetic environment;
2. Reduce uncertainty in the classification of marine mammals in multi-beam sonar data through the development of new automated classification algorithms.

Furthermore, there were a number of secondary aims that were identified during the current project:

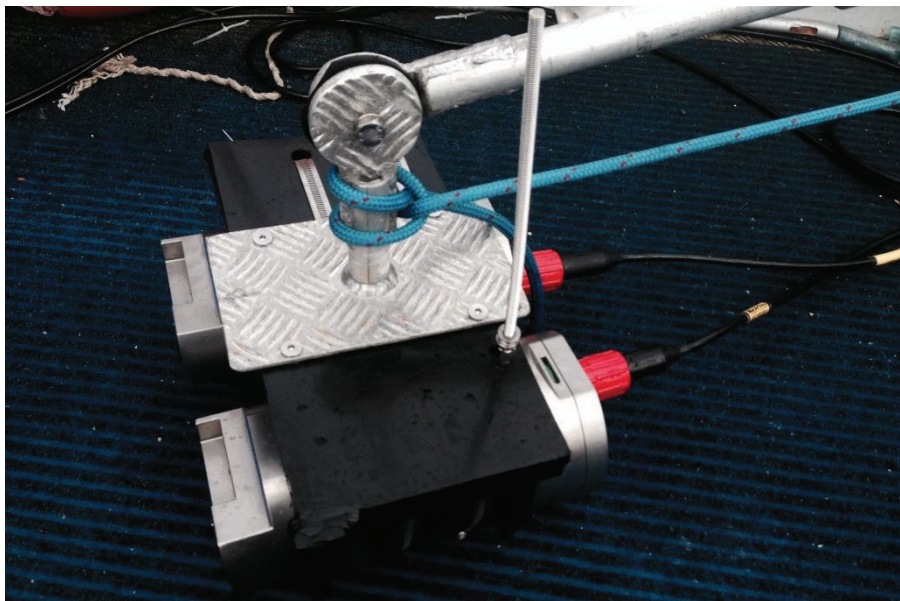
3. Test the passive detection capabilities of multi-beam sonars for external acoustic signals including harbour porpoise clicks and VEMCO acoustic tags;
4. Test the imaging effects of different plastics that could potentially be used as a cowling for the multi-beam sonars.

### **6.1. 3D Marine Mammal Tracking using Multi-beam Sonar**

To develop a sonar system to measure the 3D movements of non-vocal species (e.g. seals) around tidal turbines, a multi-beam sonar system previously identified as

having the potential to track seals in tidal environments was selected (Tritech Gemini 720id, Tritech International Ltd, Aberdeen, UK); this is a 720 kHz forward looking multi-beam sonar that is designed for detecting objects in the water column. It is effectively a 2D imaging system that allows detection and localisation of objects in the X-Y plane but does not provide information on the depth of the target. The image update rate of the sonar is between 7 and 30 Hz, the angular range resolution is  $0.5^\circ$ , and the range resolution is 0.8 cm. The horizontal and vertical swathe widths of the Gemini are  $120^\circ$  and  $20^\circ$  (-3 dB swathe) respectively and up to 4 heads can be operated simultaneously by synchronising the sonar pings.

The seal detection and tracking capabilities of the Gemini formed the foundation of a 3D tracking system. Specifically, dual sonar units were integrated and mounted in different orientations to test the optimum solution for tracking seals in 3D. Data were collected using two Gemini sonars deployed using a custom built sonar mount which allowed both the horizontal and vertical orientations of the sonars to be modified in the field (Figure 25). This was deployed from the side of a 7.5 m aluminium vessel and data were stored to external HDDs using a laptop PC located in the cabin of the vessel.



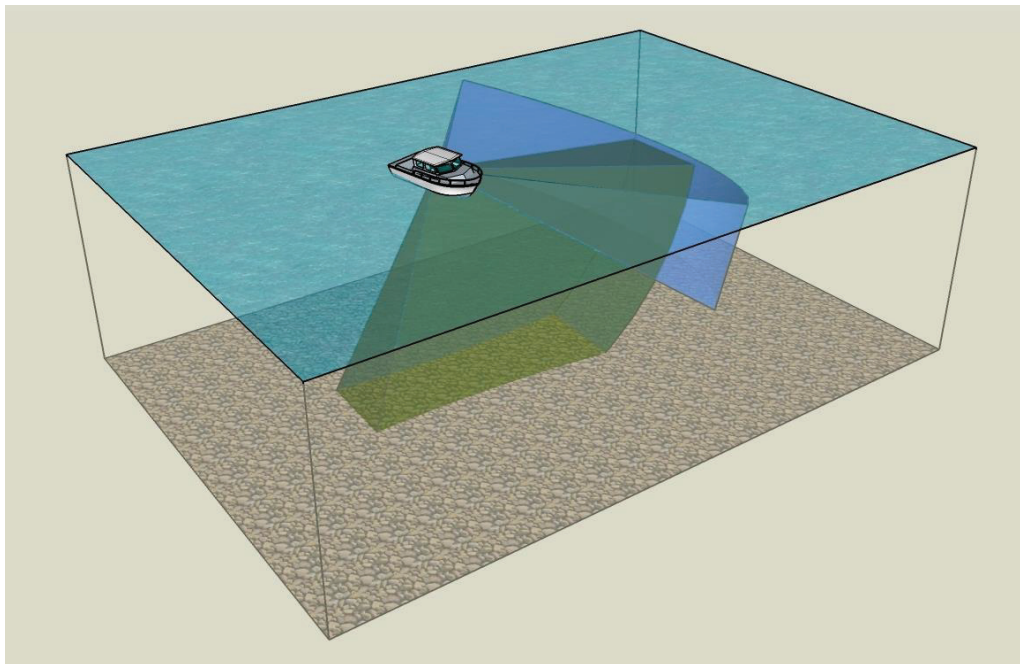
**Figure 25:** Photograph showing the two Gemini multibeam sonars mounted on a boat based mounting pole. Pivots on the pole allowed both the horizontal and vertical angles of each sonar to be modified prior to deployment.

Two methods of 3D tracking were trialled; one where the sonar swathes were mounted in a perpendicular orientation (Figure 26), and one where they were mounted in an offset parallel orientation (Figure 27). To calibrate both of these techniques, an inflatable vessel manoeuvred to a range of between approximately

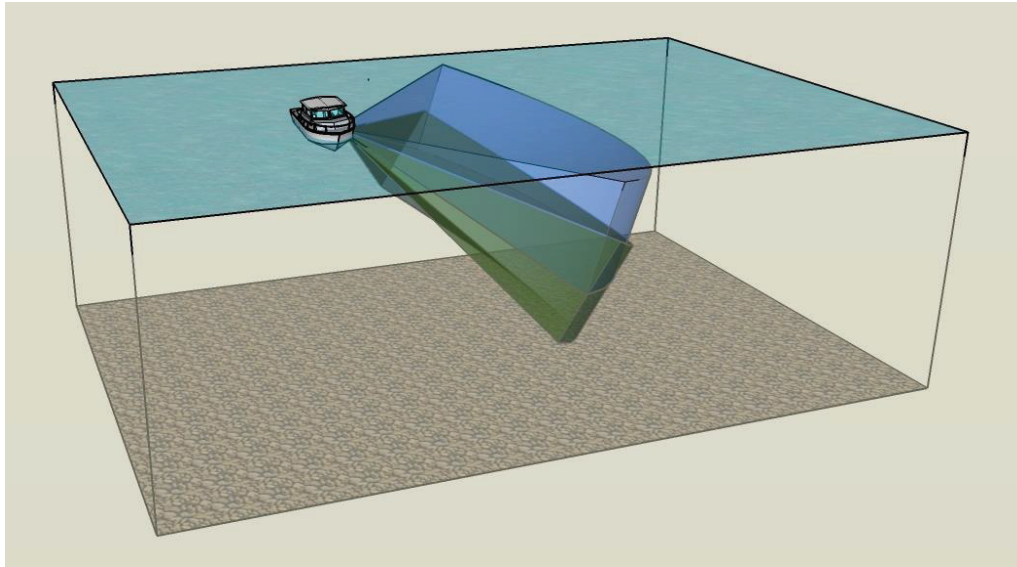
20-40 m from the sonar and a grey seal carcass (1 m in length) was deployed underwater from the vessel using a custom built harness and a 50 m rope. The seal carcass had been frozen within hours of death and was defrosted 48 hours prior to the field trials. An OpenTag depth logger (Loggerhead Instruments, Sarasota, FL, USA) was attached to the seal to calibrate the depth estimates (pressure sensor in the logger had been factory calibrated to provide 0.5 cm depth resolution to 300 m) made using the sonars. In addition, a series of data of live seals diving freely in a tidally energetic environment were collected using each method.

#### 6.1.1. Perpendicular Orientation Technique

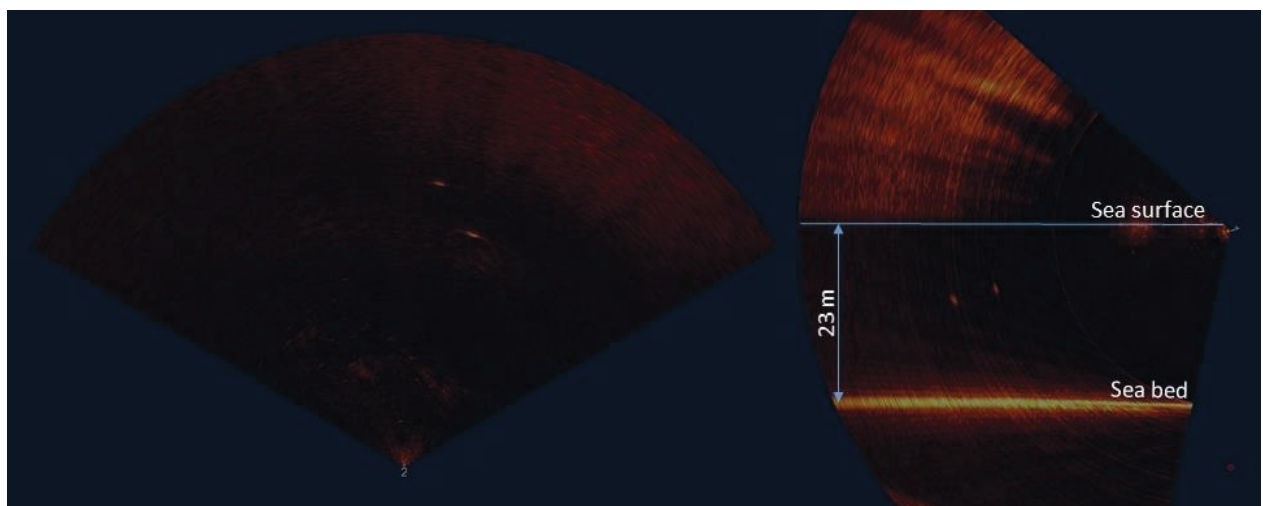
The first approach was to mount the two sonars in perpendicular planes (i.e. one was mounted horizontally and the other vertically) such that there was a region of the water column where the sonar swathes overlapped (Figure 26). This approach was calibrated using a grey seal carcass which was raised and lowered through the sonar beams to the seabed (40 m). The seal carcass was easily observed as a temporally persistent, highly localised pattern of high intensity pixels in the sonar images. The X-Y locations of the seal carcass were measured manually every second on the horizontally mounted sonar using the software SeaTec (Version 1.18.11.12, Tritech International Ltd, Aberdeen, UK). The corresponding depth of the seal carcass was measured on the vertically mounted sonar by measuring the distance between the sea surface or seabed and the seal carcass (Figure 28).



**Figure 26:** Schematic of the acoustic swathes (shown by the blue and green polygons) when the dual sonars were deployed from the research vessel in a perpendicular orientation.



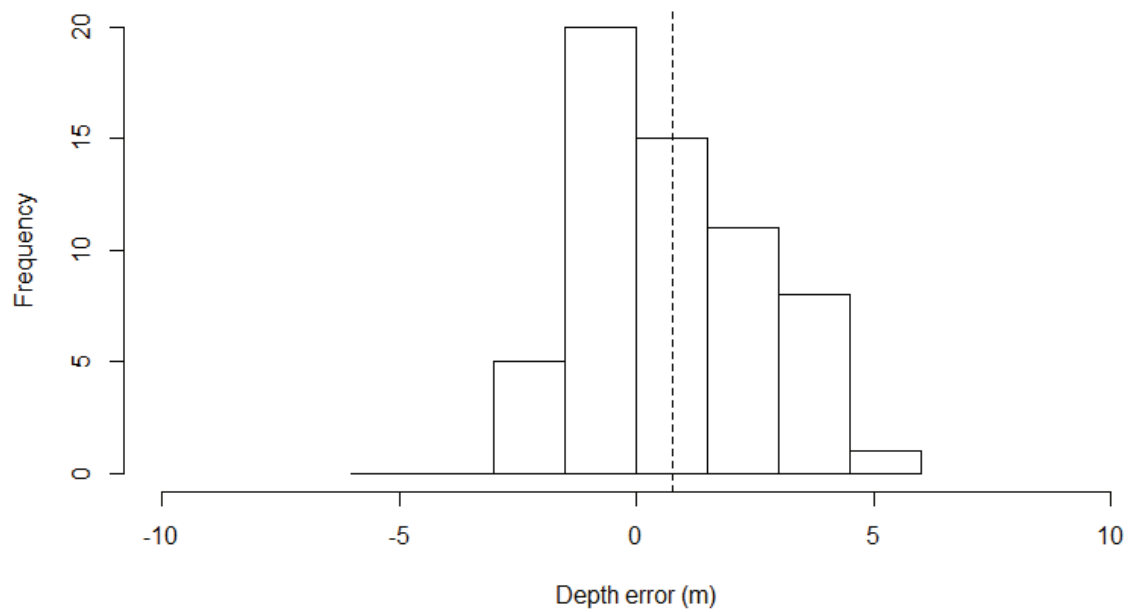
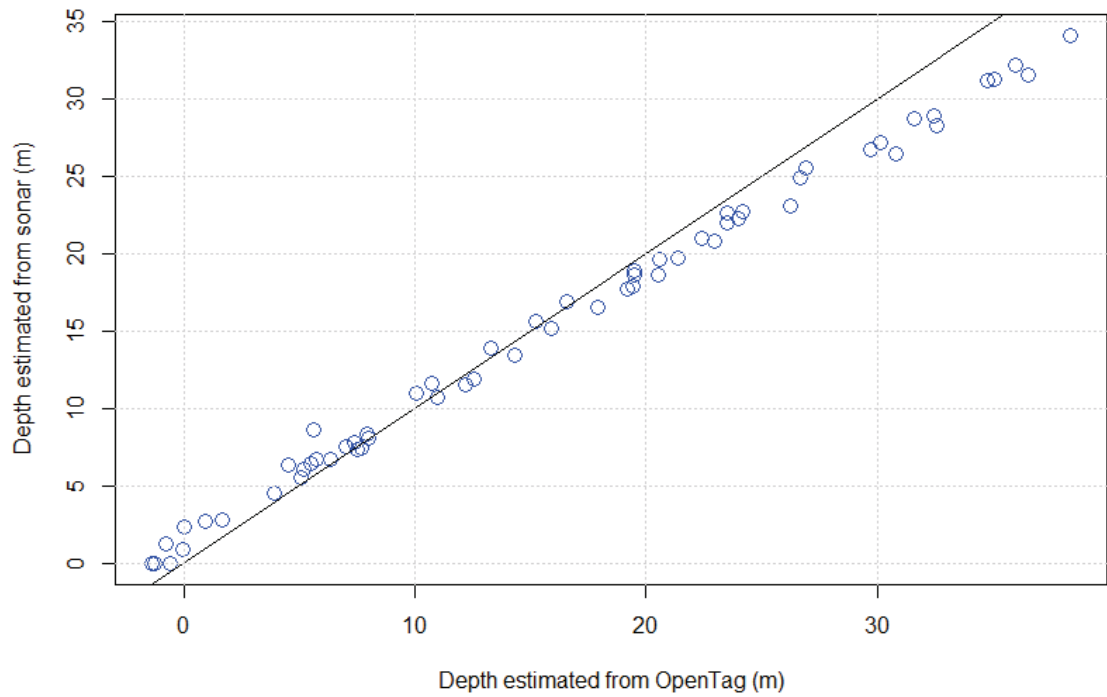
**Figure 27:** Schematic of the acoustic swathes (shown by the blue and green polygons) when the sonars were deployed from the research vessel in a parallel orientation; the sonars were offset by an angle of approximately seven degrees.



**Figure 28:** Example of the data when the sonars were deployed from the research boat in a perpendicular orientation. The figure shows the output from the horizontal sonar on the left and the vertical sonar on the right; two seals can be seen as temporally persistent, highly localised pattern of high intensity pixels in the sonar images.

The results of the calibration using the perpendicular dual sonars showed that the depth of the grey seal carcass could be relatively accurately measured as a distance from the sea surface. At ranges of between 15 and 42 m and for depths of between 0 and 34 m, the errors ranged from -3.0 to +4.9 m with a mean error of +0.8 m and a mean absolute error of 1.6 m (Figure 29).



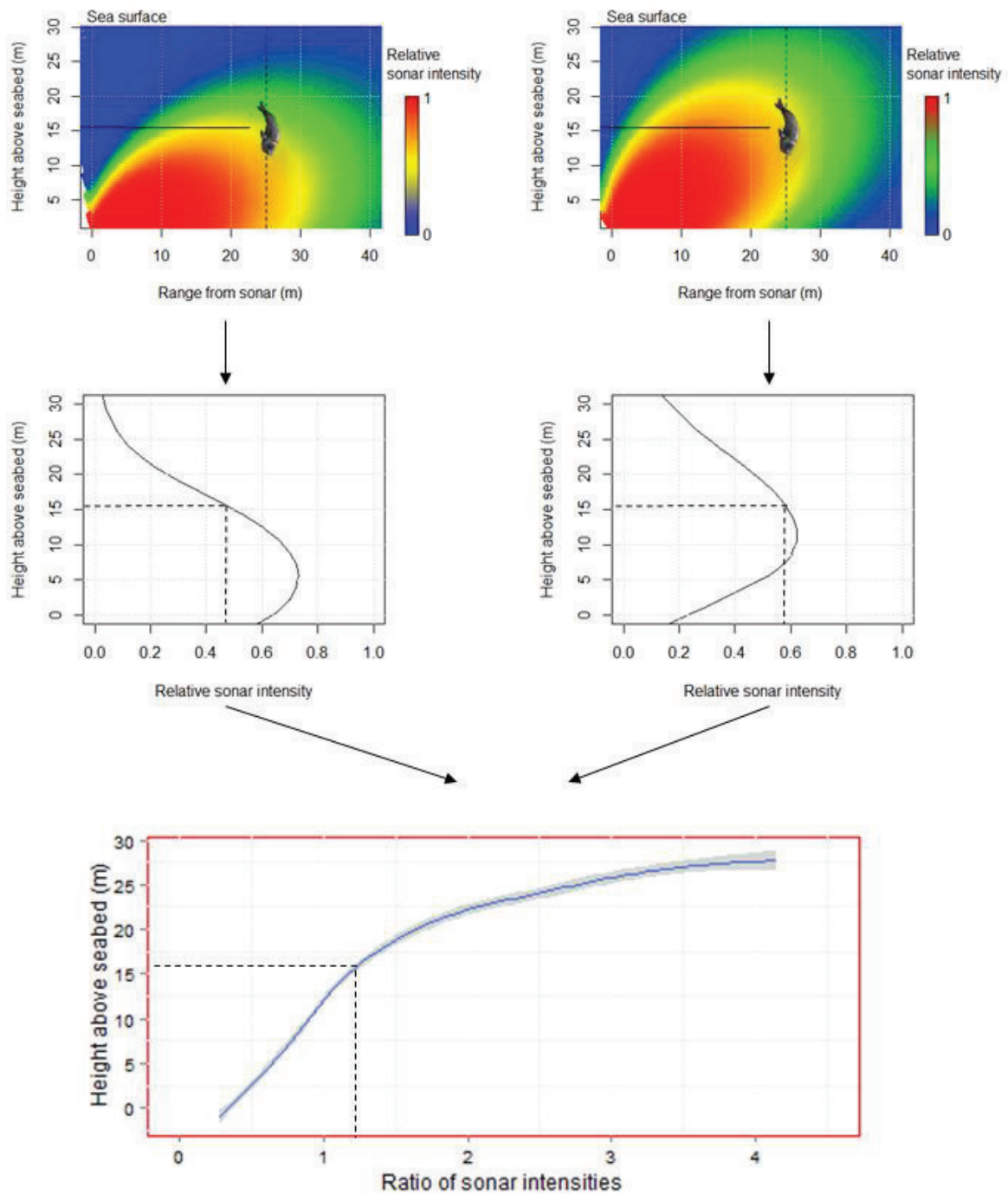


**Figure 29:** The upper panel shows the measured depths (using an OpenTag depth logger) of a grey seal carcass raised and lowered through the swathes of two 720 kHz multibeam imaging sonars plotted against the depths measured on the vertically orientated sonar; the diagonal line represents values where  $y=x$ . The lower panel is a histogram of the errors in depth estimation using the perpendicular sonars; errors ranged from -3.0 to +4.9 m with a mean error of +0.8 m (vertical dashed line) and a mean absolute error of 1.6 m.

### 6.1.2. Parallel Orientation Technique

A second approach to measuring the 3D locations of seals underwater was to mount both the sonars in the horizontal plane, but to offset one of them vertically such that there was a region of the water column where the sonar swathes overlapped (Figure 27).

This approach is based on the concept that if a multi-beam sonar is orientated horizontally, for a given range, the measured intensity of a seal will be at its maximum when it is located at the vertical apex (centre) of the beam; this will decrease as the seal moves vertically (up or down) away from the centre until it is no longer imaged by the sonar. Therefore, as a seal dives vertically down through the swathe of a multi-beam, the intensity of the seal measured on the sonar increases to a maximum as the seal passes the apex before declining as it dives further down through the beam. Given this, if two sonars are orientated horizontally but offset vertically, a seal diving down through each of the swathes will show this pattern of intensity on each respective sonar. However, at any particular depth, there will be a difference in intensity of the seal measured on each sonar as a result of the vertical offset between the sonars; by measuring the ratio of intensities between each of the sonars ( $\text{Sonar 1 intensity} / \text{Sonar 2 intensity}$ ) it is possible to estimate the depth of the diving seal. A worked example of this is shown in Figure 30 and see Appendix B for further details.



**Figure 30:** A worked example of the approach to calculate the depth of a seal using two multibeam sonars mounted in a horizontal orientation but offset vertically. The upper figures show the theoretical intensity of a seal measured from sonars located on the seabed and orientated at angles of 10 (left) and 27 degrees (right) upwards from the seabed; the vertical beam pattern was based on measurements of a seal carcass (Appendix B). A simulated dive of a seal down through each of the beams from the sea surface to the seabed at a range of 25 m from the sonars is shown by the dashed line. The middle figures illustrate the theoretical intensity of the seal measured on each of the sonars during this simulated dive (solid line); the dashed lines illustrate an example of the intensity on each sonar (left~0.47, right~0.58) when the seal is located 15 m above the seabed. The lower figure shows the ratio of theoretical intensities between each of the sonars (right sonar intensity/left sonar intensity) during the seal dive with the example ratio (dashed lines: 1.26) when the seal is located 15 m above the seabed.

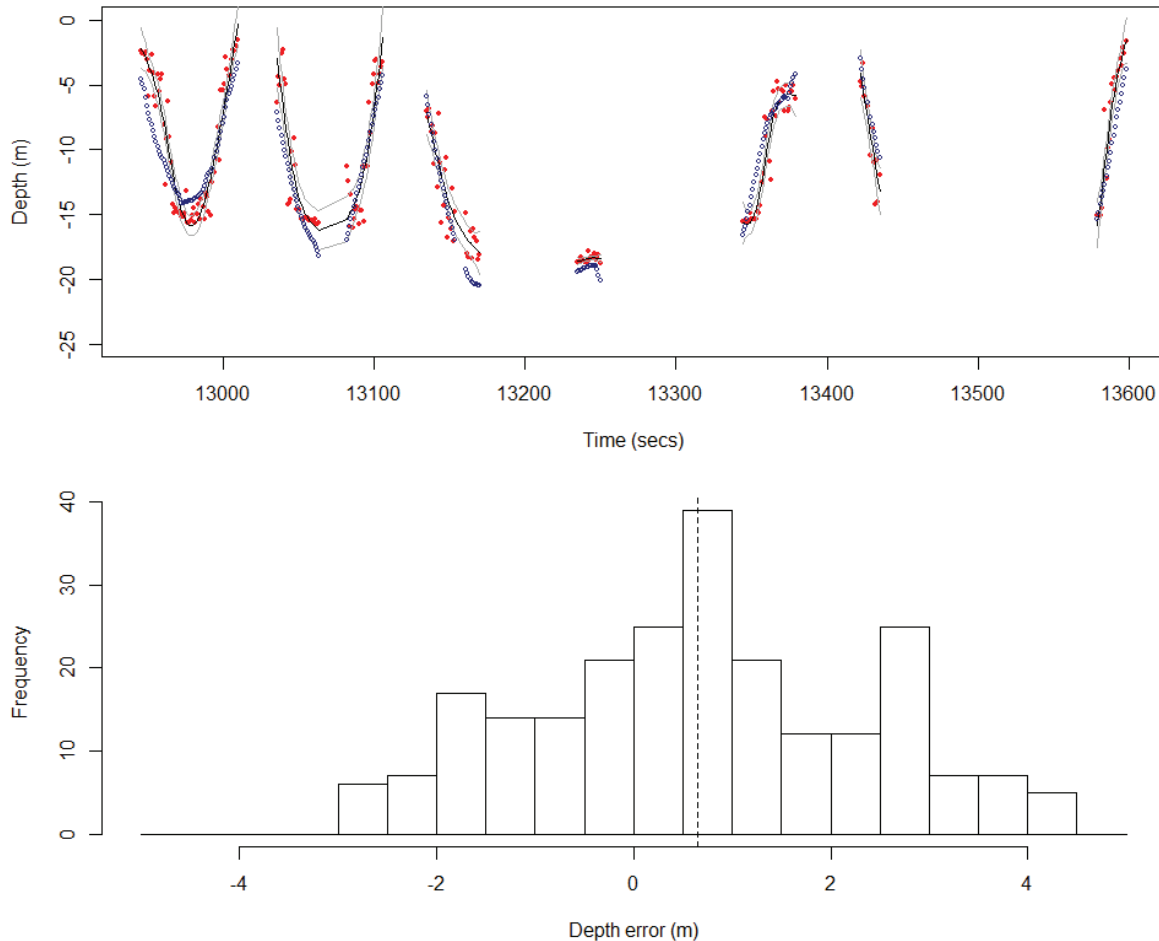
As described in Section 6.1.1, a grey seal carcass with an OpenTag depth logger was used to calibrate this method. The results of this showed that the depth profiles of the grey seal carcass could be accurately plotted by measuring the ratio of intensities between the sonars and smoothing the resulting predicted depths using a cubic spline smoother (see Appendix B for details). At ranges of between 27 and 40 m and for depths of between 0 and 20 m, errors ranged from -2.6 to +4.3 m with a mean error of +0.7 m and a mean absolute error of 1.5 m (Figure 31). It is important to highlight that some of the error in depth estimation (particularly with this offset horizontal technique) will be as a result of vessel movement during data collection, and it is anticipated that the errors will be reduced if the sonars are mounted on a static platform.

When considering the best 3D tracking approach, it is important to consider, not only the magnitude of the errors, but also the pros and cons of the data produced by each. For example, although the perpendicular technique is relatively straightforward compared to the horizontal approach, it is likely that the most effective location to deploy dual sonars in the perpendicular orientation would be upstream or downstream of the turbine. This has inherent limitations in that detectable marine mammal movements will be limited to one side of the turbine which will either be upstream or downstream depending on the direction of the tide. The opposite side of the turbine will always be masked by the turbine itself. The horizontally mounted sonar system is analytically more complex but offers the advantage that it can be located to the side of the turbine which should allow the 3D movements of individual seals to be measured both upstream and downstream of a tidal turbine. It is, therefore, proposed that the offset parallel orientation provides better data to track seals around the operating turbine.

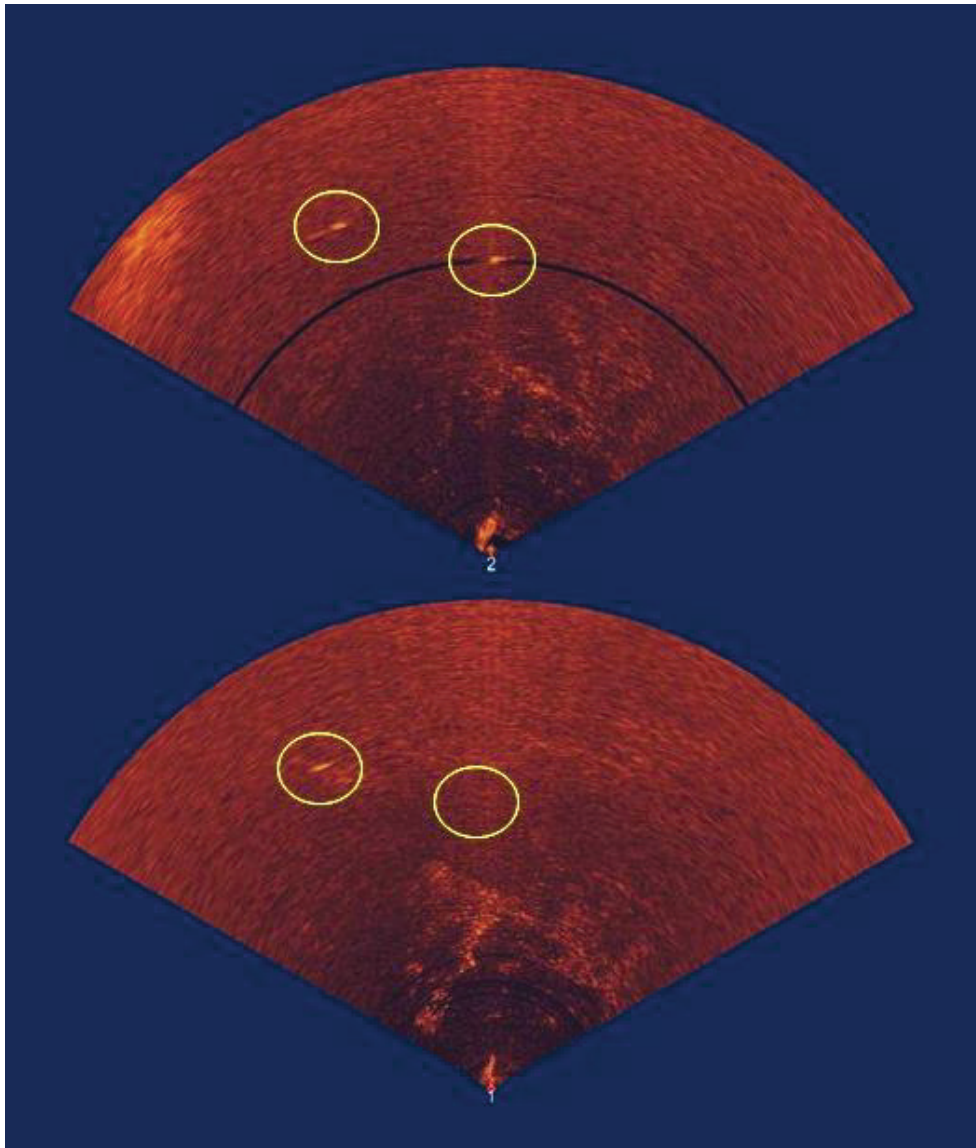
To test the capabilities of the offset parallel orientation to track the 3D movements of live harbour seals in a tidally energetic location, data were collected between 10 and 12 June 2015 in a narrow, tidally energetic channel on the west coast of Scotland that had previously been shown to have high densities of harbour seals (Kyle Rhea: 57°14'8.10"N, 5°39'15.25"W). The channel runs from north to south, is approximately 4 km long, and is 450 m wide at its narrowest point. Water depths within the channel are less than 40 m. Tidal currents within the channel can exceed  $4 \text{ m s}^{-1}$  at peak flow (Wilson *et al.* 2013) with water moving in a general northerly direction during the flood tide and a southerly direction during the ebb.

A total of 56 seals were tracked within Kyle Rhea using the horizontally mounted dual sonars. The vessel manoeuvred around the channel but focused on areas previously identified as being of high-use (Hastie *et al.*, in review). As described

above, the seals were easily identified as highly localised patterns of temporally persistent, high intensity pixels in the sonar images (Figure 32 and Figure 33); however, for the purposes of this analysis, only sonar targets where identification was confirmed by a visual observer on the vessel were used.

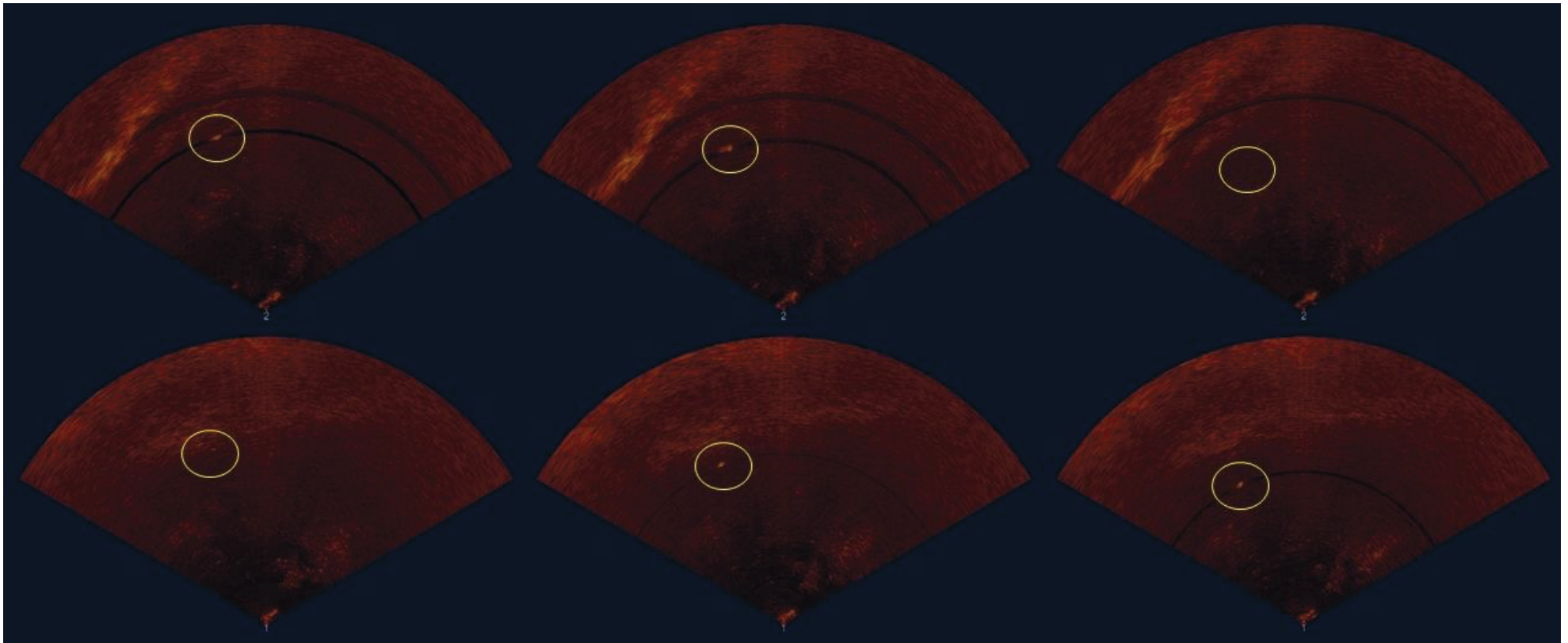


**Figure 31:** The upper panel shows the measured depths (using an OpenTag depth logger: blue points) of a grey seal carcass raised and lowered through the swathes of two 720 kHz multibeam imaging the sonars; the raw predicted depths (using the ratio of intensities approach: red points) and modelled depths (black line) with 95% CIs (grey lines) made using a cubic spline smoother are also shown. The lower panel is a histogram of the errors in depth estimation using the intensity ratio and cubic spline smoother approach; errors ranged from -2.6 to +4.3 with a mean error of +0.7 m and a mean absolute error of 1.5 m.

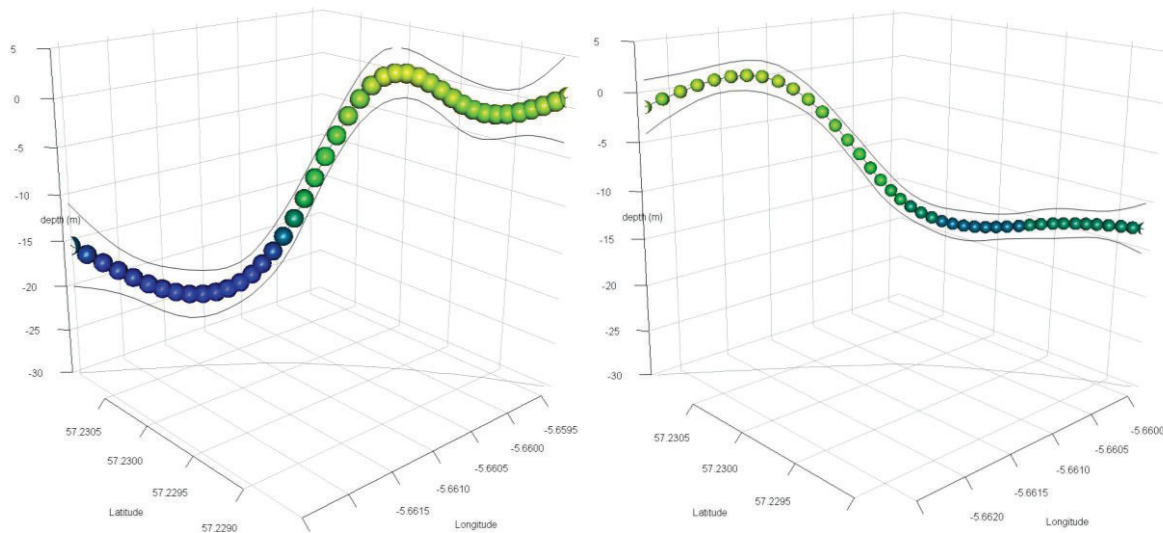


**Figure 32:** Example of a snapshot of sonar data collected within a narrow tidal channel off the west coast of Scotland. Two harbour seals at a range of approximately 30 metres (confirmed through visual observations at the surface) can be seen as distinct targets. In the upper sonar, two seals can be seen whilst only one of them can be seen in the lower sonar; this suggests that one seal is close to the surface whilst the other is mid-water.

The X-Y locations of seals were measured at one second intervals manually using a marker tool in the sonar software. The depth of the seals was estimated using the intensity ratio between each sonar and the method described above. Each seal track was geo-referenced in 3D within the channel using a combination of these X-Y locations and dive depth estimates, together with data from a GPS data logger on the boat and the angle of orientation of the sonars from an OpenTag fixed to the top of the sonar mounting pole (Figure 34).



**Figure 33:** Example of the data over a period of ten seconds when the sonars were deployed from the research boat in an offset parallel orientation. The figure shows the output from the upper sonar at the top and the lower sonar at the bottom at 0 (left), 5 (middle), and 10 (right) seconds. A harbour seal can be seen at a range of approximately 30 m in the upper sonar only at 0 seconds, both sonars at 5 seconds, and the lower sonar only at 10 seconds. Further, there was little movement in the X-Y plane over this time indicating that over the 10 second period the seal dived vertically from the surface down through the water column.



**Figure 34:** Examples of the 3D movements of harbour seals tracked underwater in a tidally energetic channel using the dual sonar system orientated horizontally. The points represent modelled locations at one second intervals, colour coded by depth, and the black lines represent the 95% CI's of the modelled dive depths. The grey line at the base of the plot represents the X-Y track of the seal for illustrative purposes.

As described above, it is proposed that the offset parallel orientation is used to track seals around the operating turbine. Given this, several key pieces of information are required to convert locations in 'sonar-space' to 'turbine-space':

- 1) the relative height of the sonars relative to the turbine nacelle;
  - It is anticipated that this will be obtained via detailed information on the seabed depths and accurate micro-siting of the sonar platform during deployment;
- 2) the rotation of the sonars in the yaw axis;
  - It is anticipated that this will be obtained via accurate micro-siting of the sonar platform during deployment and can potentially be confirmed from sonar data (imaging the turbine) during installation;
- 3) the rotation of the sonars in the pitch and roll axes;
  - It is anticipated that a pan and tilt mechanism with an integrated 3D accelerometer/magnetometer will be used to level the sonars in these axes.

## 6.2. Development of Automated Marine Mammal Classifiers

Previous marine mammal work with the Gemini multi-beam sonars aimed at developing a sonar system to provide a behavioural monitoring tool for marine mammals around marine energy devices (Hastie, 2012). As part of this, sonar data

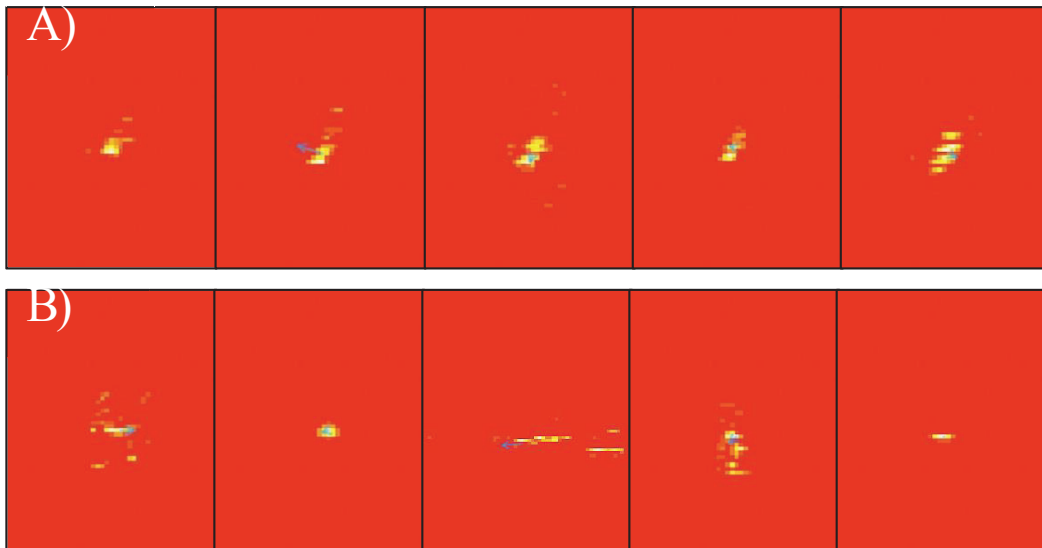


for a range of marine mammal species were collected to develop efficient classification algorithms to reduce data volumes and provide an identification of individual targets. The result of this development program was a user interface for the Gemini multi-beam sonars with an optional module (SeaTec) for the automated detection and tracking of marine mammals. This uses information on size, shape and movement characteristics to determine valid marine mammal targets. However, subsequent validation work with seals has shown that SeaTec is highly conservative in that it is good at detecting seals, but also produces a relatively high number of false positives. This is potentially advantageous from a tidal turbine marine mammal monitoring perspective, where encounters are anticipated to be relatively infrequent; however, it potentially leads to excessive levels of post hoc manual validation of targets. The aim here was, therefore, to improve the data reduction without significantly reducing the probability of detecting marine mammals. This was carried out by refining the marine mammal classifications through a series of analyses of SeaTec data outputs.

As described in Section 6.7.1, Gemini multi-beam sonar data were collected from a seabed mounted platform (HiCUP) deployed in Kyle Rhea at a depth of approximately 15 m on 1 August and retrieved on 5 August 2015. Seals were imaged by the sonar frequently during the data collection periods and confirmed through visual observations of seals from the data collection vessel. The SeaTec detection and tracking software was run post hoc to provide a dataset of seal tracks for the marine mammal classification analyses. All of the visually confirmed seals were detected and tracked (71 tracks) by the pre-development software. Relatively small scale turbulent hydrographic features were also frequently evident in the sonar data at particular states of the tide. These were temporally persistent in the sonar data, often for periods of several tens of seconds. These were frequently detected as potential marine mammals and tracked by the SeaTec software (101 tracks) and were included in the dataset for the classification analyses.

Further information related to each target detection was provided using a version of the SeaTec customized for this analysis to provide a broad range of parameters associated with each detection. This included range from the sonar, kinematic information (e.g. speed and trajectory in the X and Y planes), and detailed information on the size and shape of each detection. The latter was recorded as a series of target intensity matrices which were saved as \*.txt files; these were numeric matrices of the acoustic intensities of the detected target within a defined bounding box (Figure 35).

A total of 161 targets detected by SeaTec were used for this analysis; 65 of these were seals and 96 were non-seal (Figure 35). Non-seal targets were generally small scale turbulent hydrographic features (and items of debris; e.g. seaweed) which appeared as temporally persistent features in the sonar data, often for periods of several tens of seconds.



**Figure 35:** Examples of underwater sonar target images with pixel intensities (blue arrows show the velocity of moving targets). A) sequence of images for one seal over five consecutive frames. B) sample images from five different non-seal targets.

A total of 110 candidate features of the targets were extracted to be used in the classification algorithm. This included the temporal persistence of the target, summary statistics on the movement of the target (distance travelled, angle of movement, proportion of static frames), the shape of the target (length, area, perimeter, and their ratios), and pixel intensity of the targets. Shape features were extracted from the intensity matrices using the R package “raster” (Version 2.4-15). The mean/median, standard deviation, minimum and maximum was computed for each feature. In addition, spectral properties of all features except persistence were derived (spectral density, frequency and amplitude of the first and second peaks). The spectral properties describe changes of the features through time and are extracted from spectrograms generated by Fourier transforms of the features (Cryer and Chan, 2008). For instance, the shape of a seal may change cyclically as it swims; this would appear as one peak frequency in the spectrogram of one or more shape feature. Spectral features were extracted using the R package “stats” (Version 3.2.1). Finally, features with near-zero variance and those that were highly correlated to other features ( $r > 0.9$ ) were filtered out using the R package “caret” (Version 6.0.64). Eighty-three features remained and were scaled prior to use in the analysis.

A Kernel Support Vector Machine, SVM (Hastie *et al.*, 2009) was fitted to the data to classify targets (seal vs non-seal) using the R package “kernlab” (Version 0.9-22). SVMs fit boundaries (support vectors) between classes in 2D space (pairs of features). The number of support vectors can be increased by increasing the parameter “C” (cost of misclassification), and yield a better fit to the data. However, using too many support vectors can result in over-fitting to the data and loss of generality. In order to avoid over-fitting, the parameter “C” was selected by minimising cross-validation error. A 20-fold cross-validation was performed for each parameter value: the data were split in 20 sub-samples, after which the algorithm was fitted using 19 sub-samples and validated using the remaining one. This was repeated 20 times using each sub-sample in turn for validation. The cross-validation error was thus the mean error rate in the 20 validation sub-samples. The algorithm was fitted with parameter “C” of  $10^{(-1 \text{ to } 6)}$ , and 100 times with each parameter value to estimate the uncertainty of the cross-validation error rate. As there were more non-seal targets than seal targets, a balanced sample was generated using the sampling algorithm “SMOTE” (Chawla *et al.*, 2002). A new sample was generated using the R package “unbalanced” (version 2.0) for each of the 100 iterations.

**Table 10**

Fitting the parameter “C” for the kernel Support Vector Machine algorithm. Values for the cross-validation (20-fold) and the number of support vectors are the mean and SD for 100 iterations. The selected model is shown in bold.

Parameter “C”	Cross-validation error		Number of support vectors	
	Mean	(SD)	Mean	(SD)
0.1	0.61	(0.016)	260	(0)
1	0.12	(0.018)	166	(6.4)
10	0.067	(0.014)	119	(6.0)
100	0.059	(0.012)	111	(6.9)
<b>1000</b>	<b>0.057</b>	<b>(0.012)</b>	<b>110</b>	<b>(5.9)</b>
10000	0.059	(0.012)	110	(6.8)
100000	0.059	(0.012)	111	(6.4)
1000000	0.058	(0.012)	112	(6.1)

The algorithm with parameter C = 1000 was selected as the best fitting; it yielded a mean cross-validation error of just under 6% using 110 support vectors (Table 10). The classification accuracy for the entire dataset was 100% for seal targets and 92% for non-seal targets (Table 11), with an overall accuracy of 95% (SD=1.6%).

**Table 11**

Classification of the entire dataset (161 targets) using the fitted kernel Support Vector Machine algorithm. Values in the confusion matrix are mean (SD) frequencies of the 100 iterations.

	<b>Classified Seal</b>	<b>Classified Non-seal</b>
<b>Confirmed seals (N=65)</b>	<b>65 (0)</b>	<b>0 (0)</b>
<b>Non-seal targets (N=96)</b>	<b>7.7 (2.5)</b>	<b>88.3 (2.5)</b>

These results show that it is possible to discriminate between seals and non-seals in Gemini multi-beam sonar data with a relatively high degree of accuracy. The algorithm used correctly classified all the confirmed seal targets but misclassified a small percentage of non-seal targets (~8%) as seals.

If this result holds with future datasets, the analytical approach appears to be an effective means of detecting and classifying seals. However, it is important to highlight that the number of non-seal targets is likely to be far greater than the number of true seals targets in a tidal turbine monitoring application so that the 8% misclassification of non-seal targets could result in a relatively high number of false positive detections. Nevertheless, this approach appears successful in significantly reducing the number of false positive seal targets so that Gemini datasets collected during tidal turbine monitoring can likely be reduced to manageable volumes.

The importance of individual features in the classifier is challenging to extract because kernels are fitted in multi-dimensional space (combinations of features). However, to get a sense of which features are important, the performance of classifiers were compared and fitted to different groups of features: all, only spectral, all except spectral, only pixel intensity, only shape, and only movement (Table 12). This comparison shows that the shape and non-spectral movement features result in the lowest cross validation error.

**Table 12**

Performance of kernel Support Vector Machine classifiers fitted with different subsets of features (mean and SD of 20-fold cross-validation error over 100 iterations). N is the number of features included in each classifier after excluding near-zero variance and highly correlated features. The mean (SD) number of support vectors is also shown to indicate the complexity of the classifier.

Features	N	Cross-validation error		Number of support vectors	
		Mean	(SD)	Mean	(SD)
All	83	0.057	(0.012)	110	(5.9)
Non-spectral	26	0.073	(0.014)	101	(5.5)
Spectral only	57	0.180	(0.013)	129	(7.3)
Pixel intensity	23	0.179	(0.030)	158	(7.9)
Shape	36	0.091	(0.017)	100	(5.8)
Movement	23	0.072	(0.015)	93	(5.0)
- <i>spectral</i>	13	0.242	(0.016)	139	(4.4)
- <i>non-spectral</i>	15	0.086	(0.015)	104	(4.8)

Further development of the classifier (with more validated targets) could potentially increase the accuracy and further reduce the number of false positive detections. While the kernel SVM algorithm yielded a high accuracy in predictions, it uses kernels in multidimensional space, making the results difficult to interpret. A different type of analysis might be more appropriate to narrow down which features are important. Comparison of the classifiers using different subsets of features suggests that simple summary statistics about the movement of targets may be sufficient to classify seals. The next step is to integrate this analytical approach into the SeaTec software such that classification can be run in real time.

### 6.3. Porpoise Click Detection with the Active Sonar

Additional target classification information is potentially available through passive acoustic information received by the Gemini sonars. Specifically, high frequency external sounds (e.g. echo-sounders) are often detected on the Gemini sonars as 'crosstalk' (seen as regular flashes of intensity in the data). Therefore the high frequency clicks of harbour porpoises were tested to investigate whether they could also be detected on the sonars as a potential additional means of validating sonar targets. A high frequency playback system (described in Section 5.2.3) was used to play the echolocation signals of harbour porpoises in the vicinity of the Gemini

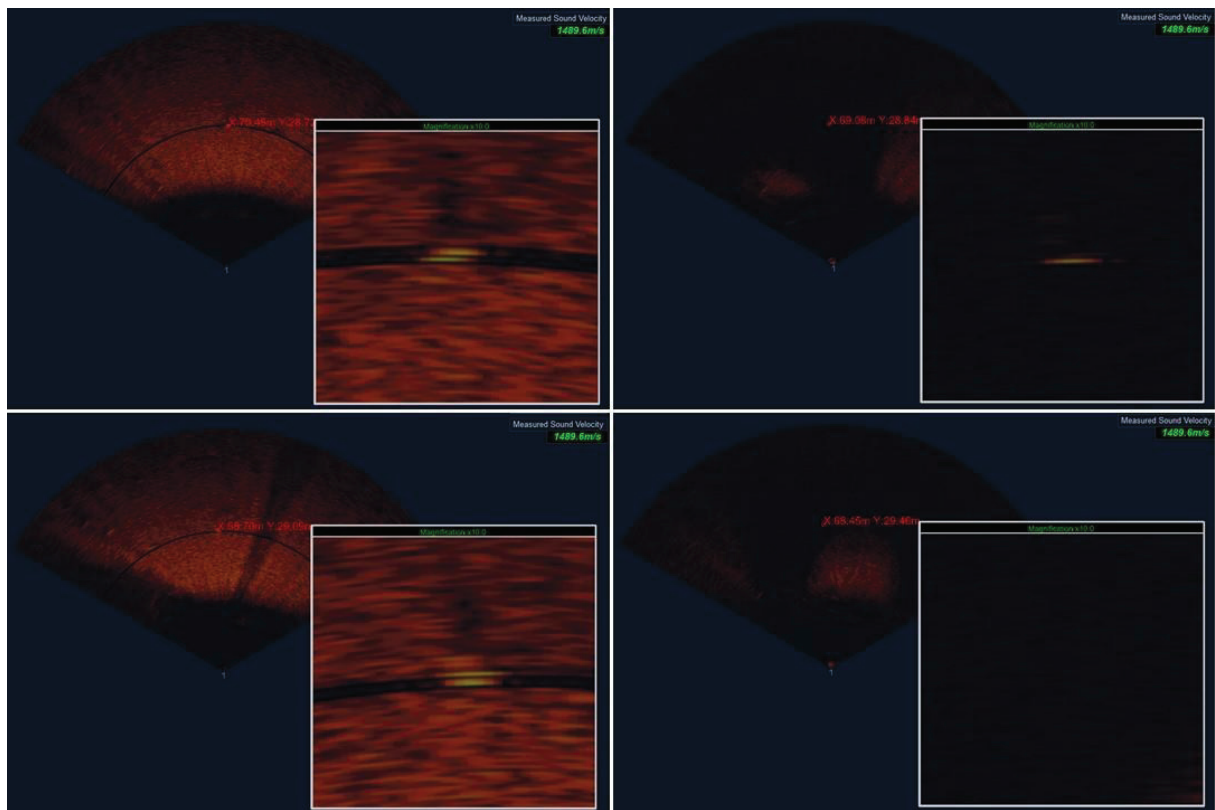
sonars. However, results showed that, even within a few metres, the porpoise clicks were not observable in the sonar data.

#### **6.4. VEMCO Acoustic Tag Detection with Active Sonar**

As above, the acoustic signals produced by VEMCO acoustic tags (Section 5.1.2) had the potential to be detected by the Gemini sonars as 'crosstalk'. Therefore, a VEMCO acoustic tag was deployed in the vicinity of the Gemini sonars to test whether they could be detected by the sonar. However, results showed that, even within a few metres, the acoustic output of the tag was not observable in the sonar data.

#### **6.5. Cowling Tests with Active Sonar**

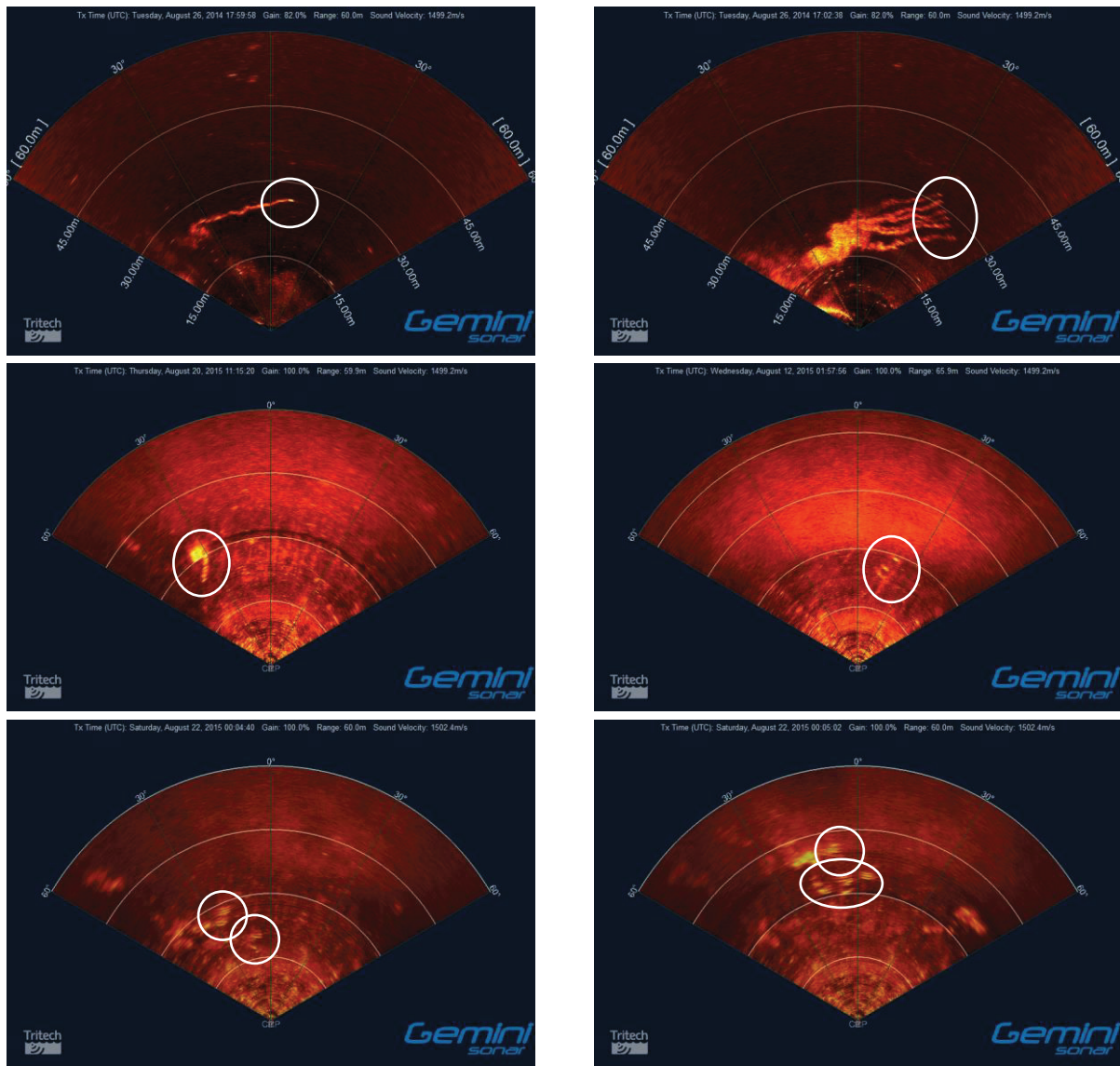
Given the hydro-dynamically aggressive nature of tidal environments, it was deemed prudent to consider providing as much protection to the sonar housing as possible without compromising imaging ability. Therefore, the effects of the addition of an acoustically transparent polyethylene cowling (the same as that proposed for the PAM hydrophones) over the Gemini sonars was tested to see if there were any effects on the imaging capabilities of the sonar. A series of detection tests were carried out using a target (air filled bottle) deployed two metres below the inflatable boat at a range of approximately 30 m from the sonar. The polyethylene cowling was then placed over the sonar and the images of the target compared. Results showed that in each case, there was an appreciable decrease in the target intensities with the addition of the cowling (Figure 36). This suggests that imaging marine mammals is likely to be affected by the addition of a cowling using this material. Given these results and through further discussions with sonar engineers it is suggested that any additional protection provided to the Gemini sonar units (in the form of a cowling or frame) should not cover the transmit or receiver transducers.



**Figure 36:** The effects of a polyethylene cowling on the imaging capabilities of the Gemini sonar. The figure show the magnified images of a target deployed approximately 30 metres from the sonar without (left panels) and with (right panels) the cowling placed over the sonar.

## 6.6. Imaging Capabilities of Other Species with Active Sonar

In addition to the data collection of seals described above, data for a range of other species were collected opportunistically during the study. This included 1) harbour porpoises; 2) bottlenose dolphins; 3) razorbills (*Alca torda*), which are relatively small ( $\approx 0.25\text{m}$  in length), highly mobile targets, that had distinctive trails of turbulence or bubbles streaming behind them; 4) Northern gannets characterised by a distinctive area of turbulence or bubbles (where the bird entered the water) and a trail of turbulence or bubbles leading away from it, and 5) a number of unidentified fish species. These were each confirmed through a combination of visual observations (species 2, 3, 4 and 5) and passive acoustic monitoring (species 1 and 2). Active sonar images for these other species, except the unidentified fish, are shown in Figure 37.



**Figure 37:** Images of other species detected using the Gemini 720id multi-beam sonar. The species are razorbills (upper left and upper right), a diving Northern gannet (mid left), harbour porpoises (mid right), and bottlenose dolphins (lower left and lower right). Each sonar swathe extends to a distance of 60 m.

## 6.7. Integrating Tracking Sensors on Seabed Mounted Platforms

### 6.7.1. Sonar HiCUP Deployment A – Imaging Marine Mammals in a Tidal Channel

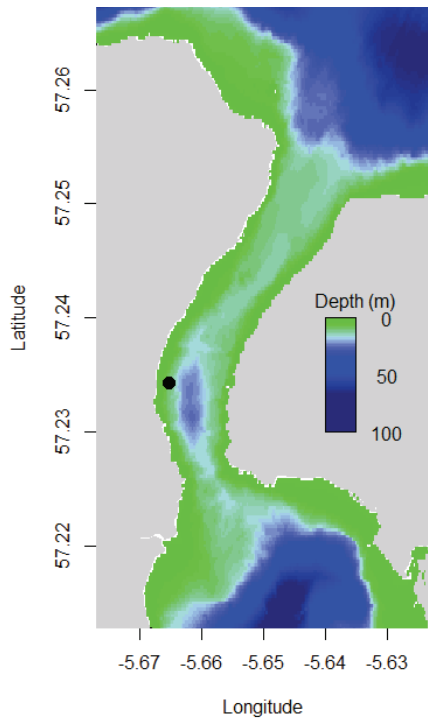
A single HiCUP with dual Gemini 720 kHz multi-beam sonars mounted in a parallel horizontal offset orientation (as described in Section 6.1.2) on a custom built manual pan and tilt mechanism (to control the pitch and roll axes), was deployed in Kyle Rhea in August 2015 (Figure 38). The primary aims of this deployment were to:



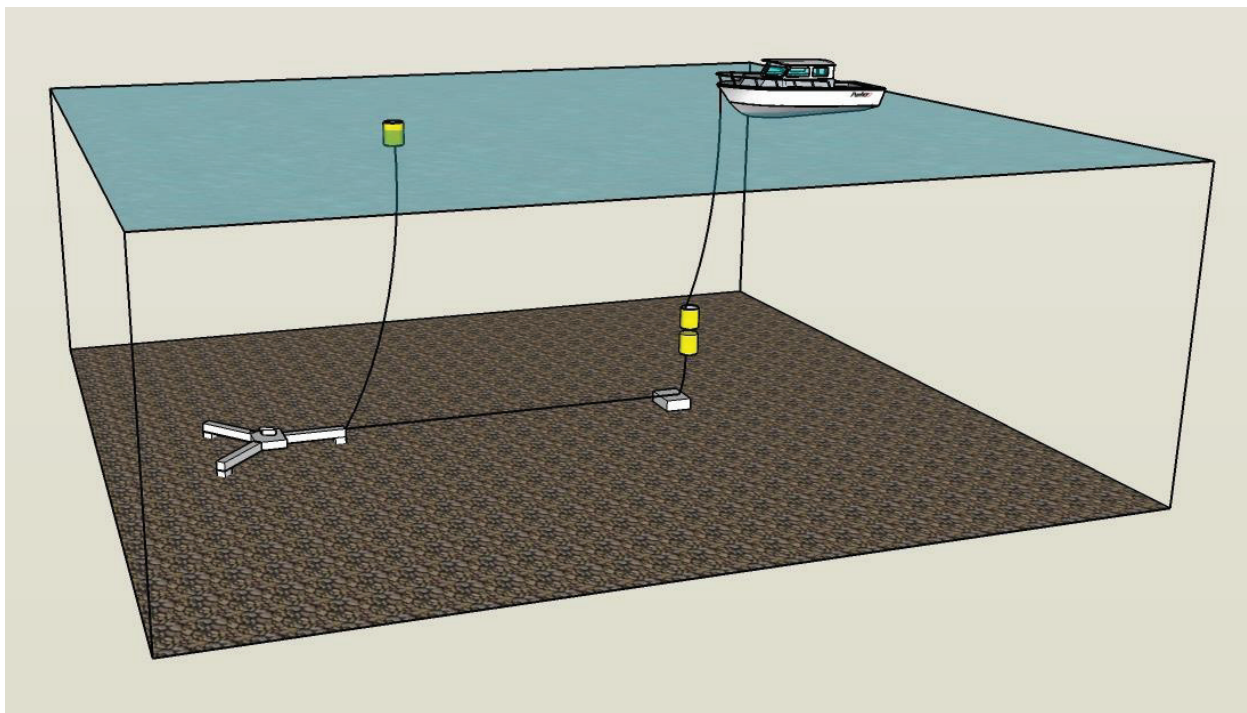
1. Investigate the imaging capabilities of the sonars from a seabed mounted perspective (investigate the effects of tidally induced turbulence on the sonar data);
2. Collect data to develop and validate the marine mammal algorithms (sonar data in combination with visual observations of marine mammals);
3. Collect data to validate 3D marine mammal tracking from a seabed mounted perspective.

The Sonar HiCUP was attached to a small surface marker buoy so that its location could be determined during data collection purposes. A secondary one ton anchor which was located approximately 30 m inshore from the HiCUP, was connected via a poly-steel rope riser to a mooring buoy at the surface (Figure 39) where a 7.5 m aluminium vessel could be moored to collect data. The sonars were connected to a 150 m extension cable with wet-mate terminations at each end and loosely attached to the secondary anchor and riser; these could be connected to the topside electronics of the sonar (Gemini 72V VDSL Adapter) on the vessel for data collection. The Sonar HiCUP was deployed from 1 to 5 August, 2015, on the seabed (rocky with small boulders) towards the western shore of Kyle Rhea at a depth of approximately 15 m (above Admiralty chart datum) using the survey vessel MV *Toohey*. A diver manually adjusted the pan and tilt immediately after deployment to ensure the sonars were level (Figure 40). For deployment at the tidal turbine site, it is anticipated that a pan and tilt mechanism will be remotely controlled rather than requiring a diver or ROV to manually adjust.

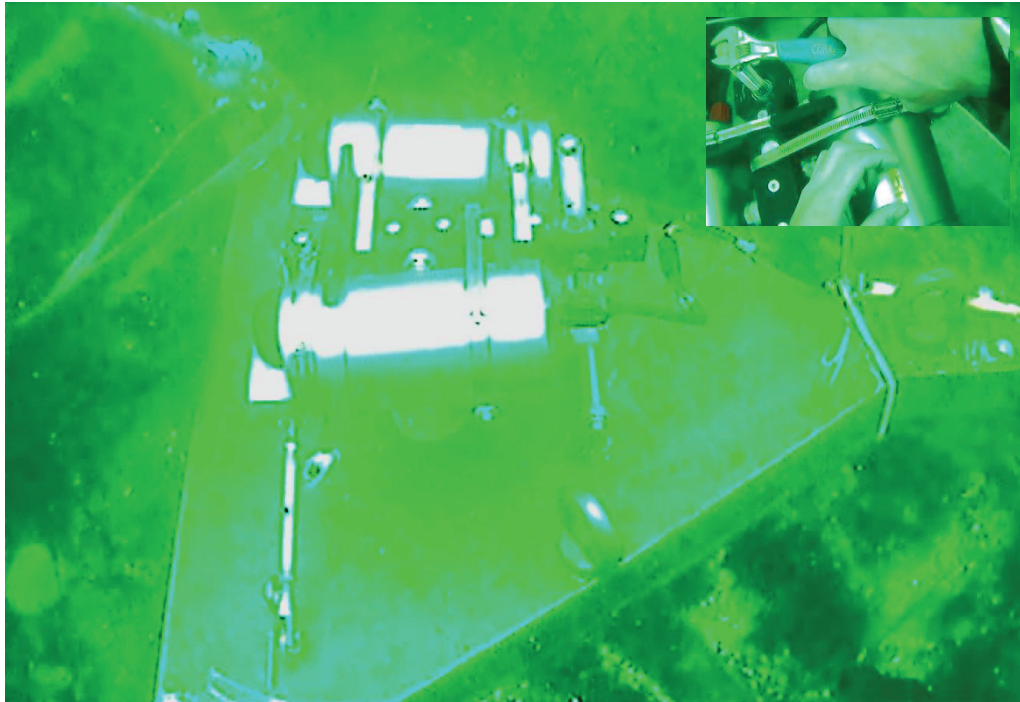
The data collection vessel was moored on the buoy and data were collected during daylight flood tides over this period (seals are most active on the flood tide in this area). Visual observations of seals (and other species) at the surface were also made from the vessel to provide a validation of sonar targets. Throughout these periods, the sonar system proved to be highly reliable and data were collected continuously throughout the monitoring periods. However, as a result of water ingress into one of the subsea connectors, only one of the two sonars was operational during this deployment and unfortunately this precluded the validation of the 3D marine mammal tracking techniques from a seabed mounted perspective. The leak was rectified for the subsequent Sound of Sleat deployment. Data were collected over most of the flood tide period; however, at peak flow ( $>3 \text{ ms}^{-1}$ ) difficulties associated with maintaining the vessel on the mooring in the high current meant that there were short breaks (around 90 minutes) in monitoring over these periods. A total of 76 GB of sonar data were collected during these periods.



**Figure 38:** Hi Current Underwater Platform (HiCUP) with dual sonar configuration in Kyle Rhea. The left panel shows the location of the HiCUP in the channel and the right panel shows it being deployed from the survey vessel.



**Figure 39:** Schematic of the sonar HiCUP mooring deployed in Kyle Rhea showing seabed mounted HiCUP, the secondary anchor, the small HiCUP locating surface buoy, and the data collection vessel.

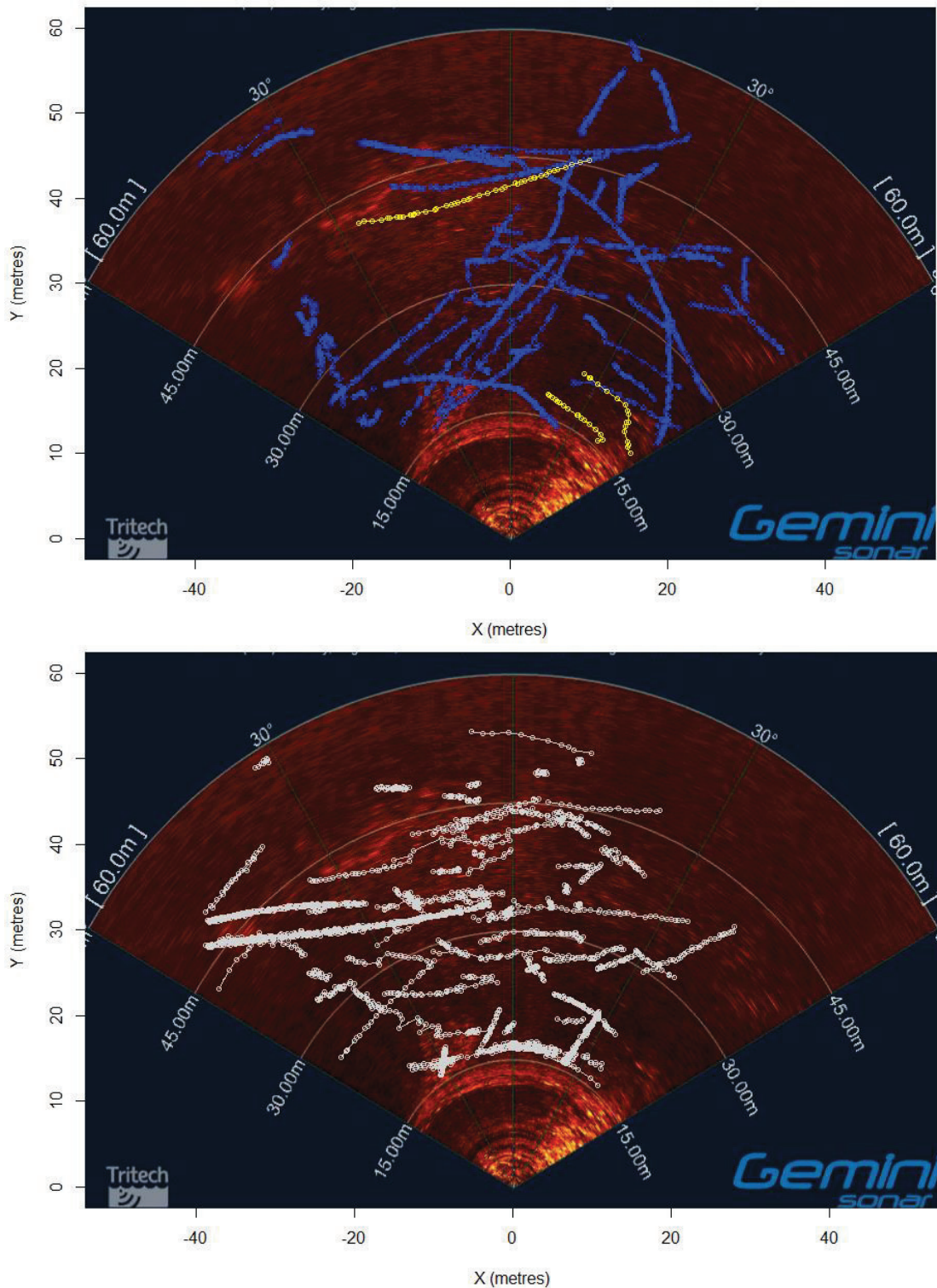


**Figure 40:** Image from the diver helmet mounted camera showing the dual sonars deployed on the HiCUP during installation in Kyle Rhea (main) and the diver adjusting the manual pan and tilt mechanism (inset) to level the system.

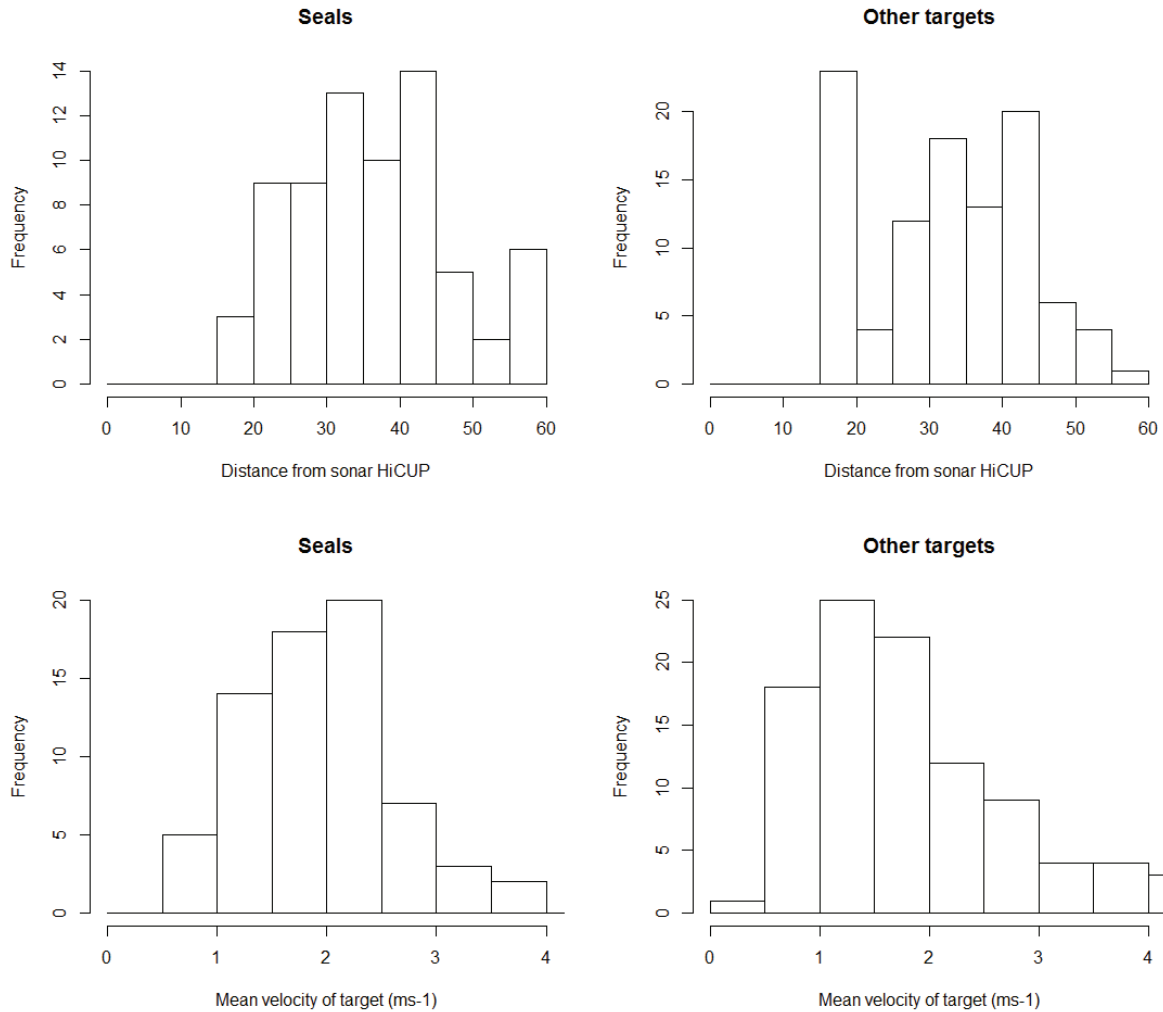
Seals were sighted frequently during the data collection periods in Kyle Rhea and these were also imaged by the sonar. The pre-algorithm development detection and tracking software (SeaTec) was run post hoc to provide a dataset of seals for the marine mammal classification analyses. All of the visually confirmed seals were detected and tracked (71 tracks) by the pre-development software.

Relatively small scale turbulent hydrographic features were also frequently evident in the sonar data at particular states of the tide (Figure 41). These were temporally persistent in the sonar data, often for periods of several tens of seconds. Although these did not appear to markedly influence probability of imaging seals, they (and other small items of debris; e.g. seaweed) were frequently detected and tracked by the SeaTec software (101 tracks). These were included in the dataset for the classification analyses.

Mean distance of confirmed seals from the sonar HiCUP ranged from 15.3 to 59.8 m and peaked between 40 and 45 m (Figure 42). The mean distance of other targets ranged from 16.1 to 58.5 m and peaked between 15 and 20 m. The mean velocity of confirmed seals ranged from 0.6 to 4.7  $\text{ms}^{-1}$  and peaked between 2 and 2.5  $\text{ms}^{-1}$ . The mean velocity of other targets ranged from 0.3 to 11.3  $\text{ms}^{-1}$  and peaked between 1 and 1.5  $\text{ms}^{-1}$ .



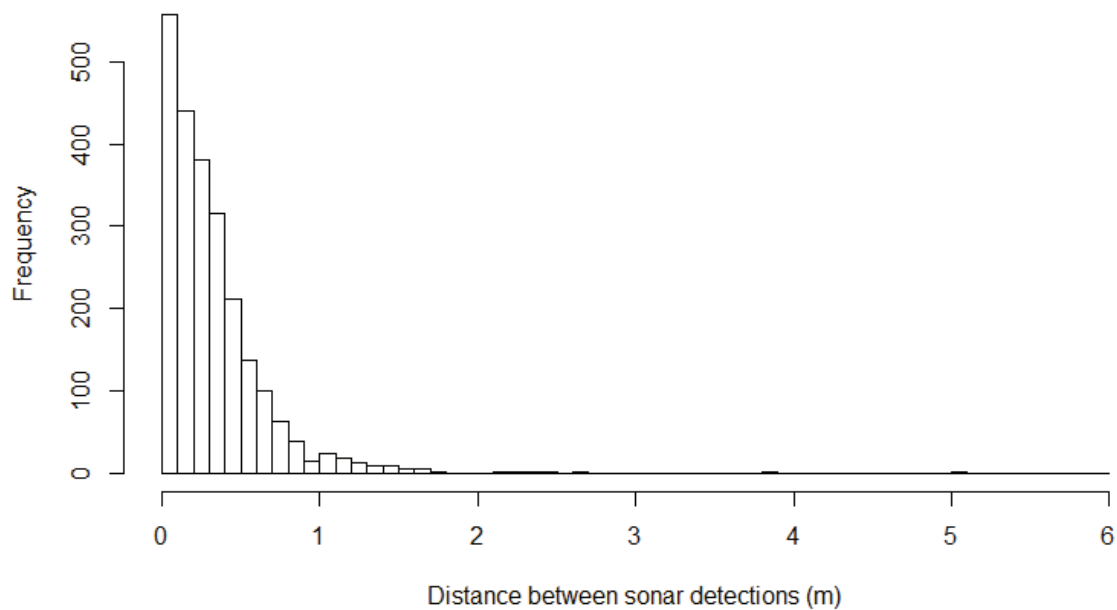
**Figure 41:** The X-Y tracks of a series of targets detected during the deployment of the multi-beam sonar on the HiCUP in Kyle Rhea. Each panel shows the X-Y locations of targets that were automatically detected and tracked using the SeaTec detection software. The upper panel shows the tracks of targets that were confirmed as seals (blue points) and harbour porpoises (yellow points) through visual observations of animals made from the boat, and the lower panel shows other targets that were likely to be turbulence or items of debris (grey points).



**Figure 42:** Distributions of the mean distances of confirmed seals and unidentified targets from the sonar HiCUP (upper) and the mean velocities (lower) of confirmed seals and other targets.

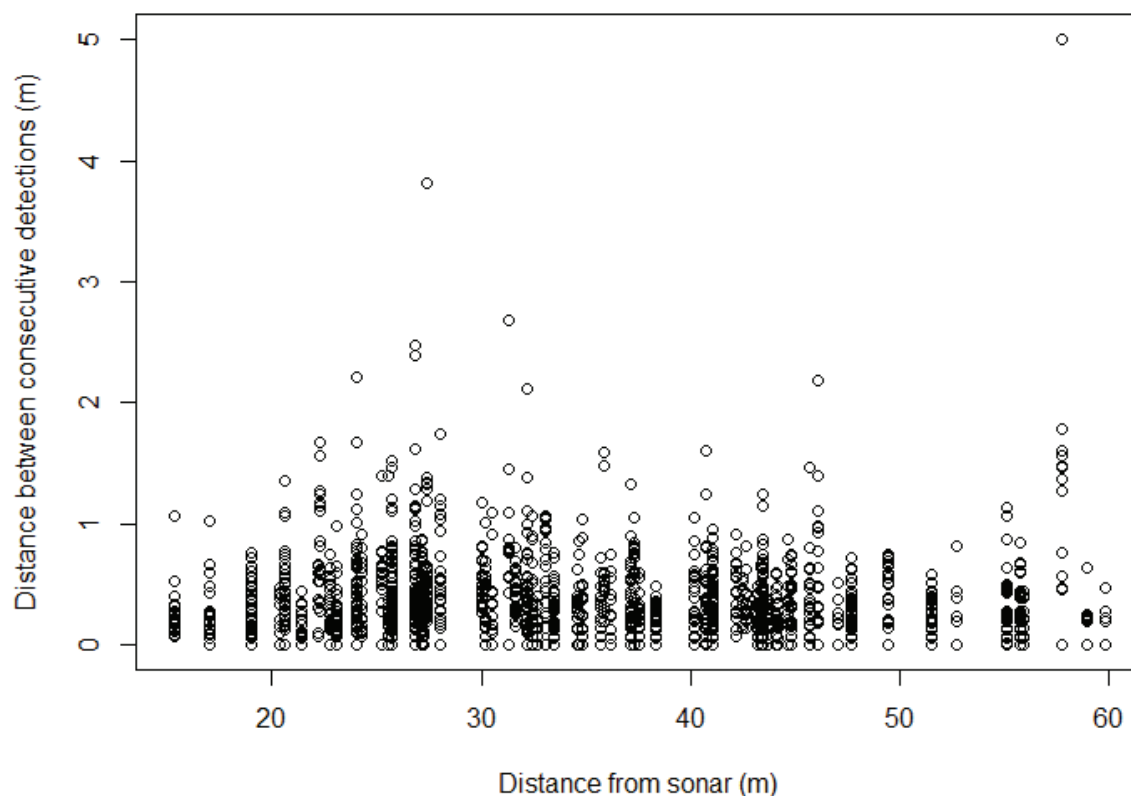
To determine whether the tracks of seals produced by the detection and tracking software are at sufficient temporal and spatial granularity to measure the ‘fine scale’ movement behaviour of seals in close proximity to tidal turbines, the time (seconds) and distance (metres) between consecutive detections of seals in the X-Y plane was determined. Results showed that the majority (99.9%) of consecutive detections of seals within a track were less than or equal to one second apart and all were less than two seconds apart. The distance between consecutive detections of seals within a track was generally low; the majority (81%) of consecutive detections were less than 0.5 metres apart and 95% of all consecutive detections were less than 0.9 metres apart (Figure 43). Furthermore, this spatial resolution appeared to be relatively consistent, independent of the distance of the tracked seals from the sonar (Figure 44). This suggests that using the automated detection software to track

seals in tidal currents up to approximately  $3 \text{ ms}^{-1}$  allows their movement behaviour in the X-Y plane to be measured with sub-metre spatial resolution.



**Figure 43:** Distribution of the distances (metres) between consecutive sonar detections of seals. The majority (81%) of consecutive detections were less than 0.5 m apart and 95% of all consecutive detections were less than 0.9 m apart.

Perhaps most importantly, this resolution should be considered within the context of detecting collisions using active sonar. This requires information on the 3D location of the seal with sufficient accuracy to confirm that the rotor and seal was in same place at the same time. Although the results in the X-Y plane suggest this would be possible, the errors associated with locating the seal in the vertical plane (mean absolute error = 1.5 m) suggest that although the sonar system should be capable of tracking seals in 3D around the turbine, it will be unlikely to reliably confirm collisions with rotors. However, the combination of the dual sonars with additional sensor technology (video / rotor movement data) is likely to assist in the detection of collisions.

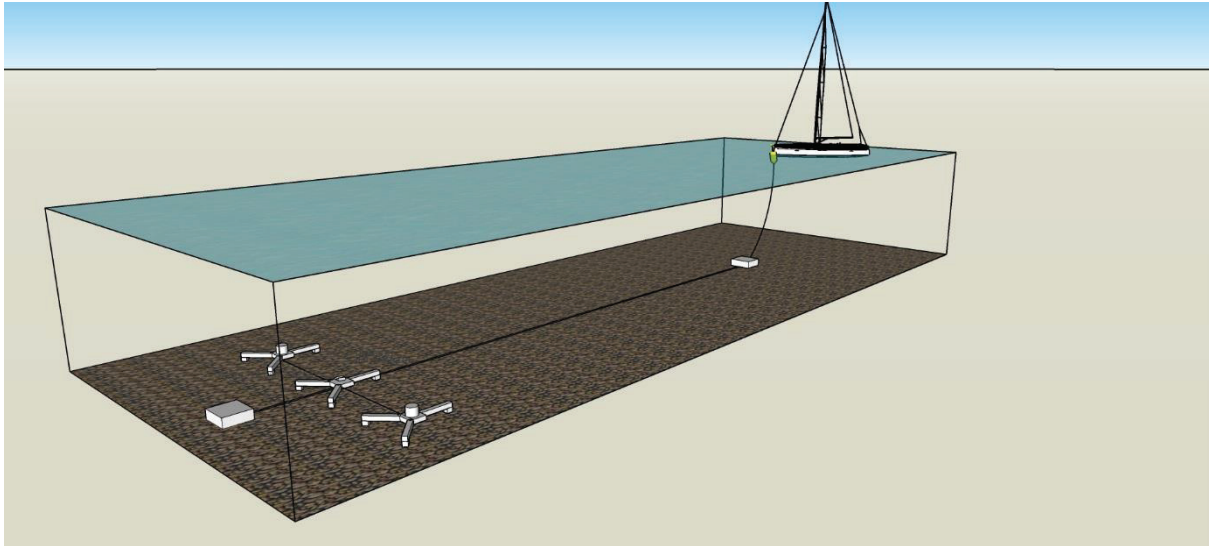


**Figure 44:** The distances (m) between consecutive sonar detections of seals plotted as a function of distance of the seal from the sonar (m). The majority of consecutive detections were less than 1 m apart independent of range from the sonar.

#### 6.7.2. Sonar HiCUP deployment B – long term functionality

A second deployment of the HiCUP with dual Gemini sonars was made in the Sound of Sleat, together with the two PAM HiCUPs (see deployment description in Section 5.1.3). From a sonar development perspective, the primary aims of this deployment were to:

1. Evaluate the operation of the dual Gemini sonars on a fixed seabed mounted platform for a period of weeks;
2. Investigate the imaging capabilities of the dual configuration of sonars from a seabed mounted perspective (evaluate effects of surface turbulence/wave action on the sonar data);
3. Collect additional data to validate the marine mammal algorithms (sonar data in combination with visual observations of marine mammals);
4. Collect data to validate 3D marine mammal tracking.



**Figure 45:** Schematic of the sonar HiCUP mooring deployed in the Sound of Sleat showing seabed mounted sonar and PAM HiCUP, the two secondary anchors, and the research yacht.

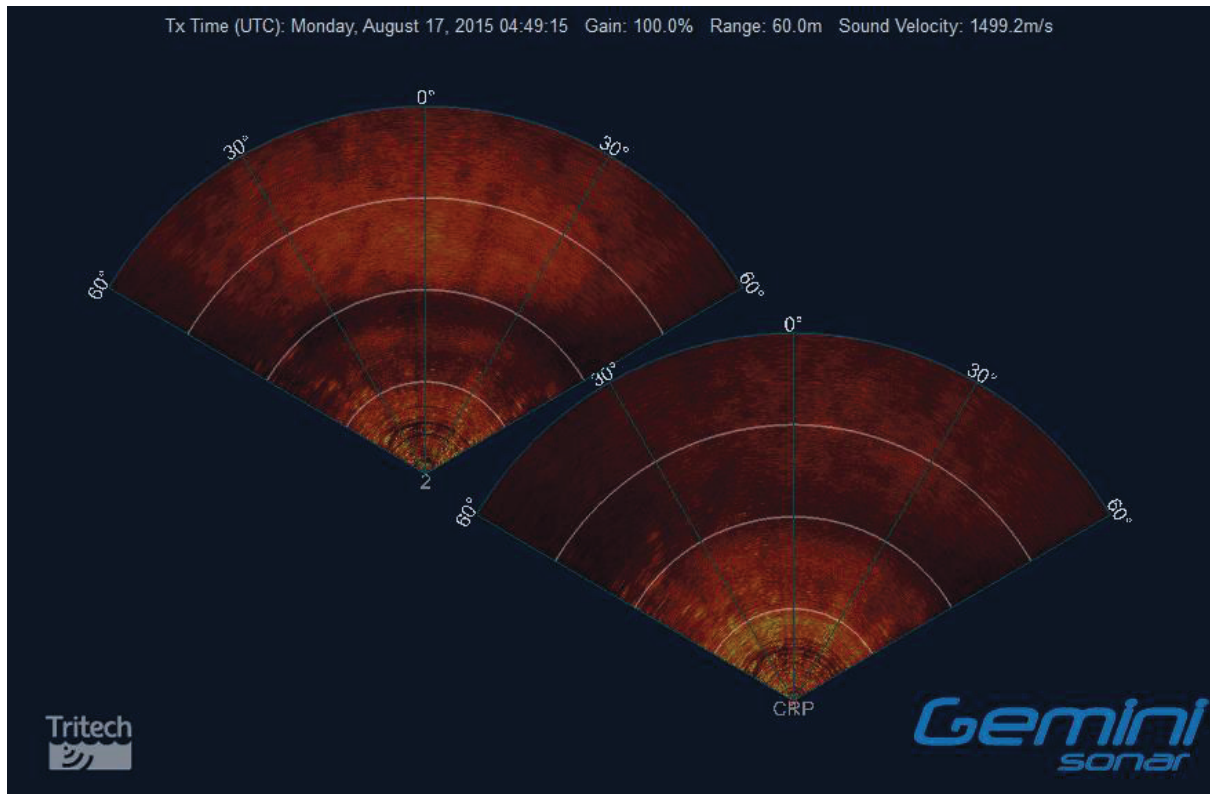
Sonar cables were moored along the seabed from the sonar HiCUP to a moored research vessel where the sonar data were monitored in real time and saved for post hoc analyses (Figure 45). The Trittech software SeaTec was used to monitor the sonar data from each of the Gemini sonars. Furthermore, the software PAMGuard ([www.PAMGuard.org](http://www.PAMGuard.org)) was run to ensure that the internal clock on the laptop was synchronised with GPS time. This was required in order to match any tracks of marine mammals recorded using the sonar with those constructed using the PAM system.

The Gemini sonars operated efficiently throughout the longer term deployment in the Sound of Sleat. The sonars were deployed for a period of 20 days between 5 and 25 August 2015, during which time data were collected on a total of 17 days. The sonar systems proved very reliable with 13.5 TB of sonar data being collected near-continuously over the periods when the research vessel was present. Poor weather intermittently required the research vessel to leave the mooring and disconnect the sonar HiCUP cables, resulting in occasional gaps in data collection. Over this period, no observable biological growth was present on the sonar transducers or housings, although, it should be highlighted that growth at other times of the year may be significantly greater.

Due to the error in deployment location, the sonar HiCUP was deployed in a shallower location (~8 m) than anticipated. It was, therefore, not possible to effectively evaluate the effects of surface turbulence/wave action on the sonar data at the water depths anticipated for deployment around tidal turbines. Furthermore,



the shallow depth precluded meaningful validation of the 3D marine mammal tracking using a seal carcass. Nevertheless, the broad principle that provides the basis for 3D tracking was evident in the data with many targets having differential peak intensities associated with them on each sonar. This, together with the results of the vessel based calibrations, suggests that the 3D tracking techniques tested in Section 6.1 should be readily applicable from sonar data collected on a seabed mounted platform around a tidal turbine.



**Figure 46:** Screenshot of the data from each of the Gemini sonars; the lower right sonar swathe is from sonar that was orientated to be parallel with the seabed and the upper left swathe is from the sonar that was offset vertically upwards by eight degrees.

Observations of marine animals, including marine mammals and seabirds, sighted near the sonar HiCUP clusters were recorded throughout the deployment (Figure 46). Visual observations included harbour porpoises, bottlenose dolphins, grey and harbour seals, and Northern gannets, although, numbers of sightings were generally low and precluded a meaningful validation of the developed marine mammal classification analysis.

Although this deployment period was clearly far shorter than would be envisaged for monitoring around a working tidal turbine, it does highlight that multi-beam sonar can be collected from a seabed mounted platform and monitored in real time via cabling to a remote monitoring station for extended periods.

## 7. Video system

Section 3.3 presents two solutions for video surveillance: nacelle or foundation mounted video camera. The foundation-mounted video is the preferred option since the nacelle-mounted camera will not have sufficient field of view to cover the entire arc of the blades. Delays in obtaining specific details of the nacelle configuration meant that detailed consideration of alternative video configurations was delayed. The current position is that an underwater video consultant has been asked to design a video system that conforms to the following, initial, specification:

- Operating depth 40 m
- Field of view 190 degrees
- Frame rate Min 5fps
- Sensor Low light, 5 Megapixel
- Anti-fouling Intermittent UV LED illumination of optical port. Longevity > one year
- Data IP addressable – likely bandwidth requirement  $\leq$  16 mbps per camera
- Electrical 24 V, 500 mA (1 A intermittent for LEDs)

This large 190° ‘fish-eye’ field of view will permit the detections of targets in the general vicinity of the blades. The solid-state ultraviolet LED anti-fouling system on the optical port should be more reliable than a mechanical scrubber.

## 8. Discussion

The work described in this report demonstrates how a combination of Active Sonar, Passive Sonar and Video can be configured to provide data to identify and localise marine mammals in the vicinity of a tidal turbine. All three sensor systems provide high bandwidth data, and while it would in principle be possible to create a stand-alone system (similar to FLOWBEC) to collect these data, such a system would have a limited lifetime and could not provide data over the temporal scales required to study interactions between marine life and a turbine over a period of many months. The systems described here are therefore cabled systems, reliant on integration into the turbine infrastructure in order to receive power and to transmit data to shore.

### 8.1. Passive Acoustic Monitoring (PAM)

The PAM system proposed is a multiple array of tetrahedral hydrophone clusters (THCs) capable of three dimensional tracking of harbour porpoises and acoustic tags. Each THC consists of a light frame holding the four hydrophones, mounted within a physically strong but acoustically transparent cowling made of high density polyethylene. Field trials demonstrated that the THCs were reliable and capable of detecting harbour porpoise and bottlenose dolphin clicks. Location accuracy was investigated using trials with an artificial porpoise sound and using simulations. Trials also demonstrated that the spherical cluster design had better timing accuracy than the cylindrical design, which is likely to be a result of a combination of the different shape of the cowling as well as in the spacing of the hydrophones – the domed-spherical cluster had a narrower hydrophone spacing meaning that the signals were less distorted by echoes than the more widely spaced hydrophones in the cylindrical cluster.

The range error in acoustic localisations was generally small (<5 m) out to about 50 m, however, depth error appears to be larger and at least several meters at all ranges. However, due to the issues encountered with the HiCUP placement and the fact that the proposal is to use three, rather than two clusters, the results will underestimate localisation accuracy of a system installed on an operational turbine. The simulations for a system consisting of three clusters around a turbine structure indicate that localisation accuracy improves in all dimensions, the error in range being < 3 m; depth < 0.7 m and angle < 0.5 degrees at 25 m from the turbine.

While timing accuracy of the VEMCO tag pulses is not as good as it is for porpoise clicks ( $\pm 7.5 \mu\text{s}$  as opposed to  $\pm 5 \mu\text{s}$ ), this has little impact on localisation accuracy at short ranges, and similar levels of accuracy are anticipated as for

porpoises close to the turbine blades. Despite the potential for acoustic tags to provide information from a number of tagged seals in the vicinity of the turbine, consideration must be given to the potential for animals to hear the tags. For example, Stansbury *et al.*, (2015), demonstrated that seals could use signals from 69 kHz acoustic tags to locate fish. The frequency of the tags tested here is 83 kHz and, whilst it is at the upper end of the hearing range for seals, it could still be audible and could potentially affect the seals behaviour.

A number of other hardware and software developments have been made. The PAMGuard software has been modified to allow detection of VEMCO acoustic tags. Work has also gone into developing a data acquisition system capable of processing multiple channels of hydrophone data at a high sample rate. This system is currently capable of processing eight channels of data and further work is required to get it to 12 channels (see Section 8.4.1).

## **8.2. Active Acoustic Monitoring (AAM)**

Significant progress has been made in relation to the development of active sonar as a technique for detecting and tracking marine mammals around tidal turbines. Previous deployments with a single multi-beam sonar only allowed the x, y positions of targets to be determined. This project has developed and tested a technique to track marine mammals in 3D in a tidally energetic environment. Two different sonar configurations were tested for this and it was concluded that an overlapping parallel horizontal orientation provided the best results. By measuring ratio of the sonar intensity of a target imaged simultaneously on two sonars arranged in this way, the depth of the animal can be calculated. The error in depth estimated in this way is approximately 1.5 m (although this error may be less when the sonars are mounted on a static platform).

An efficient algorithm for the classification of marine mammals in multi-beam sonar data has been developed which is capable of reducing the high false positive rate reported in previous studies (Hastie, 2012). Cross-validation of the resulting algorithm estimated a cross validation error of 6%. All confirmed seals were correctly classified using the algorithm, while only 8% of non-seal targets were classified as seals. Given the 8% rate of false positives and the number of likely non seal targets in any dataset collected in a tidal environment, relative to the number of real seal targets this still may represent a reasonable number of false positive detections. If this result holds with future datasets, the analytical approach developed will be an effective means of detecting and classifying seals.

The bottom mounted configuration likely to be used in the turbine site deployment has also been successfully tested in a tidally energetic environment and it has been demonstrated that tracking and detection algorithms can still detect marine mammals against a backdrop of additional background noise and surface clutter.

### **8.3. Video Surveillance**

It is expected that video surveillance will provide, during periods of daylight and good visibility, fine scale details of encounters detected by the PAM and AAM systems. However, the uncertainty surrounding the video systems employed by the developer have delayed testing of any video systems in the field. In January 2016 it became evident from the developer that only a foundation mounted system would be feasible. Commissioning of a suitable camera, housing and anti-biofouling system are currently on-going.

### **8.4. Proposed tidal turbine site deployment – MeyGen**

At an early stage in this project, it became apparent that MeyGen's Inner Sound tidal array would be the first commercial array deployment in Scottish waters, therefore, a decision was made to work towards the deployment of the equipment developed as part of this project at that site. The timing of the deployment of turbines at the site is beyond the timeline for the current project so phase two of the SGDS project will cover the actual deployment and commissioning of equipment and the collection and analysis of data.

A number of developments are required to enable progression to this second phase. This section of the report summarises the progress to date towards this objective and outlines the remaining tasks. Consideration is given to hardware and software developments required as well as to processes for data collection, processing and storage.

MeyGen have agreed to provide a cable (power and data) interface to allow connection of an SGDS developed 'instrumentation platform' to one turbine, and discussions are on-going to integrate into a monitoring system that includes other sensors and clarify the alignment of the SGDS objectives (current phase and next phase of SGDS project) with MeyGen consent conditions in terms of data ownership, processed outputs (deliverables to enable consent), contingency in case of monitoring equipment failures, operating durations and equipment ownership.

Phase 1a of the MeyGen Inner Sound deployment consists of three Andritz Hammerfest turbines and a single Atlantis AR1500 turbine. The Atlantis turbine will be instrumented as part of this project, as it was the only turbine with the power and data bandwidth capability for the preferred monitoring equipment. .

#### 8.4.1. PAM

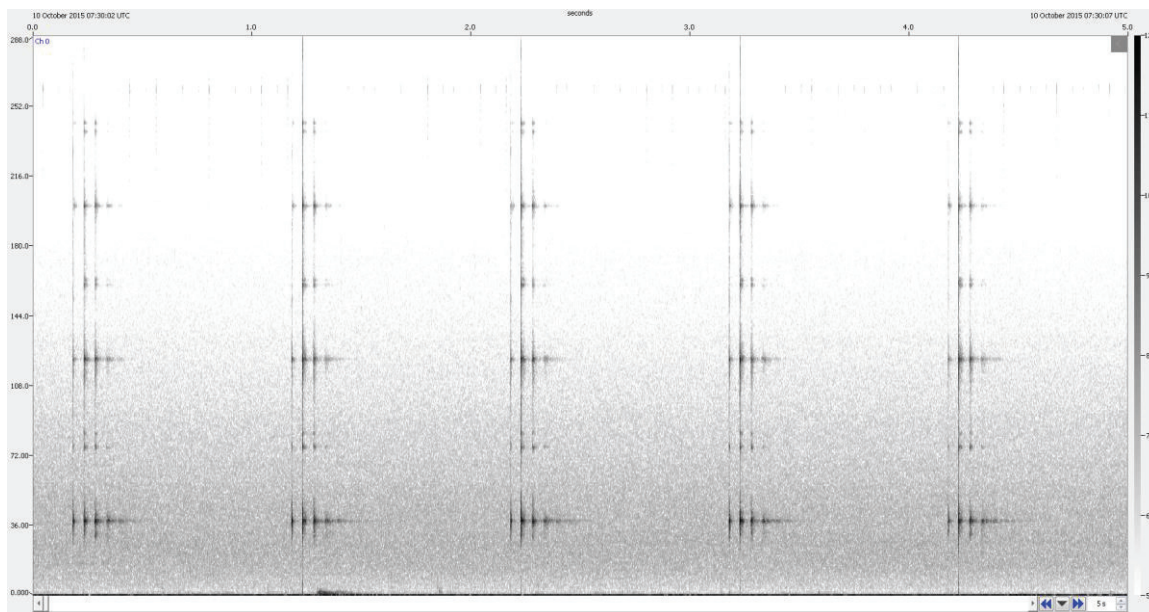
Trials and simulations have shown that the deployment of three THCs will provide accurate tracking around the turbine site. Detection range will ultimately depend on background noise levels in the vicinity of the turbines and the level of any electrical noise from the turbine.

In order to test the performance of the cowlings in a high flow environment, the domed hydrophone cluster was deployed on the FLOWBEC frame for a period of two weeks in October 2015. Data were collected using two SoundTrap recorders, sampling at 576 kHz, one mounted inside the cowling and one outside. Noise was dominated by the EK60 sonar as can clearly be seen in Figure 47. Multiple arrivals of each EK60 ping are visible, separated by 50 ms, which is consistent with multiple surface/bottom echoes in a water depth of around 36 m. At low frequency, during tidal flow, “thumping / flapping” noises could be heard, probably made by loose material on the FLOWBEC frame vibrating in the flow and hitting part of the frame. Examining very short sections of data between EK60 pings indicates spectrum level noise levels within and outside the cowling were broadly similar at different frequencies (Table 13). At the high frequencies of interest, noise increased from 30 to 57 dB re 1  $\mu\text{Pa}/\sqrt{\text{Hz}}$  at times of high flow. It is not possible to tell if the elevated noise is from flow over the FLOWBEC frame or over the cowling. The fact that noise levels were very similar for the internal and the external SoundTraps perhaps indicates that the dominant source of noise is independent of those parts of the structure. The consequences of the higher noise level for monitoring would not in themselves be too severe. For a 57 dB re 1  $\mu\text{Pa}/\sqrt{\text{Hz}}$  noise level over the entire 70-150 kHz detection band, the broad band noise level would be around 107 dB re 1  $\mu\text{Pa}$ . This would be expected to give a detection range of harbour porpoises in excess of 200 m.

**Table 13**

Spectrum level noise levels measured between EK60 pulses at low and high flow for a cowling installed on the FLOWBEC platform in October 2015. Units are dB re 1  $\mu\text{Pa}/\sqrt{\text{Hz}}$ .

	Low Flow (2015-10-10 04:10 UTC)		High Flow (2015-10-10 07:10 UTC)	
	10 KHZ	130 KHZ	10 KHZ	130 KHZ
<b>Inside Cowling</b>	42	30	72	57
<b>Outside Cowling</b>	38	30	70	57



**Figure 47:** Spectrogram of five seconds of data collected using a SoundTrap recorder mounted on the FLOWBEC frame. Y axis scale in in kHz.

It is also expected that in most circumstances VEMCO tags will be detected out to 100 to 200 m range. Detection ranges of dolphin clicks should be several times greater.

There is currently one domed THC, with a requirement for another two to be built. Although the components are available for the clusters themselves, similar dome shaped polyethylene cowlings will need to be sourced or made as these are not mass produced. These THC units have not been tested in areas of particularly high flow (Sound of Sleet deployment was restricted to relatively low currents). However, the present design, with a small amount of modification, should be robust enough to withstand currents at the MeyGen site in the Pentland Firth.

#### 8.4.1.1. Installation

A number of actions are required prior to installing the PAM system on a turbine. Firstly, the design and manufacturing of the protective cowlings around the hydrophone clusters needs to be finalised in order to provide a cost effective, but robust solution, which can be delivered over a relatively short time frame.

Discussions with MeyGen engineers are taking place to finalise mounting of the PAM system on the turbine and housing of the PAM acquisition system in a suitable dry space.

MeyGen engineers are also considering the type of cabling and connectors to be used between the individual clusters and the central junction box. This may depend on the logistics of installing and mounting the equipment and should wherever possible follow the same standards being used for other turbine cabling. It has been agreed that it will not be possible to access the clusters after deployment for any maintenance or replacement, therefore, it is likely that the cables will be hard wired into the THCs with the cables routed in protective conduits between each THC and the central junction box.

#### 8.4.1.2 Shore Side Processing

As it has been established that the same detectors can be used for both cetacean sounds and the VEMCO tags, shore side processing of the PAM data can take place on a single high specification desktop PC. Data rate from the turbine will be high, so a minimum of a 100Mbps Network connection will be required.

The PAM PC will run the PAMGuard software configured to detect both cetacean clicks and whistles and the VEMCO tags. Clicks will be automatically classified as porpoise, dolphin, VEMCO or noise based on frequency content and duration. The system will also measure ambient noise levels and a separate watchdog program will be used to ensure long term system reliability. The system will have the capability of recording raw audio data, but it should be noted that raw data volumes are extremely high at around a TB per day. Standard practice will, therefore, be to only record short clips of sound around detections, with the possibility of making longer recordings, particularly for diagnosing system performance during commissioning stages. These data will be stored in binary data files which are generally small enough to be transferred between sites via the Internet. These data can be easily summarised on a regular basis in terms of numbers, dates and times of detections for reporting to the regulator or for further analysis. Tracking data will need further post hoc analysis to describe and interpret behaviour (see Section 8.6).



It will be possible to configure a live audio stream from up to two of the 12 hydrophones. It will also be possible to configure an audible alarm in the event of detection of different click types.

Video (probably at a rate of five fps) will also be live streamed to shore side for storage and subsequent inspection when PAM or AAM detect a potential encounter.

#### 8.4.1.3. Data Volume and Management Strategy

Raw data from all 12 hydrophones sampling at 500kS/s will have a total volume of a TB per day. Generally, except during commissioning stages of the monitoring program, storing all of the raw data will not be considered. Binary data files from the detectors and noise monitors may amount to approximately 400 MBs per day (a reduction of 2500:1 compared with the raw data), although this is heavily dependent on how detectors are configured and noise conditions around the turbine. In addition, at least some diagnostic recording will be required, although how much can only be determined in the light of how noisy (i.e. how difficult to interpret) data from the detectors are. Following the initial commissioning period, the system may be set to record raw audio data when animals have been automatically detected. The PAMGuard software also writes operational log files (including any error messages/crash reports) to log files on the system hard drive. Binary data will initially be written to an internal hard drive and backed up daily onto external storage. Assuming sufficient network bandwidth is available, binary and PAMGuard log files data will be uploaded to SMRU on a weekly basis. Larger volumes of data (i.e. recordings) will need to be recovered on hard drives as required. For quality control and preliminary data checking, binary files and system log files will be checked on a weekly basis. More detailed detection confirmation and track analysis will take place on a monthly basis. The proposed data management schedule for PAM data is summarized in Table 14.

**Table 14**  
Proposed data management scheduling for PAM data.

Activity	Data Volume	Location	Timing
Real time detection results saved to hard drive	Approx. 400 MB / day	Internal hard drive	Real Time
PAMGuard system log files	MB's / day	Internal hard drive	Real Time
Backup of detection results and log files	Approx. 400 MB / day	Local external USB drives	Daily
Continuous Recording	1 TB / day	External 4 TB USB hard drives	Real Time (Commissioning only)
Detection triggered recordings	To be determined	External 4 TB USB hard drives	To be determined
Upload of detection and log files via remote access	Approx. 400 MB / day	Remote data recovery to disk drives at SMRU	Weekly
Recovery of recordings	Many TBs	Recovery of hard drives	As required.
Data quality control		SMRU	Weekly
Detection confirmation and tracking		SMRU	Monthly

#### 8.4.1.4 Alarms and SCADA Interface

Various alarms can be configured within the PAMGuard software which can show both visual and audible alarms on the PAM PC and also send RS232 NMEA like information sentences to a remote computer. For example, these could be sent to the central control system and integrated into other system data streams in order to alert the system operator at times when a dedicated PAM operator is not present. How these are configured will require discussion with other engineers developing the controls systems for the turbine and dependent on the monitoring strategy required by MeyGen during operation.

#### 8.4.2. Acoustic Tags

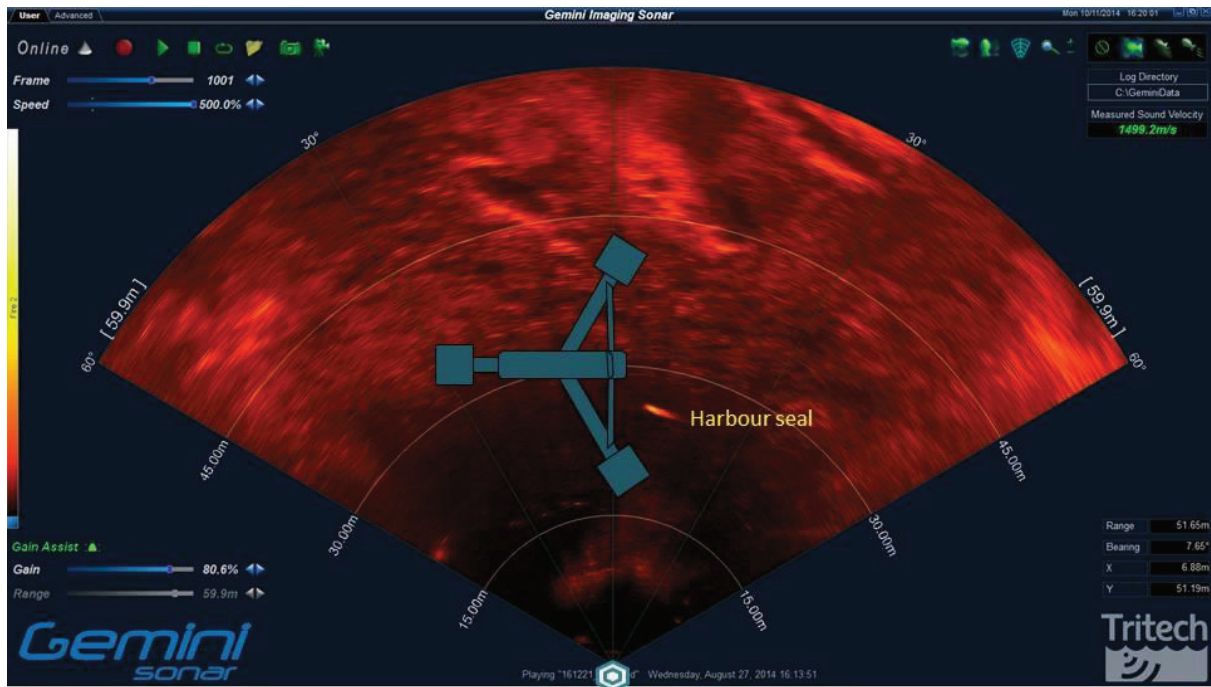
On the basis of pinger tests it is suggested that the deployment of the 83 kHz VEMCO tags in combination with GPS UHF tags, would enable tagged harbour seals to be identified and tracked in the vicinity of the turbine. This would enable tracking to an accuracy of 1-2 m around the turbine blades which would provide a relatively good spatial resolution in three 3D which would be sufficient to measure any avoidance reactions at the scale of metres around the turbine. However, it is unlikely that this would be sufficient to determine whether or not animals actually

collide with turbine blades. This information could be obtained during daylight and good visibility from the video surveillance. An analysis of the required sample size needs to be carried out to inform the tagging study design; it will be important to use an estimate of how often a tagged animal is likely to come within detection range of the system based on prior knowledge of seal movements in the area.

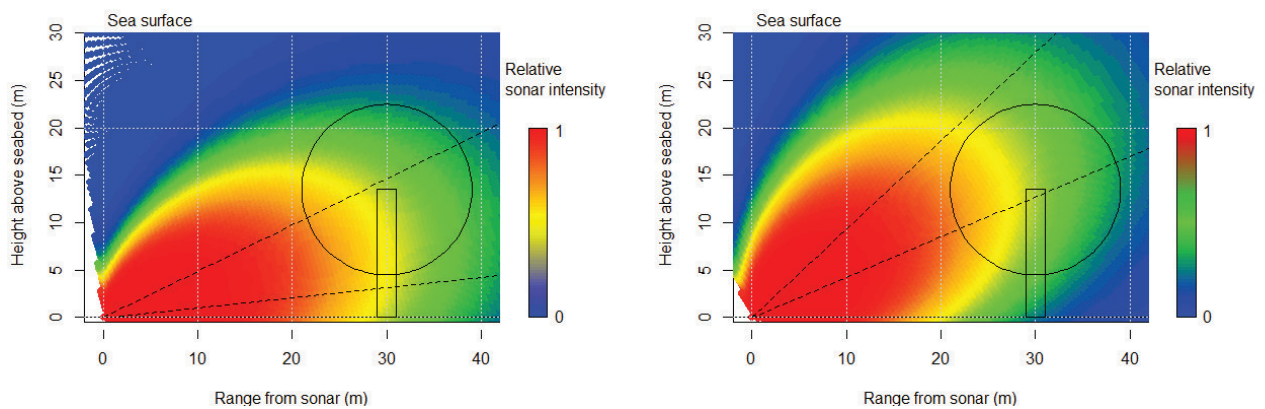
#### 8.4.3. AAM

The results of the series of tests carried out in this project using the multi-beam sonars were highly encouraging with respect to designing a sensor system to track marine mammals around tidal turbines. Specifically, the results of the detection and tracking tests of seals within a tidally energetic location (tidal currents up to approximately  $3 \text{ ms}^{-1}$ ) showed that seals could be effectively detected and tracked from a seabed mounted sonar system. Results of measurements of the spatial granularity of seal tracks produced by the detection and tracking software showed that movement behaviour in the X-Y plane would have sub-metre spatial resolution; the majority (81%) of consecutive detections were less than 0.5 m apart and 95% of all consecutive detections were less than 0.9 m apart. Furthermore, the development of the dual sonars appears to be an effective means of tracking seals in 3D in tidally energetic locations. Specifically, the results of the calibrations using the dual sonars showed that the depth of a seal could be accurately predicted by either mounting the sonars in perpendicular orientations (errors ranged from -3.0 to +4.9 m with a mean absolute error of 1.6 m) or by mounting them in an offset parallel orientation (errors ranged from -2.6 to +4.3 m with a mean absolute error of 1.5 m). Together, these results show that seals can be tracked around tidal turbines with good spatial resolution (sub-metre) in the X-Y plane and with an accuracy of around 1-2 m in the depth plane. So, any evasion responses largely in the horizontal plane will be detected with a good degree of accuracy although vertical responses will be associated with more error. This has obvious implications for the assessment of whether a collision has occurred; specifically, the error in depth estimation makes it unlikely that a collision can be reliably confirmed using the AAM system.

Based on previous development work (Hastie, 2012) and the results of this study, it is proposed that the most effective location for the seabed mounted sonars is 30 m to the side of the turbine axis and orientated so that the turbine is approximately mid frame (Figure 49 and Figure 50). This is likely to provide the best coverage of the turbine and would allow targets to be tracked in 3D both upstream and downstream of the turbine. It is proposed that a custom built pan and tilt mechanism is used to fine control the angles once the platform is deployed. Such a system is currently being specified.



**Figure 49:** A schematic of the horizontal sonar swathe coverage of a tidal turbine when the sonar is located 30 metres to the side of the turbine. The figure shows an approximation of a tidal turbine with 18 metres diameter rotors overlaid on a sonar image of a harbour seal in a tidally energetic location (Kyle Rhea).



**Figure 50:** The predicted sonar intensities of a seals in the vertical plane of dual sonars mounted 30 metres away from a tidal turbine and offset by an angle of 17 degrees; the left panel shows the lower sonar and right panel shows the upper sonar. The circle in each figure represents the approximate rotor sweep of an 18 metre diameter turbine with the rotor centred 13 metres above the seabed, the dashed lines represent the 20 degree vertical sonar swathe reported as the -3dB coverage of the sonar by the manufacturer, and the coloured areas represent the modelled intensities of a seal based on the measurements made with a grey seal carcass in Section 6.

Although good progress has been made to providing a sonar solution for tracking seals in 3D around operating tidal turbines, there are a number of development tasks that need completing prior to deployment at the MeyGen site in the Pentland Firth. Firstly, from a software perspective, the new classification algorithms and 3D

tracking will need to be integrated into the existing SeaTec software to reduce post hoc analyses. This is currently on-going and should be completed prior to deployment. Secondly, the image of the rotating turbine and any associated turbulence may result in false detections - this may need to be taken into account in the automatic detection software and any areas of significant noise 'masked' out.

From a hardware perspective, the platform that will mount the dual sonars will need to be designed and fully approved by the turbine manufacturer prior to deployment at the desired tidal turbine location. Although the HiCUP platform has been tested in Kyle Rhea in flows of up to  $4 \text{ ms}^{-1}$ , it has not been tested at the Inner Sound site. MeyGen are currently reviewing the design of the platform to assess its suitability for the Inner Sound site. It is also recommended that a protective housing is provided for the sonars to protect from debris being carried in the current. Based on the trials of polyethylene described in Section 6.5, there will need to be a clear opening for the sonar heads.

Similarly, mounting locations of the sonar topside processing and power management housings will need to be considered. Finally, if additional active acoustic sensors (e.g. ADCPs) are planned for deployment around the operating turbine, crosstalk between the systems potentially compromising the data is possible. From this perspective, synchronising the pings of the different systems should be considered. Discussion is underway between Benjamin Williamson (under a NERC Knowledge Transfer Partnership between MeyGen and the University of Aberdeen) and Trittech software engineers to develop the most effective solution.

#### 8.4.3.1. Shore Side Data Processing, Analysis and Storage

Sonar data will be processed in real time on-shore using a dedicated PC and both sonar image data (\*.ecd files) and associated detection and classification files (\*.txt files). These files will store summary information on detection timings, target tracks including X-Y locations, X-Y velocity, a measure of the probability that the target is a marine mammal, and summary information required to calculate depth) will be stored on two external 4TB HDs simultaneously (two backup datasets). The PC should have the following specifications: 16 GB RAM, 3.5 GHz (Quad-Core) processor, 3D hardware accelerated graphics card, 1600x1200 (32bit colour) display. There should have a means of remotely accessing the PC to allow monitoring offsite.

It is proposed that sonar image data is collected 24/7 together with the detection and track files for at least the first month of deployment. This should allow the efficiency of the system to be assessed prior to switching to a more data efficient means of

monitoring. Raw sonar image data (\*.ecd) from the dual sonars will be simultaneously recorded to two external hard disks. This will amount to approximately 214 GB per day; one month of data will, therefore, require approximately 12.8 TB (6.4 TB on each of two backup hard disks). Once the system has been tested over the first month of operation, it is proposed that the data collection is switched to a more data efficient means of monitoring (Table 15). Specifically, the automated marine mammal detectors will be run 24/7 to produce summary detection files (\*.txt). These will be saved on the two external disk drives. The raw image files associated with each automated marine mammal detection will also be saved automatically on the two disk drives for post hoc validation purposes. It is proposed that the summary detection files are remotely downloaded on a frequent basis (daily if practical) for storage in a database on a backup hard disk at SMRU. This would provide a means of efficiently post processing the detection and classification data to produce 3D tracks of marine mammals in the vicinity of the turbine. Remote monitoring of the data volumes on the external disk drives on the shore side PC will also provide a means of identifying when disk drives will need replacing. This approach would also provide an efficient means of reporting marine mammal detection rates and movements (pre-validation) at a desired reporting schedule or a way to quickly interrogate track data for periods of interest, e.g. if other monitoring sensors indicate a collision or close range interaction with the turbine.

Depending on MeyGen's requirements during real time operation – it is possible to configure the SeaTec software to provide alerts if potential marine mammal targets are detected within a specified range of the turbine.

#### 8.4.4. Video

A video engineer has been commissioned to finalise a design where wide-angle video cameras will be attached to each of two of the foundation legs. Power and data will be provided by a cable running parallel to (but far enough away to avoid cross talk with) the THC pod cabling. These cables will terminate in the foundation dry space provided by MeyGen.

The bandwidth requirements for twin video cameras is  $4 \text{ MB s}^{-1} = \text{c. } 350 \text{ GB per day}$ . With Gigabit Ethernet, sufficient bandwidth will be available for both this, the PAM and the AAM systems, although stability testing will be required prior to installation.

**Table 15**

Proposed data management scheduling for the active sonar system.

Activity	Location	Timing
Saving of detection and classification files (*.txt) from Gemini	Dual 4TB disk drives connected to shore side PC	Real time
Saving of raw sonar data (*.ecd) associated with detections	Dual 4TB disk drives connected to shore side PC	Real time
Download detection and classification files (*.txt) via remote access*	Disk drive located in PC at SMRU	Daily
Manually replace and archive dual 4TB disk drives connected to shore side PC	Shore side PC	Monthly**
Post process detection and classification files to create 3D tracks	PC at SMRU	Monthly

\* Dependent on internet bandwidth.

\*\* This will be dependent upon data volumes and may be more or less frequent

It is proposed that video data are collected 24/7 for at least the first month of deployment. Thereafter, it is proposed to review the quality of the recordings and to limit recording to daylight hours. It is also proposed that a single shore-side PC is dedicated to acquiring, displaying and storing video data. Data files should be appended every 24 hours so that a PC failure will result in a maximum of 24 hours of data loss. Facility should be available for regular remote downloading to a dedicated server. Also, facility should also be made available for real-time remote monitoring of images when requested.

### 8.5. Generic Application Principles

While the focus of efforts has been to develop systems which can be integrated into a specific turbine (AR1500), most of the basic design principles are applicable to the use of these sensors in other situations. Fundamental to all systems are power and communications. Both the AAM and the PAM systems require several watts of power. Similarly, both the PAM and the AAM systems produce high volumes of data with a 12 channel PAM system producing around a TB of raw data per day. While data volumes could be reduced through data compression, multiple high capacity hard drives would be required to run the system autonomously for more than a week or so.

PAM tracking accuracy is best close to the PAM array, so the preferred option will always be to mount the PAM hydrophones on the turbine support structure. As well as being close to the turbine blades, rigid mounting has the advantage of accurate

hydrophone placement which is essential for accurate localisation of sound sources. However, individual turbine designs might not allow hydrophone clusters to be attached at the required spacing for accurate tracking at the desired ranges. If hydrophones were mounted off the device on separate platforms, then a system for accurate location of the hydrophone systems would have to be developed.

To achieve full coverage of the turbine blades, a cabled AAM system needs to be sited some distance away from the structure, with the exact distance depending on the geometry of the turbine and the size of the rotor swept area. The preference is for the sonars to be to the side of the structure (looking across the current).

For video monitoring consideration needs to be given to the local visibility at the site and to the potential for bio-fouling.

The potential for interference from other monitoring systems must be considered. In particular, other active acoustic devices, for example ADCPs and other acoustic monitoring equipment (e.g. echo sounders for monitoring fish) emit high frequency signals which may interfere with the active and passive detectors, but could also potentially affect the behaviour of animals around a device. ADCPs in particular are likely to be a necessary part of tidal turbine deployments and, therefore, will always be an issue that needs to be considered. The potential for inter sensor interference can be addressed by synchronisation of devices. However, the potential for avoidance may pose a more serious problem when trying to measure and interpret the behaviour of marine mammals around tidal energy devices. It is important that any monitoring/measurement systems that are unique to the demonstration, instrumented turbine installation, have minimal biological effect.

## **8.6. Data Analysis Requirements in Relation to Final Deployment**

Existing information on harbour seal abundance in Gills Bay (where the MeyGen turbine will be installed) suggests that the encounter rate with the turbine will be low (Thompson *et al.*, 2015). Little information exists about the likely encounter rate with harbour porpoises. As a result, it is likely that a monitoring programme would have to last for at least a year in order to gather sufficient data to estimate both close encounter rates and evasion behaviour, which are the data needed to parameterise collision risk models.

The proposed sensor deployment will produce three data sets: PAM, AAM and video surveillance. It is likely that data will be generally sparse due to the expected low encounter rate of seals and porpoises. It is also likely that data about individual



encounters will be fragmented. For PAM this may be due to fragmented click/ping sequences due to changes in posture of a porpoise or acoustically tagged seal, and thus the received acoustic signal level. There will still be a degree of error in the locational information for each detection. For AAM there will still remain an element of uncertainty about the exact position and classification of the perceived target. For video surveillance it is also likely that there will remain an element of uncertainty about the exact position of the target in relation to the blades. It would be useful, therefore, to consider the construction of a Bayesian movement model that could incorporate these three disparate data sets (with uncertainty) to predict a best estimate (with uncertainty) of the 3D trajectory of animals in the vicinity of a turbine blade. This will provide a better ability to make inferences about the behaviour of animals around turbines, and to determine whether collisions are taking place.

Similarly, there will be a level of uncertainty as to how well video surveillance (during the windows in which it can operate) detects the outcome of an encounter - whether there was successful evasion or a turbine impact. An uninterrupted vocal sequence of clicks continuing after a close encounter with the rotor area would suggest that a porpoise has evaded impact. Similarly, if the track data suggests an interrupted movement path this would suggest a lack of impact. Again, there is a need to combine data sets (and perhaps others such as strain gauge information on the turbines) in a Bayesian model to estimate the most likely outcome of a close encounter.

## 9. Literature Cited

Band, B., Thompson, D., Sparling, C., Onoufriou, J., San Martin, E. and West, N. in review. Refining estimates of collision risk for harbour seals and tidal turbines. SMRU Consulting and ABPmer report to Marine Scotland. Report number SMRUC-ANP-2016-006 March 2016.

Chawla, N.V., Bowyer, K.W., Hall, L.O. and Kegelmeyer, W.P. 2002. SMOTE: synthetic minority over-sampling technique. *Journal of Artificial Intelligence Research*, 16(1): 321-357. (implemented in R package 'unbalanced').

Cryer J.D. and Chan K.S. 2008 *Time Series Analysis With Applications in R*. New York: Springer. ISBN 9780387759586.

Faber Maunsell & Metoc, 2007. *Scottish Marine Renewables SEA Environmental Report*. [http://www.seaenergyscotland.net/SEA\\_Public\\_Environmental\\_Report.htm](http://www.seaenergyscotland.net/SEA_Public_Environmental_Report.htm).

Gillespie, D.M., Mellinger, D., Gordon, J.C.D., McLaren, D., Redmond, P., McHugh, R., Trinder, P., Deng, X. and Thode, A. 2008. PAMGuard: Semi-automated, open source software for real-time acoustic detection and localisation of cetaceans. *The Journal of the Acoustical Society of America*, 30(5): 54-62.

Hastie, G.D. 2012. Tracking marine mammals around marine renewable energy devices using active sonar. SMRU Ltd report URN:12D/328 to the Department of Energy and Climate Change. September 2012 (unpublished).

Hastie, G.D., Russell, D.J.F., Benjamins, S., Moss, S., Wilson, B. and Thompson, D. in review. Dynamic habitat corridors for marine predators; intensive use of a coastal channel by harbour seals is modulated by tidal currents. *Behavioural Ecology and Sociobiology*.

Hastie T.J., Tibshirani R.J. and Friedman J. 2009. *The Elements of Statistical Learning: Data Mining, Inference and Prediction*. 2nd edition. New York: Springer. ISBN 9780387848587.

Johnson, M., Partan, J. and Hurst, T. 2013. Low complexity lossless compression of underwater sound recordings. *Journal of the Acoustical Society of America*, 133: 1387–1398.

Macaulay, J., Malinka C., Coram, A., Gordon J. and Northridge, S. 2015. The density and behaviour of marine mammals in tidal rapids. Sea Mammal Research Unit, University of St Andrews, Report to Scottish Government, no. MR 7.1.2., St Andrews, 53pp.

McConnell, B., Gillespie, D., Hastie, G., Johnson, M. and Macaulay, J. 2013. MR3 Methods for Tracking Fine Scale Movements of Marine Mammals around Marine Tidal Devices. Edinburgh: Scottish Government.

ORJIP, 2016. The Forward look; an Ocean Energy Environmental Research Strategy for the UK. Report to The Crown Estate, Marine Scotland and Welsh Government/ORJIP Ocean Energy, February 2016.  
[http://www.orjip.org.uk/sites/default/files/ORJIP\\_Ocean\\_Energy\\_Forward\\_Look\\_2.pdf](http://www.orjip.org.uk/sites/default/files/ORJIP_Ocean_Energy_Forward_Look_2.pdf).

R Core Team. 2012 R: A language and environment for statistical computing. In. R Foundation for Statistical Computing. URL <http://www.R-project.org/>, Vienna, Austria

Scottish Government. 2011. 2020 routemap for renewable energy in Scotland. Scottish Government <http://www.gov.scot/Publications/2011/08/04110353/0> 124pp.

Scottish Government. 2012. 2020 routemap for renewable energy in Scotland. Scottish Government <http://www.gov.scot/Resource/0040/00406958.pdf> 49pp.

Scottish Government, 2013. Draft Sectoral Marine Plans for Offshore Renewable Energy in Scottish Waters <http://www.gov.scot/Publications/2013/07/8702>

Sousa-Lima, R.S., Norris, T.F., Oswald, J.N. and Fernandes, D.P. 2013. A review and inventory of fixed autonomous recorders for passive acoustic monitoring of marine mammals. *Aquatic Mammals*, 39, 23–53.

Sparling, C.E., Coram, A.J., McConnell, B.J., Thompson, D., Hawkins, K.R. and Northridge, S. 2013. Wave & Tidal Consenting Position Paper Series: Marine Mammal Impacts. Natural Environment Research Council.

SRSL, 2012. Meygen tidal-stream turbine array environmental impact assessment: modelling encounter rate between turbines and marine mammals. Report to MeyGen, reference number 00599 (Commercially confidential).

Stansbury, A.L., Götz, T., Deecke, V.B. and Janik, V.M. 2015. Grey seals use anthropogenic signals from acoustic tags to locate fish: evidence from a simulated foraging task. *Proceedings of the Royal Society B*, 282: 20141595.

Szymanski, M.D., Supin A.Y., Bain D.E. and Henry K.R. 1998. Killer whale (*Orcinus orca*) auditory evoked potentials to rhythmic clicks. *Marine Mammal Science*, 14:676-691

Thompson, D., Onoufriou, J., Brownlow, A. and Morris, C. 2015. Data based estimates of collision risk: an example based on harbour seal tracking data around a proposed tidal turbine array in the Pentland Firth. Sea Mammal Research Unit, University of St Andrews. Report to Scottish Government.

Williamson, B.J., Blondel, P., Armstrong, E., Bell, P.S., Hall, C., Waggitt, J.J. and Scott, B.E. 2015. A Self-Contained Subsea Platform for Acoustic Monitoring of the Environment Around Marine Renewable Energy Devices - Field Deployments at Wave and Tidal Energy Sites in Orkney, Scotland. *IEEE Journal of Oceanic Engineering*, DOI: 10.1109/JOE.2015.2410851.

Wilson, B., Batty, R. S., Daunt, F. and Carter, C. 2007. Collision risks between marine renewable energy devices and mammals, fish and diving birds. Report to the Scottish Government, Marine Renewables Strategic Environmental Assessment.

Wilson B., Benjamins S. and Elliott, J. 2013. Using drifting passive echolocation loggers to study harbour porpoises in tidal-stream habitats. *Endangered Species Research*, 22:125-143

Wood S.N. 2006. *Generalized Additive Models: An Introduction with R*. Boca Raton: Chapman and Hall/CRC Press. ISBN 9781584884743.

## 10. Acknowledgements

The team would like to thank the following for assistance during field trials: Thomas Gordon, Alex Coram, Arthur Lee, Pauline Jepp, Andy Law, Susie Calderan, Russell Leaper, Andy Coggan and the crew of the Toohey II, Benjamin Williamson and Shaun Fraser.

Thanks also to the Project Steering Group and the team at MeyGen and University of Aberdeen: Ed Rollings, Fraser Johnson, Dave Rigg, Lorna Slater, Benjamin Williamson and Beth Scott.

The equipment was deployed in accordance with Licence Number 05624/15/0, we would like to thank MSLOT for helpful and efficient processing of the licence application despite the short notice given.

This work was also supported by National Capability funding from the Natural Environment Research Council to the Sea Mammal Research Unit (grant no. SMRU1001).

## 11.0 Glossary

AAM	Active Acoustic Monitoring
ADCP	Acoustic Doppler Current Profiler
AR1500	Atlantis 1.5 MW turbine
DAQ	Data Acquisition
Db	Decibel (unit of sound)
DECC	Department of Energy and Climate Change
EK60	Simrad Echosounder
FLOWBEC	Flow and Benthic Ecology 4D
GB	Gigabyte
GPS	Global Positioning System
GSM	Global System for Mobile Communications
HiCUP	High Current Underwater Platform
HRA	Habitats Regulations Assessment
kHz	Kilohertz
LAN	Local Area Network
LED	Light emitting diode
MB	Megabyte
Mbps	Megabits per second
MCMC	Markov Chain Monte Carlo
NERC	Natural Environment Research Council
NI	National Instruments
NMEA	National Marine Electronics Association
ORJIP	Offshore Renewables Joint Industry Programme
PAM	Passive Acoustic Monitoring
PAMGuard	Software used for collecting and processing PAM data
ROV	Remotely operated vehicle
RS232	Communications protocol
SDM	Survey Deploy and Monitor
SEA	Strategic Environmental Assessment
SGDS	Scottish Government Demonstration Strategy
SMRU	Sea Mammal Research Unit

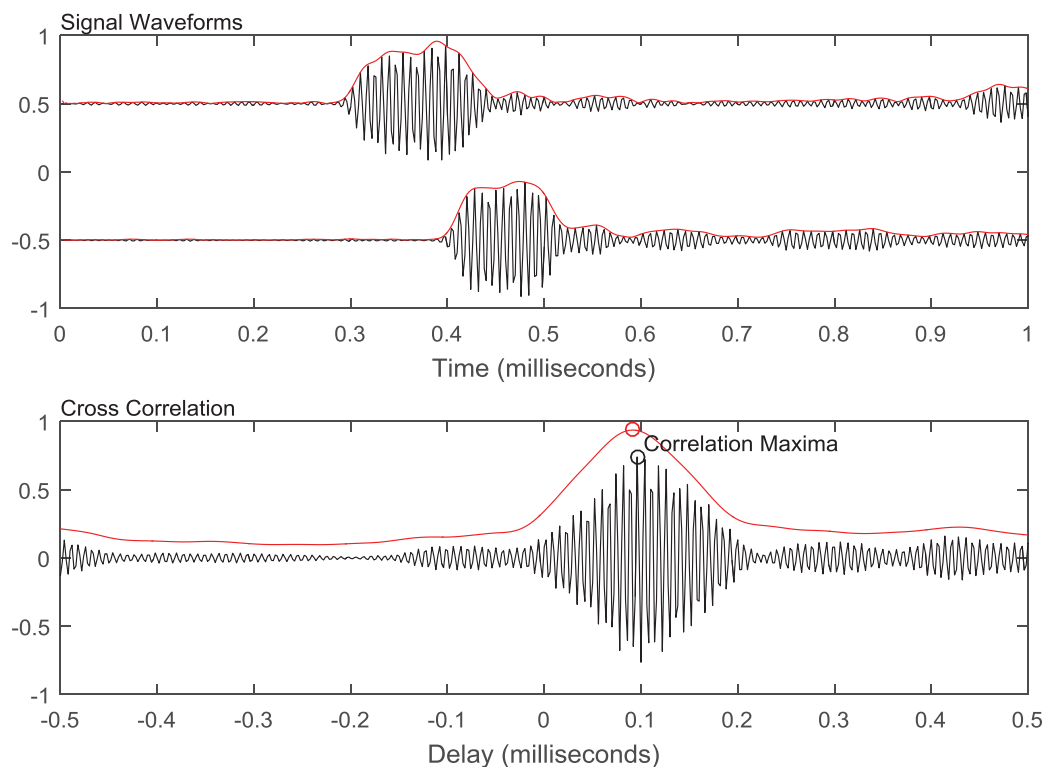
SVM	Support Vector Machine
TB	Terabyte
TEL	Tidal Energy Ltd
TOAD	Time of arrival delay
THC	Tetrahedral Hydrophone Clusters
UHF	Ultra High Frequency
UV	Ultraviolet
VHF	Very High Frequency
VEMCO	Brand name for animal borne acoustic tracking tags

## 12. Appendix A

### Development of New PAM Timing Algorithms

This appendix describes work undertaken to improve the accuracy of time of arrival differences for VEMCO tag signals, an essential step in localisation using a PAM array.

The standard method of estimating the time delay between two signals is to find the peak in the cross correlation function of those signals as shown in Figure 51. Even for porpoise clicks which are relatively short, the repetitive nature of the click's waveform can result in a multi-peaked cross correlation function making it difficult to select the correct peak. This problem becomes significantly worse in the presence of noise and reverberation (echoes), all of which distort the signal waveforms.

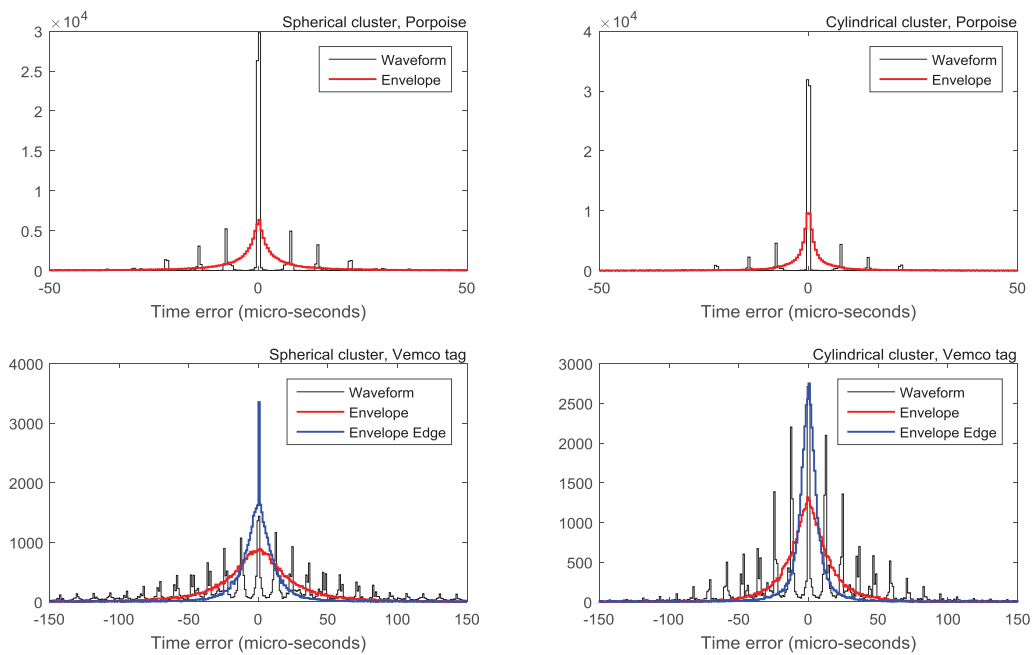


**Figure 51:** Porpoise signal waveforms on two channels and their cross correlation function (black lines). Also shown are the waveform envelopes and cross correlation function of the waveform envelopes (red lines). The time delay is taken as the maximum of the cross correlation function which in this example is around 0.1 ms.

Figure 52 shows the differences between successive time delay measurements arising from artificial porpoise like clicks spaced 0.1 s apart. The sound source would have moved a negligible distance in this time, so time delay measurements should be nearly identical. This is consistent with the strong peak in Figure 52 at

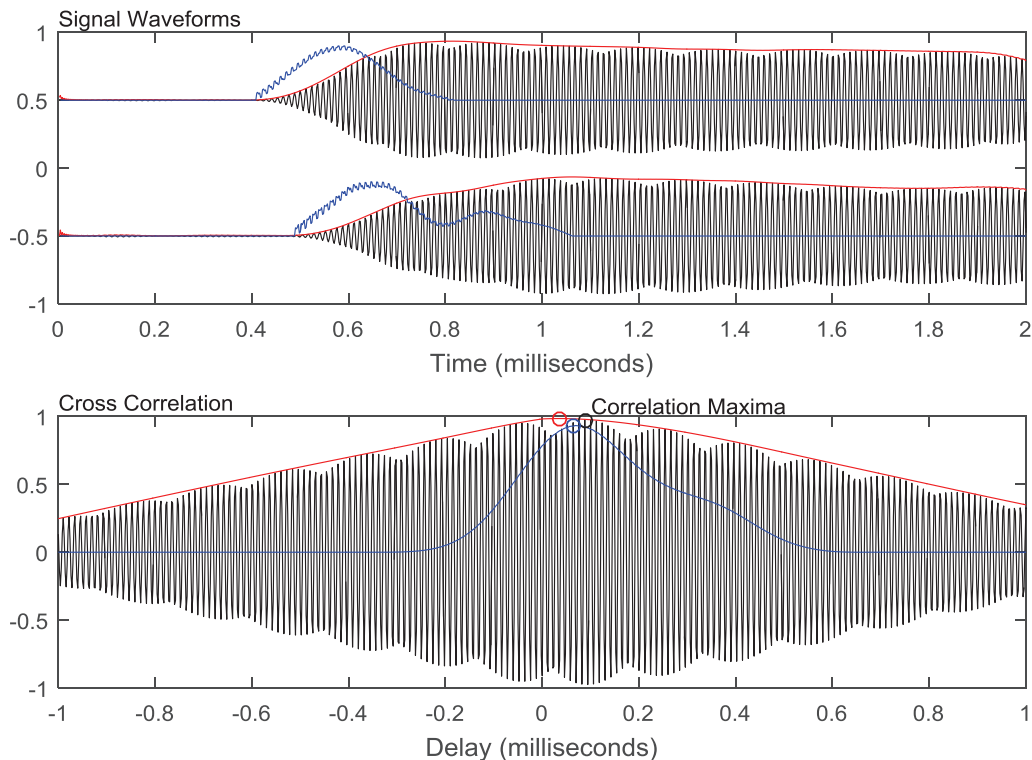


zero time difference, which has a width of around  $0.3\mu\text{s}$ , i.e. less than  $1/6$  of a sample. However, several other peaks are visible to the right and left of the central peak, representing measurements where the cross correlation is 1, 2 or 3 cycles of the waveform out. For porpoise clicks, 30% of timing measurements lie in these secondary peaks of the timing histogram. The standard deviation for time differences is  $8\mu\text{s}$  (excluding a small number of outliers with gross timing errors  $> 50\mu\text{s}$ ). Assuming independence between the timing errors on each click, this suggests a timing error on each measurement of around  $5\mu\text{s}$ .



**Figure 52:** Timing differences between adjacent clicks for different click types on the two hydrophone clusters from Calibration trials conducted in the Sound of Sleat. Note the different horizontal scales used for the porpoise clicks and VEMCO tags (porpoise click timing being more accurate than VEMCO tag timing).

For the longer duration VEMCO tag signals (Figure 53) the cross correlation function contains many peaks with similar maximum values and it becomes even harder to select the correct one. This problem is exacerbated by signal distortion caused by echoes from nearby structures which start to arrive and distort the signal long before the original pulse has been captured. Figure 52 also shows timing errors calculated in the same way for VEMCO tags. Clearly the number of timing measurements with a large error, caused by the wrong peak being selected, is much greater than that for the shorter porpoise clicks.



**Figure 53:** Signal waveforms (black), envelopes (red) and leading edge envelopes (blue) (top Panel) and their cross correlation coefficients (bottom panel) for signals from a VEMCO tag. Note the multiple similar sized peaks on the waveform cross correlation. The peak of the correlation functions based on waveform envelope (red lines) and on the leading edge of the waveform envelope (blue lines) are clearly better defined.

An alternative to cross correlating the signal waveform is to cross correlate the waveform envelope. The waveform envelope (also known as the analytic signal, shown in red in Figure 51 and Figure 53), is calculated from the Hilbert transform of the original waveforms. Cross correlations derived from the waveform envelope tend to have a single peak rather than multiple peaks, meaning that identification of the wrong peak is unlikely. However, there is the trade-off that the broader nature of the single peak, also means that the maximum of that peak is less well defined. For the porpoise click example in Figure 51 the timing difference between the two methods is 1.4 samples, whereas for the VEMCO pings it is 26 samples.

Another refinement when using the waveform envelope for cross correlation is to use only the rising edge of the envelope. This is advantageous because the rising edge is the part of the signal least likely to be distorted by echoes and reverberation. To find the leading edge, the first derivative of the envelope is taken and the first peak identified. The extent of the first peak is then taken as being the part of the envelope derivative for which that first peak is above zero and all data outside that first peak are set to zero (blue line in Figure 53, top panel). Timing accuracy for porpoise-like clicks and VEMCO tags for different correlation methods are presented in the main

body of this report, Section 5.2.2, Table 8. For porpoise clicks, using the waveform envelope made little difference to timing accuracy. However, for the VEMCO tag signals, using the leading edge of the waveform envelope reduced timing errors by a factor three.

Integration of this new timing method into the PAMGuard software is described in Section 5.4.1.

## Appendix B

### Seal Depth Calculation from Vertically Offset Multi-beam Sonars

The vertical beam pattern of the sonars was measured by lowering and raising the seal vertically through the swathe of one of the sonars; the relationship between the measured intensity on the sonar and both the angle of declination (degrees) and the range (metres) from the sonar heads (measured using the depth of the OpenTag together with the measured distance on the sonar) was modelled in a generalised linear model with Gaussian errors and an identity link function. The best fit model of the patterns of intensity of the grey seal carcass was described by Equation 1. The resultant model functions ( $\pm 95\%$  CIs) are shown in Figure 54.

Equation 1:

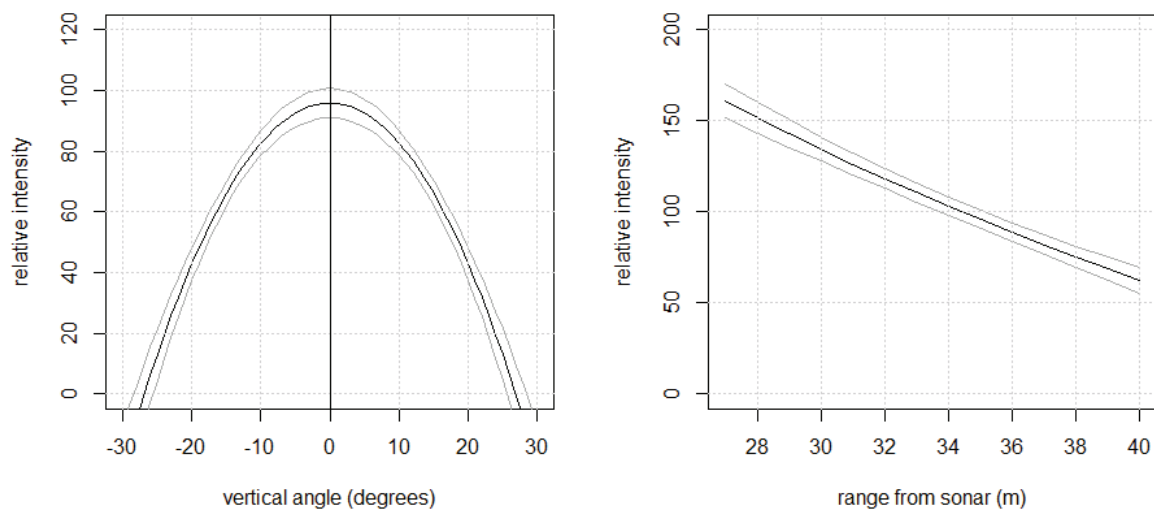
$$SI = 987.6 - (0.13 \times \alpha^2) - (577.5 \times \log_{10} d)$$

Where:

$SI$  is the relative intensity of the seal measured on the sonar,

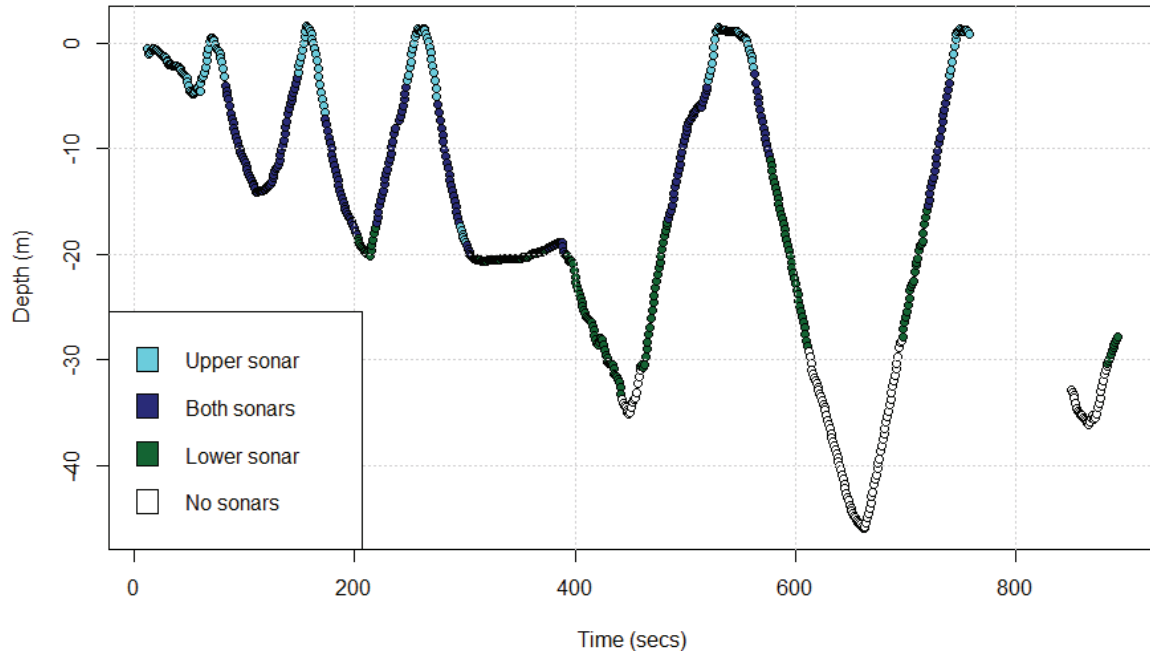
$\alpha$  is the vertical angle of the seal in degrees relative to the centre of the vertical beam of the sonar,

$d$  is the range in metres of the seal from the sonar.

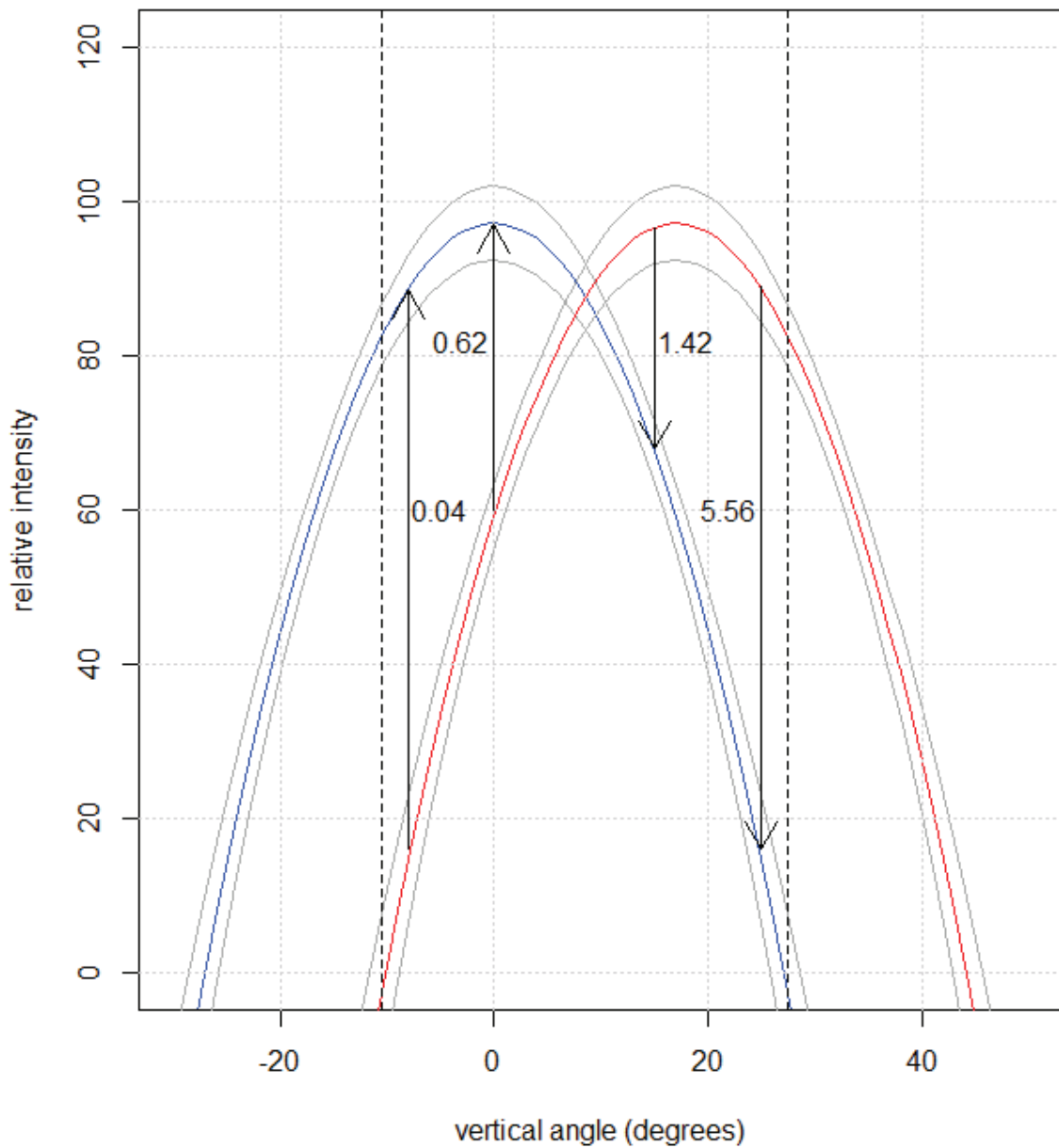


**Figure 54:** Patterns of signal intensity of a grey seal measured on a 720 kHz multibeam imaging sonar. The figure shows the best fit model functions ( $\pm 95\%$  CIs) of a Generalised Linear Model (GLM) of the intensity values with vertical angle through the sonar swathe and with range from the sonar.

The second sonar was then mounted alongside the first and was orientated in the same horizontal angle but was orientated vertically with an offset angle of  $17^{\circ}$ . This provided an area where the swathes of the two sonars overlapped and the seal could be detected on both sonars (Figure 55). Over the period when the seal was visible on both sonars, the peak intensity of the seal was measured on each sonar at one second intervals and the ratio of intensities between the sonars was computed (Figure 56). The angle of declination of the seal from the water surface was calculated by comparing the intensity ratios to the expected ratios based on the modelled vertical beam pattern of the sonars (Figure 56). These angles, together with the measured ranges of the seal from the sonar, provided the information to calculate the depth of the seal at one second intervals. These depths were then divided into vertical tracks (where the seal was detected continuously on both sonars). Each vertical track was smoothed using a uni-variate penalized cubic regression spline smooths implemented using the package ‘mgcv’ (Wood, 2006) in the statistical software R (R Core Development Team, 2012) to produce a series of modelled depths ( $\pm$  95% CIs) for each vertical track. Modelled depths were then compared to those measured on the depth logger to estimate the accuracy of the method for predicting dive depth.



**Figure 55:** The depth measurements from the depth logger affixed to the grey seal carcass as it was lowered and raised through the dual sonar beams at a range of between 27 and 40 metres from the sonar. The points are colour coded to show whether the seal was detected on the upper sonar only (light blue), both sonars (dark blue), the lower sonar only (green), and neither sonar (white).



**Figure 56:** Example of the expected ratio of sonar intensities for a seal based on two 720 kHz multibeam imaging sonars offset by a vertical angle of 17 degrees. In this example, a ratio of less than, or greater than one would be expected if the seal was at a vertical angle less than, or greater than 8.5 degrees from the centre of the upper sonar respectively.

**APPENDIX D: MONITORING EQUIPMENT MATRIX**

EQUIPMENT MATRIX - MEYGEN PHASE 1A								
	Equipment name	Description	Ownership	Recovery Responsibility	Consequences of equipment failure	Impact upon S.36 condition 12	Redundancy	Impact High/Medium/Low
FLOWBEC	Imagenex	Active Sonar	NOC	MeyGen	Loss of target tracking, classification and behavioural responses in vertical swath.	Condition 12 (b) (d)	EK60 and Gemini 1 & 2	H
	EK60*3	Echosounder / active sonar	NOC/SG	MeyGen	Loss of target classification and species ID (with known frequency response)		Imagenex and Gemini 1 & 2	H
	Frame	Frame on which equipment sits	NOC/SG/UoA	MeyGen	Loss of frame and all FLOWBEC equipment		Rely on SGDS equipment	H
	Umbilical	Power and data cable connecting to TSS	MeyGen	MeyGen	Loss of power and data to / from FLOWBEC		Redeploy autonomous FLOWBEC system run off batteries. Then regular recovery and deployment.	H
	Junction Box	Where umbilical connects to TSS	Current: NOC/SG	MeyGen	Loss of power and data to / from FLOWBEC		Redeploy autonomous FLOWBEC system run off batteries. Then regular recovery and deployment.	H
			MeyGen due to replace					
	Controller	To remotely control the monitoring equipment	NOC/SG/UoA	MeyGen	Loss of control to monitoring equipment		Redeploy autonomous FLOWBEC system run off batteries. Then regular recovery and deployment.	H
	ADV	Provides near-bed flow and turbulence data	NOC	MeyGen	Loss of near-bed flow and turbulence data		ADCP on FLOWBEC and ARL TSS.	L
	Sig500 ADCP	Measures flow velocity, turbulence and waves	MeyGen	Retrievable	Loss of flow velocity, turbulence and wave data		Rely on ARL TSS ADCP	L
Fluorometer	Measures turbidity and fluorescence	UoA	MeyGen	Loss of turbidity and chlorophyll data	Redeploy autonomous FLOWBEC system run off batteries. Then regular recovery and deployment. Unlikely if failure with fluorometer only.	L		
HiCUP	Gemini 1	Active Sonar	SG	Retrievable	Loss of 3D tracking and only partial coverage of rotor swept area.	Condition 12 (b)	Rely on only 1 Gemini and FLOWBEC	H
	Gemini 2	Active Sonar	SG	Retrievable	If both Gemini fail then no active sonar		Rely on FLOWBEC	H
	Frame	Frame on which equipment sits	SGDS	Retrievable	Loss of frame and equipment on it.		Rely on FLOWBEC	H
	Umbilical	Power and data cable connecting to TSS	MeyGen	Non retrievable	Loss of power and data to HiCUP		Rely on FLOWBEC	H
	Junction Box	Where umbilical connects to TSS	SGDS	Non retrievable	Loss of power and data to HiCUP		Rely on FLOWBEC	H



ARL TSS	Camera 1	Video	SGDS	Non retrievable	Loss of footage from one side of turbine	Condition 12 (b)	Rely on second SGDS camera and camera on nacelle. Also strain gauge / accelerometer data for blade impact	H
	Camera 2	Video	SGDS	Non retrievable	Loss of footage from both sides of turbines		Rely on camera on nacelle. Also strain gauge / accelerometer data for blade impact	H
	HP Cluster 1	Passive Acoustic Monitoring	SGDS	Non retrievable	Loss of PAM from 1 hydrophone = no 3D tracking ability		Rely on 2 hydrophones	H
	HP Cluster 2	Passive Acoustic Monitoring	SGDS	Non retrievable	Loss of PAM from 2 hydrophones = no tracking ability		Rely on 1 hydrophone	H
	HP Cluster 3	Passive Acoustic Monitoring	SGDS	Non retrievable	Loss of PAM from 3 hydrophones = no PAM		No Redundancy	H
	PAM Controller	PAM Controller	SGDS	Non retrievable	Loss of PAM		No Redundancy	H
	Comms & Power	Cables for communications and power	MeyGen / ARL	Non retrievable	Loss of PAM and camera footage	Condition 12 (b) (d)	No Redundancy	H
Junction Box	Where cables connect	MeyGen / ARL	Non retrievable	Loss of PAM and camera footage	No Redundancy		H	
ARL Nacelle	ADCP	Measures flow velocity, turbulence and waves	MeyGen / ARL	Non retrievable	Loss of flow velocity, turbulence and wave data	Condition 12 (a)	Rely on FLOWBEC	L
	Camera	Video	MeyGen / ARL	Non retrieveable	Loss of footage	Condition 12 (b) (d)	Rely on cameras on TSS, and strain gauge / accelerometer data for blade impact	H
	Strain gauge / accelerometer	Measures blade impact	MeyGen / ARL	Non retrieveable	Loss of strain gauge / accelerometer data	Condition 12 (b) (d)	Possibly rely on cameras for blade impact	H
PCUB (onshore substation)	FLOWBEC PC	Computers receiving and storing data from monitoring equipment	MeyGen	N/A	Loss of monitoring data	Condition 12 (b) (d)	Rely on SGDS PCs	H
	SGDS computer	Computers receiving and storing data from monitoring equipment	SGDS	N/A	Loss of monitoring data	Condition (b)	Rely on FLOWBEC PCs	H
AHH TTG x 3	Camera 1	Video	AHH	Non retrievable	Loss of footage from small part of rotor swept area	Condition 12 (b) (d)	Rely on other 2 cameras and strain gauges	H
	Camera 2	Video	AHH	Non retrievable	Loss of footage from large part of rotor swept area		Rely on 1 camera and strain gauges	H
	Camera 3	Video	AHH	Non retrievable	Total loss of footage from rotor swept area		Rely on strain gauges	H
	Strain gauges	Measures blade impact	AHH	Non retrievable	Loss of strain gauge data		Rely on cameras	H