

Offshore Test Site alpha ventus

Expert Report: Marine Mammals

Final Report: From baseline to windfarm operation



Armin Rose, Ansgar Diederichs, Georg Nehls,
Miriam J. Brandt, Sophia Witte, Caroline Höschle, Monika Dorsch,
Thilo Liesenjohann, Alexander Schubert, Vladislav Kosarev,
Martin Laczny, Annika Hill, Werner Piper

Husum, February 2014

funded by: Deutsche Offshore-Testfeld- und Infrastruktur GmbH & Co. KG (DOTI)

Cover image: Lutz von der Heyde

Content

1	INTRODUCTION	1
2	METHODS	3
2.1	General methodology.....	3
2.1.1	Project area	3
2.1.2	Windfarm construction work	4
2.1.3	Study concept according to StUK3	9
2.1.4	Phase I: Baseline survey	10
2.1.5	Phase II: Construction phase	10
2.1.6	Phase III: Operation phase	10
2.1.7	Deterrence.....	11
2.2	Aerial surveys	11
2.2.1	Visual aerial surveys	12
2.2.2	HiDef digital aerial surveys.....	21
2.3	Vessel-based surveys.....	22
2.3.1	Data recording.....	22
2.3.2	Data analysis.....	25
2.4	Passive acoustic monitoring.....	26
2.4.1	General concept	26
2.4.2	Change in methodology from T-POD to C-POD systems.....	27
2.4.3	Technical properties.....	27
2.4.4	POD stations and station clusters	29
2.4.5	POD deployment procedure	30
2.4.6	POD deployment periods and recording times.....	31

2.4.7	POD data analysis	33
3	RESULTS	39
3.1	Aerial surveys	39
3.1.1	Visual aerial surveys	39
3.1.2	HiDef digital video surveys	51
3.2	Vessel-based surveys.....	53
3.2.1	Harbour porpoises.....	53
3.2.2	Seals and other marine mammals.....	57
3.3	Passive acoustic monitoring	59
3.3.1	Results across phases	59
3.3.2	Phase I & II.....	68
3.3.3	Phase III	86
4	DISCUSSION	87
4.1	Project alpha ventus.....	87
4.2	Methodology	87
4.3	Harbour porpoise	89
4.3.1	Presence, density, phenology, calves.....	89
4.3.2	Effects of windfarm construction.....	91
4.3.3	Effects of windfarm operation	94
4.4	Harbour seal and grey seal	96
4.4.1	Presence, phenology	96
4.4.2	Effects of windfarm construction and operation	97
4.5	Evaluation of StUK3.....	98
4.6	Synopsis and outlook.....	98
5	SUMMARY	101

6	DEUTSCHE KURZFASSUNG	103
6.1	Einleitung und Methoden	103
6.2	Ergebnisse	104
6.3	Zusammenfassende Diskussion.....	112
7	REFERENCES	115
8	SUPPLEMENTS.....	128
8.1	Definitions	128
8.2	Methods	130
8.2.1	Windfarm construction works.....	130
8.2.2	T-POD specifications.....	131
8.2.3	Converting T-POD data into C-POD equivalents	133
8.3	Results	139
8.3.1	Aerial surveys	139
8.3.2	Vessel-based surveys.....	146
8.3.3	Passive acoustic monitoring.....	149

1 INTRODUCTION

The first offshore windfarm (OWF) in German marine waters, alpha ventus, has been constructed between April and November 2009 in the German Bight about 45 km north of the island of Borkum (Fig. 1-1). This windfarm functions as a test site and is fully operating since April 2010. Compared to more recently built windfarms (e.g., Borkum West II) it is rather small: twelve offshore wind turbines (OWT) were erected on an area of 4 km².

The intention behind the project alpha ventus was to gain technical experience regarding the new techniques of offshore wind power production, as well as to investigate the ecological effects of offshore windfarms as to the Standards for Environmental Impact Assessments (StUK3) of the German Federal Maritime and Hydrographic Agency (BSH 2007). By these standards, it is demanded to investigate the effects of the construction and operation of windfarms on marine environments. Furthermore, results of the project alpha ventus are intended to provide a basis for evaluation of StUK3 according to its appropriateness and efficiency (StUK3 was recently followed by StUK4; BSH 2013).

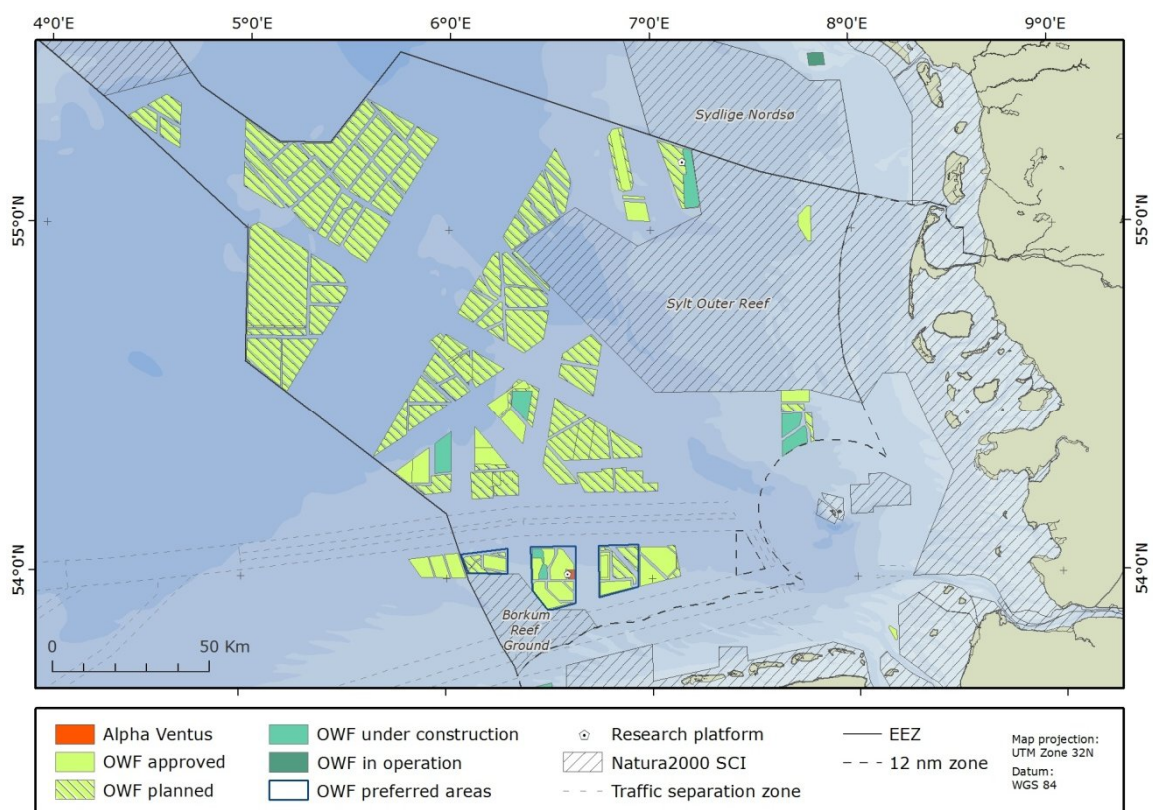

Fig. 1-1: Position of offshore windfarm (OWF) test site alpha ventus (red), other offshore planning areas, and protected areas within the German Exclusive Economic Zone (EEZ) (map date: autumn 2013).

Since 2008 planning, construction, and operation of alpha ventus is accompanied by monitoring of marine mammals according to StUK3 by BioConsult SH (Husum) and IfAÖ (formerly: biola, Hamburg) on behalf of the Deutsche Offshore-Testfeld- und Infrastruktur GmbH & Co. KG (DOTI).

In the alpha ventus area harbour porpoise (*Phocoena phocoena*), harbour seal (*Phoca vitulina*), and grey seal (*Halichoerus grypus*) were observed regularly (Laczny et al. 2009, Diederichs et al. 2010). The harbour porpoise is classified as endangered species (status 2) in Germany's National Red List (Haupt et al. 2009), and listed in the EU Habitats Directive, Annex II and IV (European Council 1992). The grey seal is classified as endangered species (status 2), harbour seal as vulnerable species (status 3) in Germany's National Red List; both are listed in the EU Habitats Directive, Annex II and IV. These animals are in need of strict protection, and Special Areas of Conservation (SAC) are to be designated according to Annex II of the EU Habitats Directive. In the most recent Natura 2000 report of the German Federal Government, the conservation status of harbour porpoise in the Atlantic Biogeographic Region (North Sea) was set to „unfavourable inadequate“ (BMU 2013).

When permitting the alpha ventus project it was hypothesised that construction and operation of the offshore windfarm alpha ventus will not have significant adverse effects on harbour porpoises in the area. Still, some concerns remained about the extent of displacement during pile driving due to noise emissions and also during operation of the windfarm due to noise emissions from the turbines, as well as from increased shipping traffic necessary for maintenance. The aim of the marine mammal investigations at alpha ventus was to evaluate to what extent these concerns were concordant (or not) with the statistical results of five years of ecological field research. Since the alpha ventus project was accompanied by an extensive research project ("Ökologische Begleitforschung am Offshore-Testfeld alpha ventus zur Evaluation des Standarduntersuchungskonzepts des BSH (StUKplus)", FKZ 0327 www.stukplus.com), the report at hand concentrates on the standard methods described in the StUK3 manual (BSH 2007). Investigations were split into those concerning short-term effects of construction works, and those regarding long-term effects of the operation of windfarms on marine mammals.

According to StUK3, investigations took place before windfarm construction (Phase I: Baseline survey), during construction works (Phase II: Construction phase), and three years of operation (Phase III: Operation phase). Data obtained during construction and operation shall be compared to those obtained during a baseline period before windfarm construction.

Until now reports on marine mammals were compiled regarding the Baseline survey in 2008 before windfarm construction (Phase I; Diederichs et al. 2008), after building the transformer substation (Start of Phase II) in September 2008 (Diederichs et al. 2009a), after construction of all foundations until September 2009 (Diederichs et al. 2010), regarding the efficiency of the deterrence procedure (Diederichs et al. 2009b), for the first year of operation in 2010 (Start of Phase III in April 2010; Höschle et al. 2011), and for the second year of operation in 2011 (Hansen et al. 2013).

Here we present the final report on marine mammals. It compiles the results of preceding reports, presents recent data from 2012 and 2013, and draws final conclusions according to the project phases as well as to the overall perspective of the project alpha ventus.

2 METHODS

2.1 General methodology

2.1.1 Project area

The OWF alpha ventus is located in the German Bight about 45 km north of Borkum (Fig. 1-1; Fig. 2-1) in an area with a water depth of approximately 30 m. In total, twelve wind turbines were built on an area of 6.5 km² (Tab. 2-1). Construction works for the windfarm Trianel Windpark Borkum, Phase I (Fig. 2-1) appr. 8 km west of alpha ventus started at Sept, 9th 2011 and were finished at April, 5th 2012. Additionally foundations for the windfarm BARD Offshore 1, located appr. 45 km northwest of alpha ventus were driven into the sea bed between April, 5th 2010 and March, 3rd 2013. Between May, 30th and June 1st 2009 the transformer substation for BARD Offshore 1 was founded.

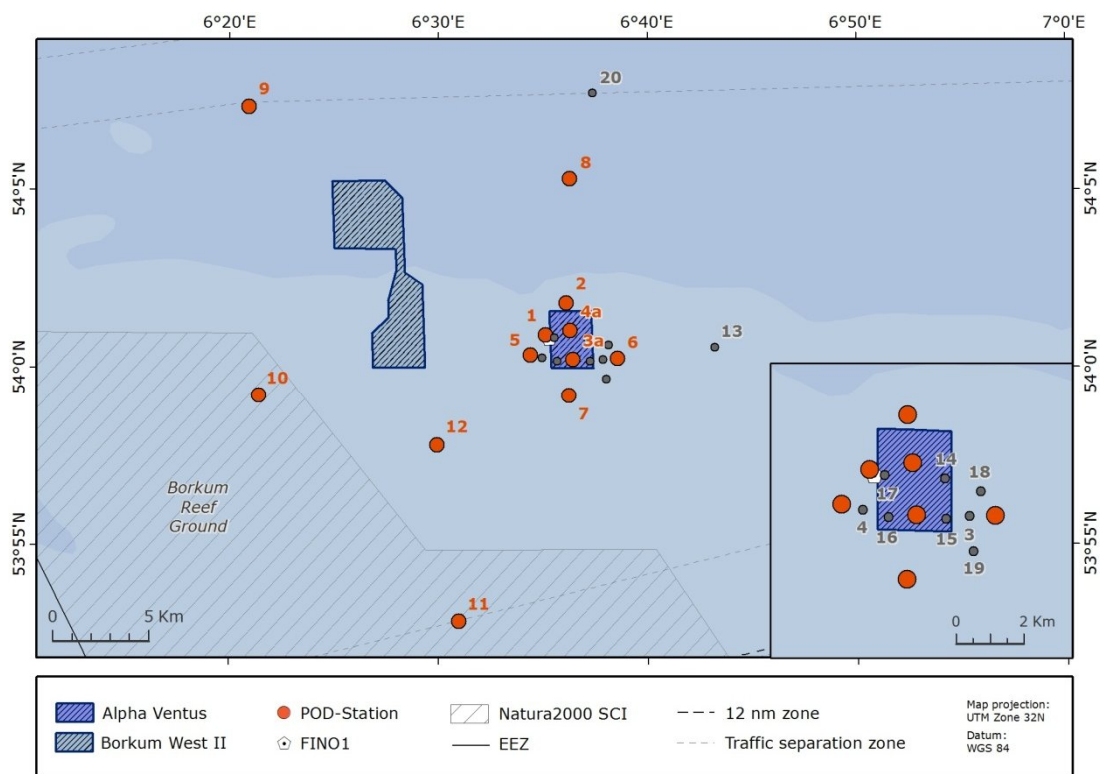

Fig. 2-1: Position of OWF alpha ventus (blue) and Trianel Windpark Borkum, Phase I (green grey), as well as porpoise detector (POD) positions 2008-2013 (grey circles: old positions; red circles: final positions; due to logistic constraints some stations were shifted during the project: see Section 2.4.4).

Tab. 2-1: Geographical coordinates of alpha ventus (chart datum: WGS 84).

	Latitude N	Longitude E
Project area (6.5 km ²)	54°00'00.00''	06°37'23.99''
	54°01'36.01''	06°37'18.01''
	54°01'36.01''	06°35'17.99''
	54°00'00.00''	06°35'24.00''

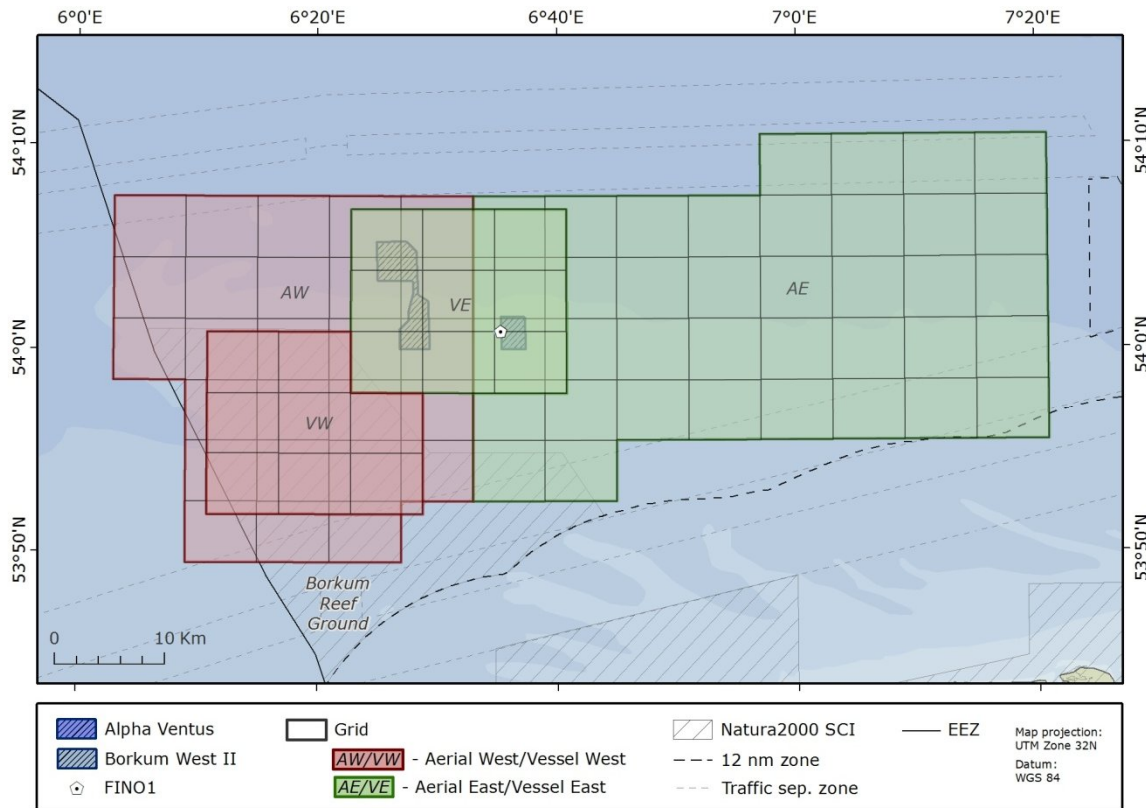

Fig. 2-2: Western and eastern subareas of visual aerial ('Aerial West'; 'Aerial East'; Fig. 2-14) and vessel-based surveys ('Vessel West'; 'Vessel East'); for clarity reasons, visual aerial survey subareas for impact analysis not shown here (see Fig. 2-15).

2.1.2 Windfarm construction work

Construction types/periods

The foundations for the transformer station were rammed between 18th and 25th of September, 2008, and those for the twelve wind turbines were driven into the seafloor between 24th of April and 26th of August, 2009. Pile driving for the foundations was subdivided into two different *Pile-driving periods* during which different types of piles were rammed, accompanied with differing duration of pile-driving activities (see Section 2.4.7, p. 34, for definitions of all ramming terms in italics):

Tripod foundations:

In a first *Pile-driving period*, six foundations for Multibrid turbines (AV7 to AV12) were driven into the sea bed. Their tripod foundations were grounded on the seafloor by three piles (Fig. 2-3, left), each with a diameter of 2.48 m. Piles were vibrated for ten minutes before piling with a hydraulic hammer started. The last pile was driven into the sediment on 1st of June, 2009. This period comprised only ten *Pile-driving events* (see Section 'Parameters and definitions', p. 34) (Supplement Tab. 8-1). The low number results from rapid changeover (often less than 60 minutes) of the hydraulic hammer to the next pile of a foundation. The average *Pile-driving event* duration was about 5:01 hours (\pm 03:45 hours). The average break time between two *Pile-driving events* amounted to 92 hours (i.e., 3 days, 20 hours).

Jacket foundations:

In a second *Pile-driving period*, lasting from 15th of June until 26th of August, 2009, six foundations for Repower turbines (R1 to R6) were founded as jacket constructions. One pile was driven into the seafloor at each of four corners of a template. Afterwards a framework of steel tubes, the base of the wind turbine, was founded at the piles (Fig. 2-3, right). This period included 63 *Pile-driving events* (Supplements: Tab. 8-1).

Pile driving for single foundations often took days, ranging from 3.5 days (R6) to 14 days (R1). *Pile-driving events* were much shorter than in the tripod period. Average *Pile-driving event* time amounted to 60 minutes (\pm 32 minutes). Due to frequent intermission of work, the average break time was only 26 hours (i.e., 1 day, 2 hours).

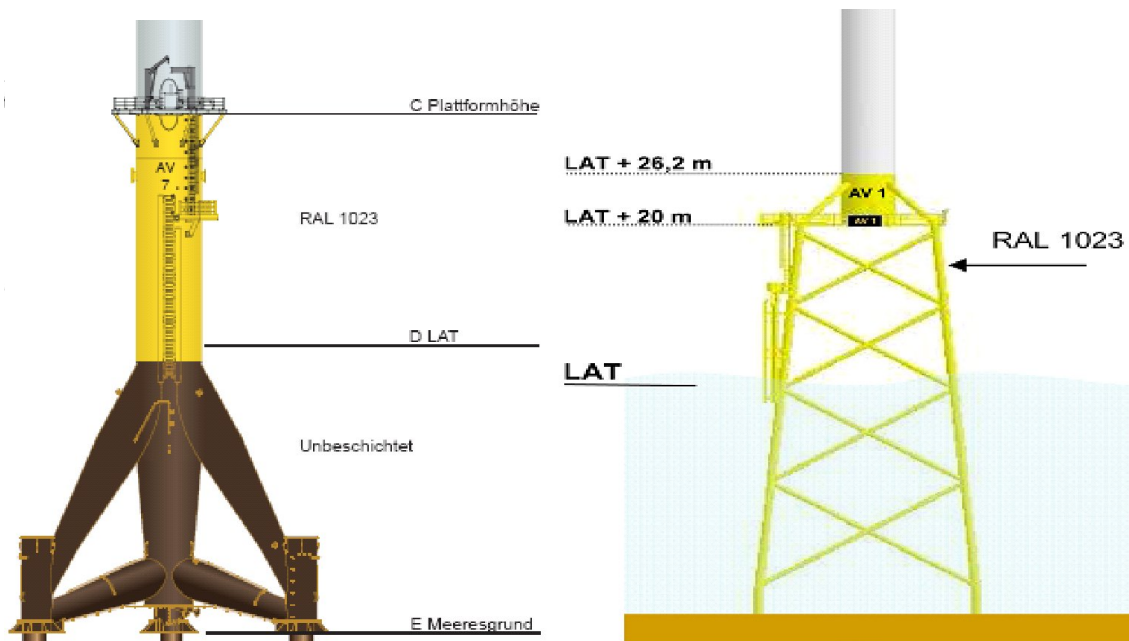

Fig. 2-3: Tripod foundations of Multibrid wind turbines (left) and Jacket foundation of Repower wind turbines (right).

Properties of *Pile-driving periods* can be summarised as follows (see Fig. 2-4):

Tripod foundations: Few *Pile-driving events* ($n = 10$) of long duration (~ 5 hours) with many strokes (mean: 10,623) and long breaks (~ 4 days).

Jacket foundations: Many *Pile-driving events* ($n = 63$) of short duration (~ 1 hour) with fewer strokes (mean: 1,493) and short breaks (~ 1 day).

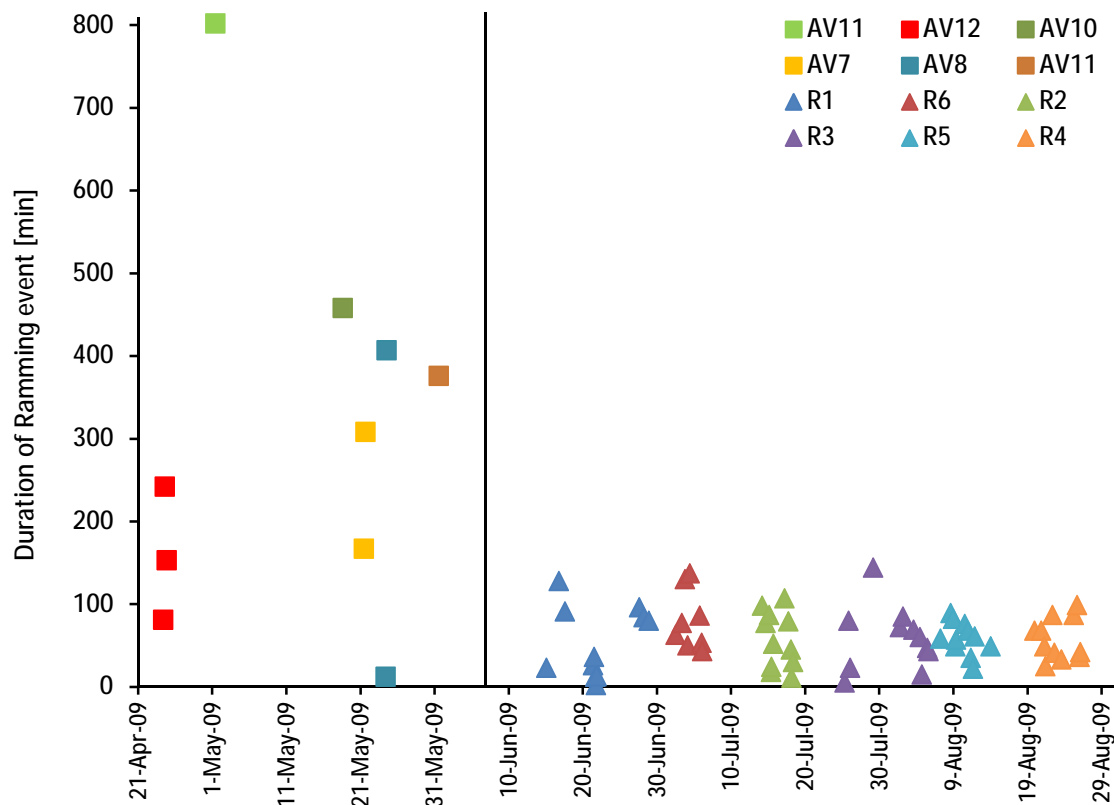

Fig. 2-4: Date and duration of Pile-driving events for the offshore windfarm alpha ventus; vertical line separates Tripod (left) from Jacket (right) Pile-driving events.

Underwater noise immission

The Institute for Technical and Applied Physics (itap GmbH, Oldenburg) measured underwater noise levels during some pile-driving activities for alpha ventus (Betke & Matuschek 2011). Values for AV5 (1,700 m distance) and AV8 (1,500 m distance) as well as single event sound levels calculated for a distance of 750 m are shown in Tab. 2-2. The underwater noise threshold value of the German Federal Maritime and Hydrographic Agency (BSH 2010) and the German Federal Environment Agency (UBA 2011) of 160 dB_{SEL} for the sound exposure level in 750 m distance from pile driving were exceeded by 8-10 dB_{SEL} on average (median).

The statistical distribution of SEL values during pile driving with predicted sound levels at different distances from the sound source (according to Betke & Schultz-von Glahn 2008) is plotted in Fig. 2-5. Until 2.5 km the median values followed the predictions, whereas measured values were lower than predicted at distances of more than 10 km from the sound source. A newer and im-

proved empirical sound propagation function obtained with pile driving for OWF Trianel Windpark Borkum, Phase I is shown in Fig. 2-6 (Diederichs et al. 2014). Here, a sound level of 160 dB_{SEL} was predicted to occur at a distance of about 3.2 km from pile driving.

Sound levels of turbines in operation rarely exceeded 115 dB_{L50} under full load (Betke & Matuschek 2012).

Tab. 2-2: Broad-band SEL in dB during pile-driving for foundations AV5 and AV8, with predicted values as to 750 m distance (rounded; after Betke & Matuschek 2011).

Distance (m)	AV5		AV8	
	1,700 (measured)	750 (predicted)	1,500 (measured)	750 (predicted)
SEL max (dB)	172	175	169	173
SEL 75% (dB)	166	170	167	171
SEL med (dB)	165	168	166	170
SEL 25% (dB)	163	167	164	168
SEL min (dB)	155	158	161	165

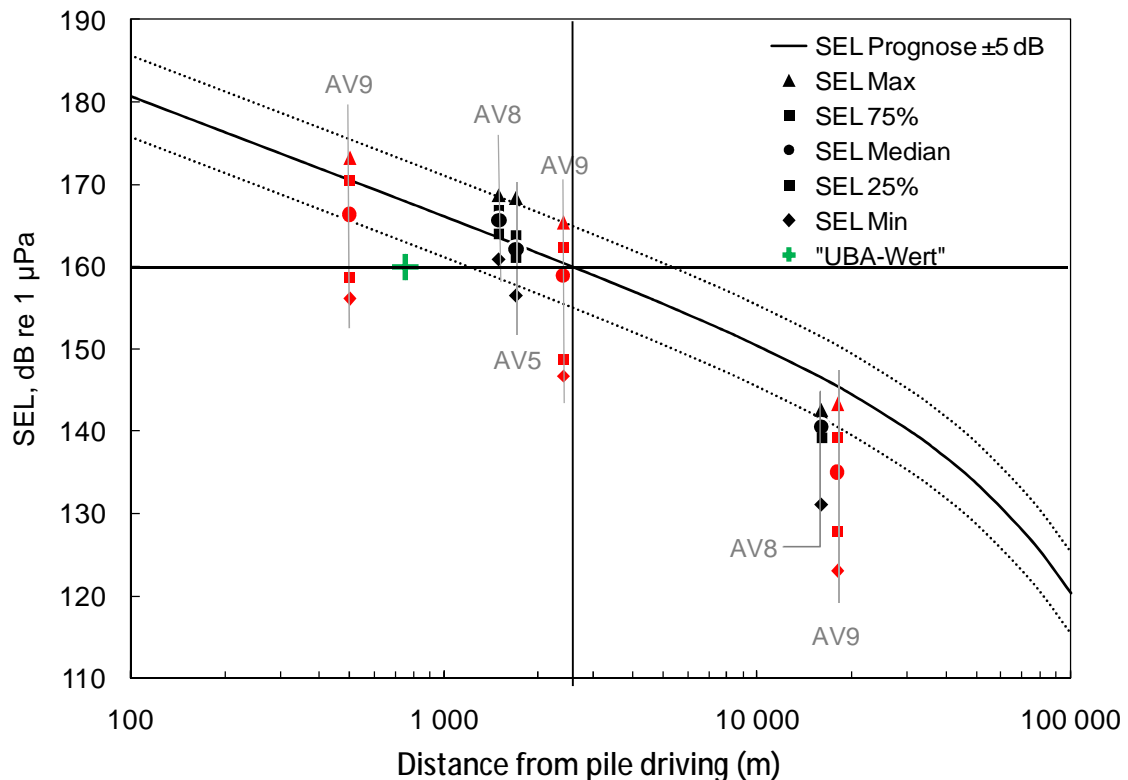

Fig. 2-5: Measured SEL at alpha ventus foundations AV5, AV8, and AV9, as well as predicted curves (after Betke & Matuschek 2011). At AV9 pile driving was conducted with and without noise mitigation system, causing higher SEL variability.

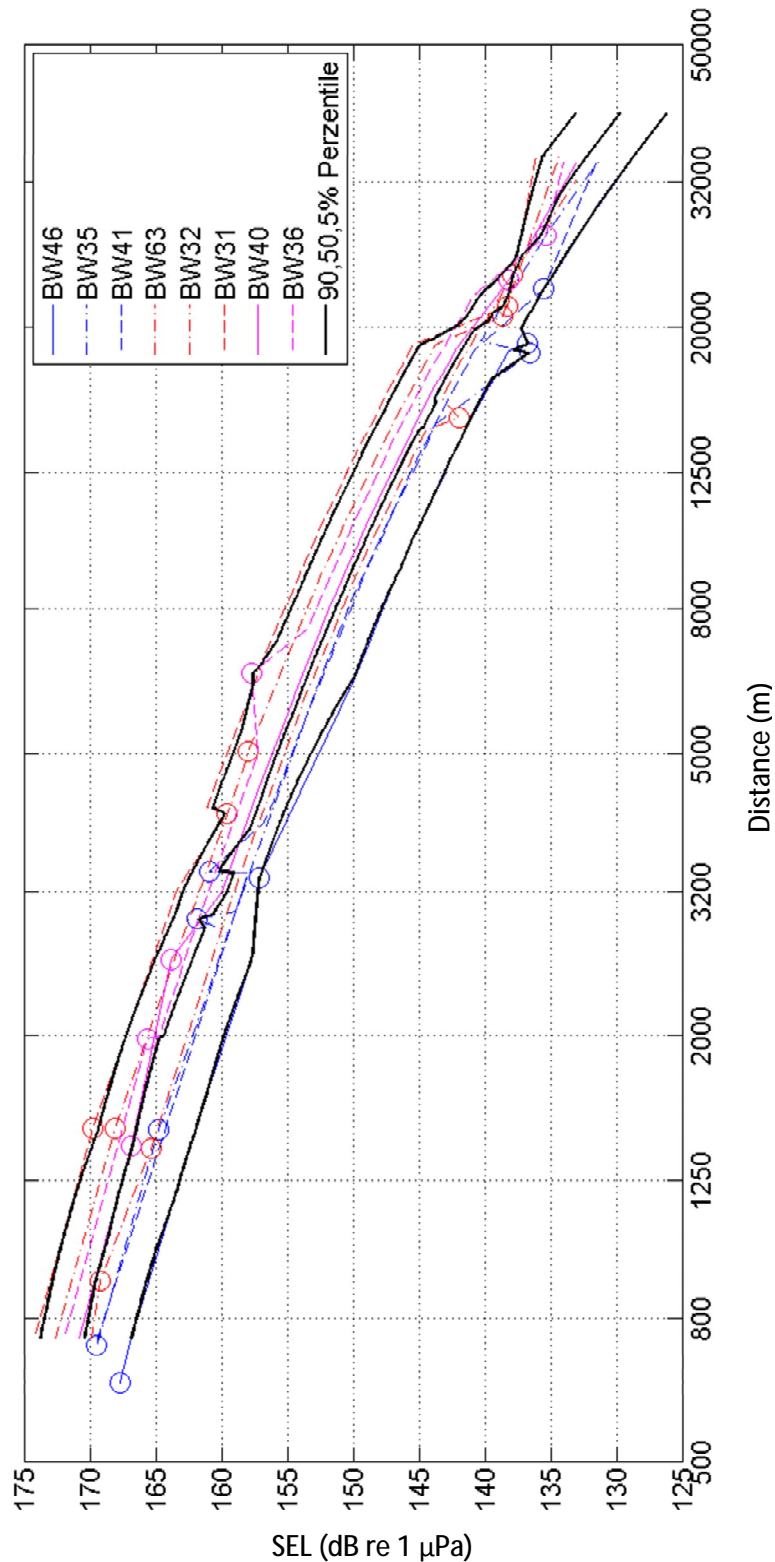

Fig. 2-6: Predicted SEL_{50} values at Trianel Windpark Borkum, Phase I foundation pile-drivings without sound mitigation system, based on an empiric formula of itap GmbH (coloured dotted lines) (real data: circles); furthermore shown: SEL_5 , SEL_{50} , and SEL_{90} averages over all predicted and measured values as a function of distance (black lines) (from Diederichs et al. 2014).

2.1.3 Study concept according to StUK3

According to StUK3, the study was subdivided into three phases:

- Phase I: Baseline survey (11/02/2008 to 24/07/2008).
- Phase II: Construction phase (25/07/2008 to 14/12/2009):
 - Transformer station (18/09/2008 to 25/09/2008);
 - Turbine foundations (23/04/2009 to 23/08/2009):
 - § Tripod (Multibrid) (24/04/2009 to 01/06/2009);
 - § Jacket (Repower) (15/06/2009 to 26/08/2009).
- Phase III: Operation phase (15/12/2009 to 02/05/2013):
 - First year of operation (15/12/2009 to 31/12/2010);
 - Second year of operation (01/01/2011 to 31/12/2011); Trianel Windpark Borkum, Phase I pile-drivings (03/09/2011 to 21/11/2011);
 - Third year of operation (01/01/2012 to 31/12/2012); Trianel Windpark Borkum, Phase I pile-drivings (28/01/2012 to 28/03/2012);
 - Fourth year of operation (01/01/2013 to 02/05/2013); often combined with 2012.

The investigations of marine mammals were based on three methods, in accordance with StUK3 (BSH 2007): Line-transect observations by aerial surveys (visual and HiDef digital) and vessel-based surveys, as well as registrations by passive acoustic monitoring (PAM) via porpoise detectors (PODs). Visual aerial surveys were split into mammal (altitude 183 m) and combined mammal/bird (altitude 76 m) survey flights. Well-grounded deviations from StUK3 were carried out in agreement with the German Federal Maritime and Hydrographic Agency (BSH).

Numbers, abundance, and distribution of marine mammals were mainly assessed by visual aerial and vessel-based surveys. The former covered an area of 2,048 km² between two traffic separation schemes (Fig. 2-1) by 22 north-south transects with a total length of 520 km. The windfarm area was crossed at a length of 1.5 km. Due to slower speed, vessel-based surveys covered an area of only 475 km² by eleven North-to-South transects with a total length of 156 km.

Habitat use of harbour porpoises was recorded by using porpoise detectors (PODs) positioned in a range of 20 km around the construction site at 12 stations. PODs record echolocation clicks of harbour porpoise at a range of about 200 m. The positions of some stations were shifted during the project due to logistic constraints. A swap of the device type was conducted in the first year of wind-farm operation (Section 2.4.2). T-PODs (p. 27) were used during the Baseline survey (Phase I) and the Construction phase (Phase II). As from the first year of the Operation phase (Phase III) a newer device type, the C-POD (p. 28), was introduced since T-PODs were not supported anymore by the manufacturer Chelonia Ltd. In order to allow comparisons of data from both device types and to assess a correction factor (p. 133), these were partly deployed together (Section 2.4.2).

Due to rapid developments in statistical methodology, most analyses were performed by more advanced methods than described in StUK3, and in accordance with the methodology recommended in StUK4 (BSH 2013).

2.1.4 Phase I: Baseline survey

According to StUK3, a two-year baseline survey has to be conducted prior to offshore windfarm construction. In agreement with the BSH, the baseline survey was shorter than one year and took place in 2008 (Diederichs et al. 2008a). Data from Phase I served as a reference for datasets obtained during Phase II and III.

Five marine mammal and nine mammal/bird visual aerial survey flights (Section 2.2), as well as nine combined mammal/bird vessel-based surveys (Section 2.3.1) were conducted before construction activities started. As for the acoustic survey, 12 T-PODs were deployed from 15th of March to 24th of July, 2008 (Section 2.4.4). StUK3 requirements were met with all methods.

2.1.5 Phase II: Construction phase

After StUK3, marine mammal occurrence, behaviour, and harbour porpoise habitat use had to be monitored throughout the construction phase, which had been effected accordingly. Phase II was characterised by high sound emissions from pile driving at certain times. High sound levels were supposed to have adverse effects on harbour porpoises. Therefore, the construction phase was the phase during which a displacement of animals was most likely to be detected.

Pile driving for construction of the transformer station and the 12 wind turbine foundations took place between 18th of September, 2008 and 26th of August, 2009. However, first construction vessels arrived in the area already on 24th of July, 2008, and a certain period after pile-driving was included into the construction phase as well, resulting in a time range of Phase II from end of July 2008 to December 2009.

A total of 12 mammal and 11 mammal/bird visual aerial survey flights (Section 2.2), as well as 19 combined mammal/bird vessel-based surveys (Section 2.3.1) were conducted throughout the Construction phase, meeting the requirements of StUK3. As for the acoustic survey, again 12 T-PODs were deployed during this period (Section 2.4.4). Due to logistic constraints their positions were partly moved referred to Phase I. While the generalised detection rate *Porpoise Positive time unit per time unit*, extracted from POD data, was analysed with all three phases, the parameter *Waiting time* (p. 34) was only meaningful with Phase II analyses.

2.1.6 Phase III: Operation phase

According to StUK3, the impact of operational activities on the abundance and habitat use (e.g., frequency, presence at various distances from wind turbines) of marine mammals in the assessment area had to be monitored for at least three years. These requirements were met here.

Phase III started at 15th December, 2009. As from September 2011, pile driving activities for the offshore windfarm Trianel Windpark Borkum, Phase I (BW2) started in the vicinity (8-15 km west) of alpha ventus. Since pile driving for BW2 took place close enough to influence harbour porpoise activity patterns in 2011 and 2012, the outcome of some Phase III analyses for project alpha ventus may have been affected. Times of pile-driving activities for Trianel Windpark Borkum, Phase I are listed in Diederichs et al. (2014).

A total of 30 mammal and 30 combined mammal/bird visual aerial survey flights (Section 0), two aerial HiDef digital video surveys, and 77 combined mammal/bird vessel-based surveys (Section 2.3.1) were conducted throughout the operation phase, fully meeting the requirements of StUK3. Twelve PODs were deployed during Phase III (Section 2.4.4). Two positions were moved into the windfarm area in spring 2012.

2.1.7 Deterrence

Pile-driving phases were accompanied by deterrence of marine mammals according to a special deterrence concept developed in view of the construction works for alpha ventus. It required the operation of two pingers (aiming at harbour porpoises) and a seal scarer (aiming at seals, but also deterring porpoises) on board of the floating crane *Samson* from 30 minutes before pile driving started until the end of pile-driving (Nehls 2008). However, deterrence was not always conducted according to the concept, complicating the analyses of detection rates. Deviations and further details are provided by Diederichs et al. (2010). General information on deterrence procedures is presented by Gordon et al. (2007).

Since the study was not specifically designed to investigate the effects of deterrence on the activity patterns of marine mammals, no statistical results are presented regarding the efficiency of the deterrence procedure. As a general result, only few harbour porpoises were detected close to an OWT while deterrence was operating, with lowest values during pile-driving activities (Diederichs et al. 2010). Since effects of pile-driving with and without deterrence on observations and detection rates of marine mammals were difficult to disentangle, these effects will be concatenated in the analyses of the presented final report. This means that avoidance effects of porpoises during pile driving are a result of both, pile driving and deterrence devices and it cannot be decided, to which extent either noise from piling or from deterrence devices scaring the animals away from the construction site.

2.2 Aerial surveys

Since the early nineties of the last century, population numbers of harbour porpoises in the Baltic Sea and North Sea have been monitored using defined linear transect methods (Hammond 1986; Buckland et al. 1993, 2001). Due to their efficiency and comparably low costs, visual aerial transect surveys were the preferred method to cover large areas of coastal waters (Gunlaugsson et al. 1988; Heide-Jørgensen et al. 1992, 1993; Hammond et al. 1995; Adlung et al. 1997; Diederichs et al. 2002; Grünkorn et al. 2004; Scheidat et al. 2003, 2004; Thomsen et al. 2004; Gilles et al. 2006, 2007). Validity and efficiency of this method led to mandatory flight transect surveys, both for data collection for the designation of future conservation areas, and for the approval of offshore windfarms in the North Sea and Baltic Sea (BSH 2007). A detailed description of the methodology for visual aerial surveys can be found in Diederichs et al. (2002) and Thomsen et al. (2004).

Recently, a new method came up in this field: HiDef digital aerial surveys (Thaxter & Burton 2009). We made use of HiDef digital aerial surveys during the last month of the project.

In contrast to the continuous but small-scale character of passive acoustic monitoring, aerial and vessel-based surveys are to be regarded as regional-scale *snapshot* studies especially prone to

short-term fluctuations of the variables involved (e.g., seastate, daytime, patchiness of animals). Hence, the data of these surveys are much more variable and offer only moderate potential for generalisation. Aerial survey data again are less prone to variation than vessel-based survey data, and allow the calculation of densities. Especially aerial surveys provide valuable information to supplement local PAM data in order to get a deeper understanding of distribution patterns.

2.2.1 Visual aerial surveys

For the collection of data, visual aerial surveys were conducted at two altitudes (183 m and 76 m). No changes in flight altitudes had to be made with regards to the erected turbines because the transect lines were crossing the windfarms within the turbine rows. The altitude of 183 m above sea level was chosen especially for the observation of marine mammals. Due to their body length of more than one meter, individual mammals are easily detectable from higher altitudes than birds, thus a larger area can be surveyed in a shorter time, compared to lower altitudes. The second altitude of 76 m was chosen in order to survey avian species, but marine mammals were additionally recorded using the same standardised methodology. Transect parts with bad viewing conditions were defined as being invalid. Only those with viewing conditions of level 1 (good) out of three possible levels were further analysed. In addition, transect parts with a seastate above 3 (Petersen scale) were not considered for statistical analysis.

Tab. 2-3: Geographical coordinates (WGS 84: GG°MM'SS.SS'') and length of flight transects for assessment of marine mammals in the alpha ventus project area during all project phases.

Transect	Starting Waypoint Lat/Lon	Ending Waypoint Lat/Lon	Length km	Sum km
1	54° 00' 27.76'' N 006° 06' 24.86'' E	54° 05' 51.71'' N 006° 06' 24.86'' E	10.00	10.00
2	54° 06' 09.23'' N 006° 10' 13.23'' E	53° 55' 48.00'' N 006° 10' 13.23'' E	19.18	29.18
3	53° 51' 53.48'' N 006° 13' 39.23'' E	54° 06' 36.30'' N 006° 13' 39.23'' E	27.25	56.43
4	54° 06' 54.32'' N 006° 17' 08.62'' E	53° 50' 51.16'' N 006° 17' 08.62'' E	29.73	86.16
5	53° 51' 29.23'' N 006° 20' 42.32'' E	54° 07' 06.99'' N 006° 20' 42.32'' E	28.95	115.11
6	54° 07' 22.23'' N 006° 23' 52.29'' E	53° 51' 58.68'' N 006° 23' 52.29'' E	28.51	143.62
7	53° 52' 22.88'' N 006° 27' 03.83'' E	54° 07' 22.23'' N 006° 27' 03.83'' E	27.76	171.38
8	54° 07' 22.23'' N 006° 30' 33.27'' E	53° 52' 54.20'' N 006° 30' 33.27'' E	26.79	198.17
9	53° 53' 38.42'' N 006° 34' 01.47'' E	54° 07' 27.78'' N 006° 34' 01.47'' E	25.60	223.77
10	54° 07' 27.49'' N 006° 36' 41.22'' E	53° 54' 04.65'' N 006° 36' 41.22'' E	24.78	248.55
11	53° 54' 24.55'' N 006° 40' 35.24'' E	54° 07' 32.40'' N 006° 40' 35.23'' E	24.32	272.87
12	54° 07' 32.20'' N 006° 44' 03.68'' E	53° 55' 01.47'' N 006° 44' 03.68'' E	23.17	296.04
13	53° 55' 32.37'' N 006° 47' 18.72'' E	54° 07' 37.16'' N 006° 47' 18.72'' E	22.37	318.41
14	54° 07' 37.16'' N 006° 50' 42.27'' E	53° 55' 36.07'' N 006° 50' 42.27'' E	22.26	340.67
15	53° 55' 39.60'' N 006° 54' 01.58'' E	54° 07' 45.31'' N 006° 54' 01.58'' E	22.40	363.07
16	54° 07' 45.31'' N 006° 57' 27.12'' E	53° 55' 46.52'' N 006° 57' 27.12'' E	22.19	385.26
17	53° 55' 46.52'' N 007° 00' 48.21'' E	54° 07' 49.54'' N 007° 00' 48.21'' E	22.32	407.58
18	54° 07' 49.72'' N 007° 04' 09.18'' E	53° 55' 49.80'' N 007° 04' 09.18'' E	22.22	429.80
19	53° 55' 52.88'' N 007° 07' 23.64'' E	54° 07' 57.41'' N 007° 07' 23.64'' E	22.36	452.16
20	54° 07' 57.41'' N 007° 10' 50.25'' E	53° 55' 56.06'' N 007° 10' 50.25'' E	22.27	474.43
21	53° 55' 59.03'' N 007° 14' 09.34'' E	54° 07' 57.41'' N 007° 14' 09.34'' E	22.17	496.60
22	54° 07' 57.41'' N 007° 17' 41.01'' E	53° 56' 02.09'' N 007° 17' 41.01'' E	22.08	518.68

Data recording

The selected survey site spread over 2.050 km² and was split into 22 parallel longitudinal transects, each of a total length between 10 km and 30 km and a distance of 3.7 km from each other. The total transect length was approximately 520 km (Tab. 2-3, Fig. 2-7). This transect design has been agreed by the German Federal Maritime and Hydrographic Agency (BSH) on 07/04/2008.

For survey flights in 2008 and 2009, a Britten-Norman Islander BN 2 (light-utility high-wing aircraft, ten seats, twin engine) was used (Fig. 2-8). For surveys in 2010 and 2011, the same model was primarily used, supplemented by flights with a Partenavia P-68 (light-utility high-wing aircraft, six seats, twin engine). Aerial surveys in 2012 and 2013 were primarily conducted with a P-68, and to a lesser extent with a BN 2.

Flight surveys took place up to wind speeds of 3 bft (10 kn). Flight altitude was 183 m (600 ft) for marine mammal surveys, and 76 m (250 ft) for combined observational flights (marine mammals and birds). Air speed was approximately 185 km/h (100 kn).

All flights were attended by three observers. The two principal observers were seated in the left and right rear seat (windows designed as bubble windows, enabling the observers to continuously scan from 0° directly under the plane up to approximately 85°). Here and in the following sections, degree refers to the actual angle of sighting of a detected animal.

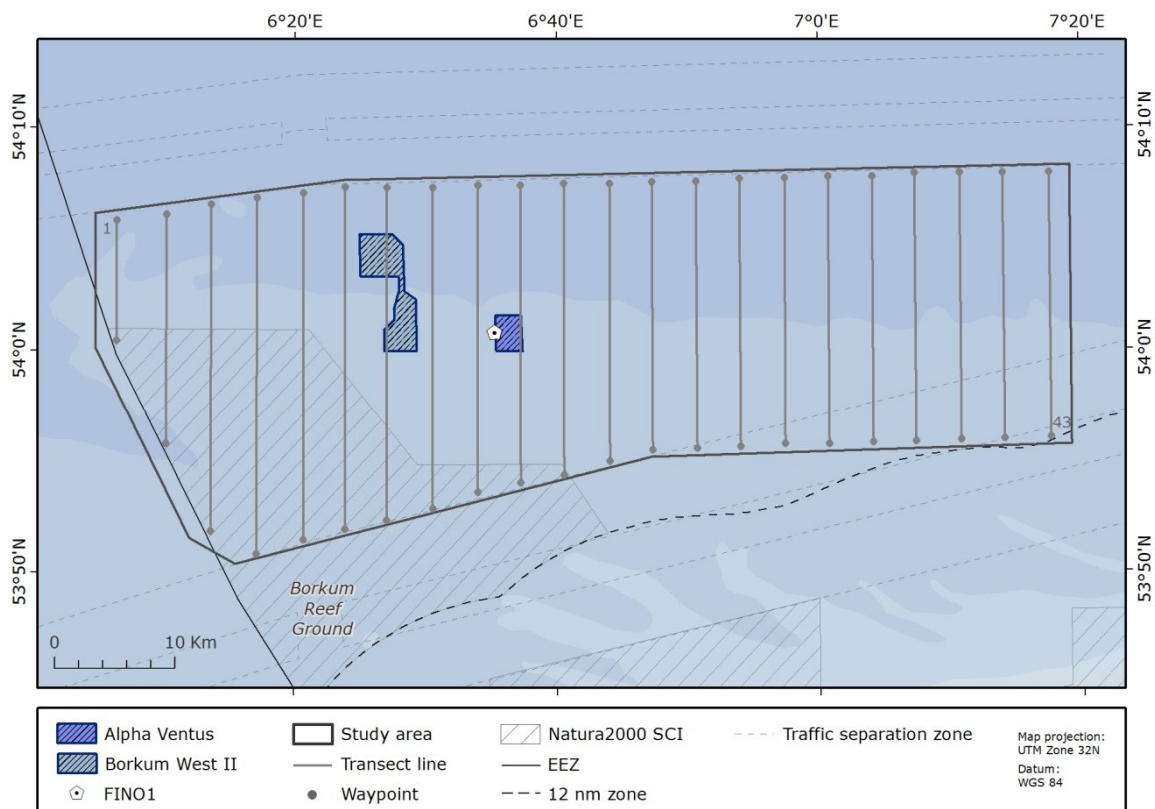

Fig. 2-7: Position of flight transects in the alpha ventus project area.



Fig. 2-8: Britten-Norman Islander, used for many aerial surveys in the project area (photo: W. Piper).

The distance between an observed individual and the transect line is directly related to the off-axis angle (Fig. 2-9). At a flight altitude of 183 m an observation in an angle of 45° equals a distance of 183 m to the transect line. Accordingly, an observational angle of 60° corresponds to a distance of 316 m, an angle of 65° to 392 m distance.

For line transect surveys, it is a crucial task to detect as many animals close to the transect line as possible (Buckland et al. 2001). Therefore, the main observers concentrated their observational efforts on an area covered by an angle up to 60° . Nevertheless, detections of marine mammals further away (angles below 60°) were also recorded. A third observer was positioned behind the pilot on the right or left hand side. This person controlled for double sightings and recorded the coverage rate of individuals close to the surface. For safety reasons, these seats were not equipped with bubble windows; therefore the third observer was only able to survey areas below an angle of 60° . This third observer was free to choose a side with optimal viewing conditions. By using earplugs and earphones all observers were acoustically isolated, causing independent count data.

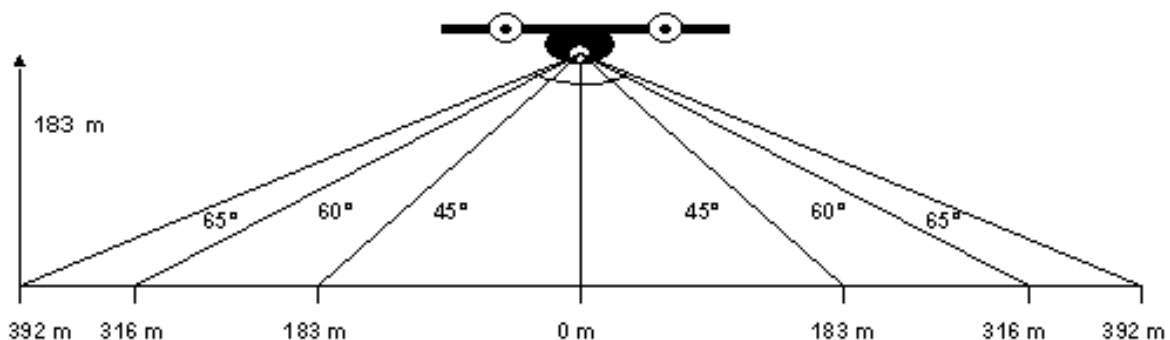

Fig. 2-9: Distance of selected view points from the transect line (0 m) in relation to view angle (shown for 183 m altitude).

Each observer sampled the respective area continuously for harbour porpoises and other marine mammals. In case of a sighting, the detection time (UTC-synchronized with onboard-GPS; Model LX 20-2000 Flight Recorder, Filser Electronics) was recorded using a voice recorder. The sighting angle was measured using a clinometer (Suunto PM-5/360 PC) and recorded as well. Additionally, group size, heading, number of offspring/calves, and any specific behaviour were recorded. After each flight, data were transferred to a database.

Flight tracks were recorded via GPS and retrieved after each flight. During the flight, a GPS recorded the transect line. Additionally, the pilot had a GPS at his/her disposal, showing the ideal transect line and the actual flight position for direct position control. After each survey, flight data were stored in .trk format in Fugawi.

Data analysis

Relative abundance

For estimating the relative abundance of marine mammals only sightings of the main observers were incorporated in the data set. Data of the control observer were only used for an estimation of double sightings. Only data of transects or parts of transects with optimal counting conditions were analysed. From here on, these transects or parts of a transect we will be referred to as „valid sections“. For every flight, the number of sightings per valid kilometer was calculated.

Density

Density calculations were performed using the software DISTANCE 6.0 R2 (Thomas et al. 2009). Calculations made by this software were based on distances (as exact as possible) between the individual sighting and the transect line. Therefore all angles obtained from the clinometer during flights were transformed into distances using the following formula:

$$X = v * \tan (90^\circ - F)$$

X = distance of sighting to transect line, v = flight altitude (m), and F = angle of sighting.

For exact population density estimates, DISTANCE makes use of the fact that the *detection probability* declines with growing distance of the detected individual from the transect line. From the detection probability a new function, the *detection function*, is calculated, using one of three models, either a uniform, a hazard rate, or a half-normal model. All calculations of population densities are based on the detection function: the *effective strip width, ESW*. The *ESW* is actually an estimate of the effective width of the surveyed transect in which all animals have been counted. This estimate is necessary for extrapolating the population densities.

Assuming an identical number of sightings, a smaller *ESW* will lead to higher population densities, compared to a larger *ESW* (see Buckland et al. 2001, Thomsen et al. 2004 for details). Densities are then calculated as:

$$D = N / ESW * L$$

Here, D = density ($ind./km^2$), ESW = effective strip width, L = total length of transect, N = number of sighted individuals.

Following Buckland et al. (2001), a minimum number of 60-80 sightings per survey is needed to calculate reliable and accurate population densities. But as long as the distribution of the sighting distances meets the above mentioned requirements, individual flights with fewer sightings can be analysed as well. However, results of small data sets can be arbitrary: some distributions meet the expectations, but the majority does not. At a workshop in St. Andrews (Scotland) in 2003 an alternative has been developed: data from single flights with few sightings are pooled, and a *global detection probability* as well as an *overall effective strip width* is calculated. These new parameters are then used to analyse the densities for single flights. By this, surveys with relatively few observations can be analysed quantitatively.

Distant-dependent distribution of harbour porpoise sightings during marine mammal aerial surveys in Phase I and II (2008 and 2009; blue bars in Fig. 2-10) met theoretical expectations of a hazard rate model (red line in Fig. 2-10; Chi square test: $p = 0.26$). The ESW amounted to 198.44 m, which was then used for density calculations.

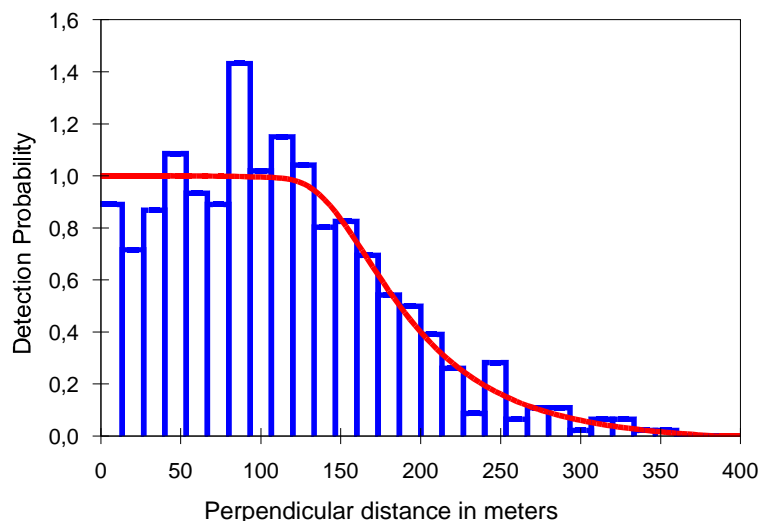

Fig. 2-10: Distance-dependent distribution of 686 harbour porpoise sightings during 17 marine mammal aerial surveys (altitude: 183 m) within Phase I and II (blue bars), with applied hazard rate model (red line).

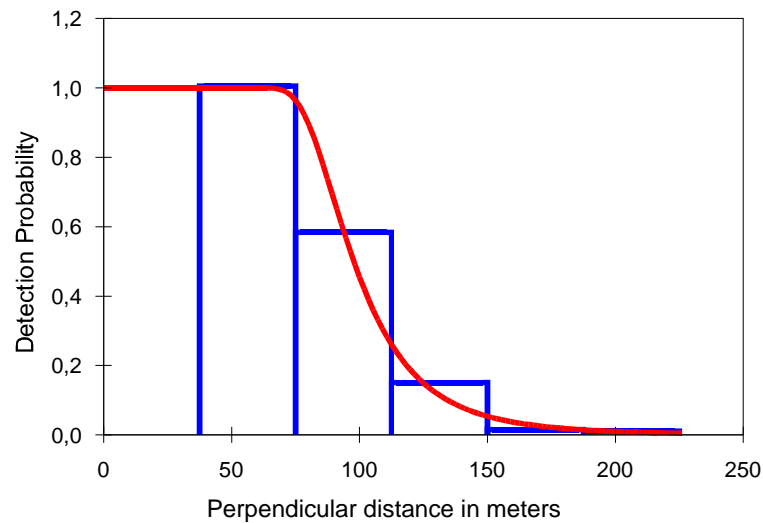

Fig. 2-11: Distance-dependent distribution of 567 harbour porpoise sightings during 19 combined marine mammal/bird survey flights (altitude: 76 m) within Phase I and II (blue bars), with applied hazard rate model (red line).

During combined marine mammal/bird survey flights in Phase I and II (2008 and 2009), distant-dependent distribution of sightings (blue bars in Fig. 2-11) followed a hazard rate model as well (red line in Fig. 2-11; Chi square test: $p = 0.53$). According to the lower altitude, the *ESW* was only 103.72 m.

Distant-dependent distribution of harbour porpoise sightings during marine mammal aerial surveys in Phase III (2010 to 2013; blue bars in Fig. 2-12) met theoretical expectations of a hazard rate model (red line in Fig. 2-12; Chi square test: $p = 0.91$). The *ESW* amounted to 185.28 m.

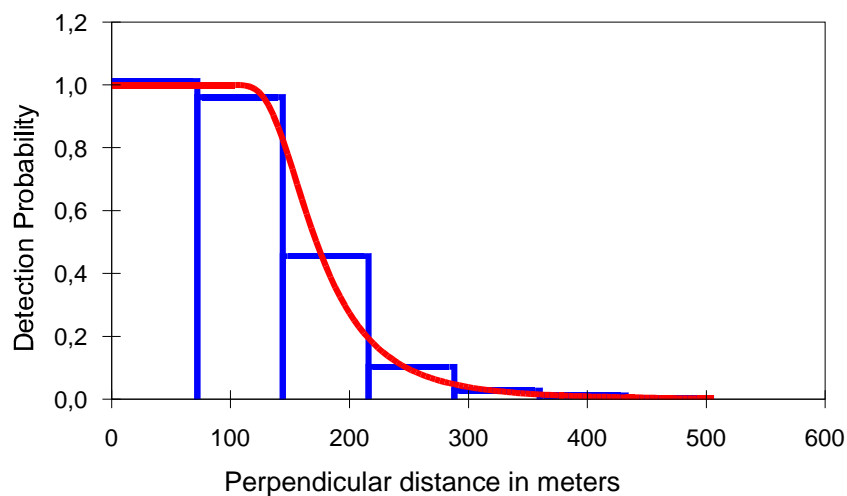

Fig. 2-12: Distance-dependent distribution of 1,250 harbour porpoise sightings during 30 marine mammal aerial surveys (altitude: 183 m) within Phase III (blue bars); red line: hazard rate model.

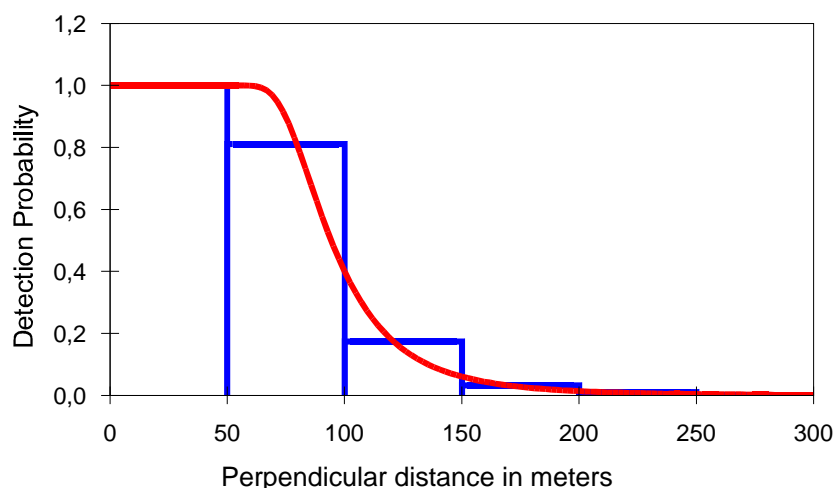

Fig. 2-13: Distance-dependent distribution of 954 harbour porpoise sightings during 30 combined marine mammal/bird aerial surveys (altitude: 76 m) within Phase III (blue bars); red line: hazard rate model.

During combined marine mammal/bird survey flights in Phase III (2010 to 2013), distant-dependent distribution of harbour porpoise sightings (blue bars in Fig. 2-13) followed a hazard rate model as well (red line in Fig. 2-13; Chi square test: $p = 0.63$). According to the lower altitude, the *ESW* amounted to only 101.47 m.

Determination of $g(0)$:

In order to calculate densities using DISTANCE, it is prerequisite that all individuals close to the transect line are actually detected. It is assumed, that the *detection probability on the transect line* (hereafter $g(0)$) is 1. Harbour porpoises and other marine mammals do not meet this requirement because a certain share of individuals is not at or close to the surface and therefore not recordable (the so called *detection bias* (Borchers et al. 2002); sometimes termed *availability bias*). Furthermore, there is a certain chance that animals at the surface are missed by the observers: the so called *perception bias* (Borchers et al. 2002).

The *corrected density* (after Borchers et al. 2002) is therefore calculated as:

$$D = D_e * 1 / g(0)$$

D = corrected density, and D_e = estimated density without correction.

For estimating D we need a proper calculation of $g(0)$, combining the perception bias and the detection bias. This method was first used by Grünkorn et al. (2004) for offshore surveys off the coast of Sylt. Based on 22 flight surveys (years 2001-2002), a $g(0)$ of 0.3 was calculated. We first need to calculate the perception bias, which is best done using data of sightings and re-sightings of two observers for the same area. For this study, main observers and control observers were seated at different windows allowing the coverage of different angles and thus areas of variable size. Therefore, only detections of main and control observers in an angle of 20° - 45° were com-

pared, resembling areas equally visible from both positions in the plane. The *perception probability* is hence calculated as Borchers et al. (2002):

$$W(\text{main observer}) = n_{12} / n_1 = \text{Nr of double sightings} / \text{Nr of sightings control observer}$$

W = perception probability of the main observer.

(Example: If the control observer detects 14 individuals and the main observers identify eight of these, the main observers' perception probability would be 0.57.)

The *detection bias* was calculated using literature data on the actual surface time of the target species. According to Westgate et al. (1995) harbour porpoises off the east coast of Canada and the United States showed a mean probability of 43% to stay at the surface in depths of 0 to 1 meter.

Teilmann and his co-authors used satellite telemetry and trip recorders to show that harbour porpoises in the Danish Belt Sea stayed at surface between 39% and 55% of their time budget, with an annual mean of 44% (Teilmann et al. 1997, 2001; Teilmann 2000). Yet, there was seasonal variation in the data: while in April animals stayed 55% of their time at the surface, from May to August only 39% to 44% of the time was spent with swimming at the surface. This resulted in a factor of 2-3 (depending on the month in which the survey was performed) to multiply the observed number of animals with, in order to calculate the actual number of individuals present.

A preliminary analysis of the data showed an insufficient number of sightings by the control observer in many cases, therefore no *flight-specific* $g(0)$ could be calculated. Instead, a *global* $g(0)$ over all flights was calculated (see Hammond et al. 1995, Scheidat et al. 2004, and Gilles et al. 2007 for details). This was done by assessing the *perception bias* for all main observers by dividing the sum of all double sighting by the sum of all sightings of the control observer.

The *detection bias* was determined by multiplying the number of sightings in valid sections per flight by the respective month-specific *surface times* (from Teilmann 2000). If no month specific data on surface times were available, the annual mean or the mean of the adjacent months was used.

The cumulative *perception probability* (between 0 and 1) multiplied by proportional *surface times* (between 0 and 1) resulted in $g(0)$ values finally used with all subsequent density calculations.

Spatial distribution of densities

The time of each sighting was recorded by the main observers using watches synchronized with the onboard GPS. Observational data and data of the flight path were linked together in a database and GIS compatible datasets were produced to map the spatial and temporal data.

Observations of the control observers were not included into the cartographic reports since these were only used for the estimation of the correction factor. Cartographic analyses were corrected for effort. Only sightings in valid sections of transects were charted.

In order to evaluate phase differences and phenological trends of harbour porpoise densities in spatial detail, the total aerial survey area was split into two subareas ('Aerial West' and 'Aerial

East’; see Fig. 2-14). The western part included the Natura 2000 SCI DE 2104301 “Borkum Riffgrund” (= “Borkum Reef Ground”), the eastern part included the windfarm alpha ventus and the area east of it.

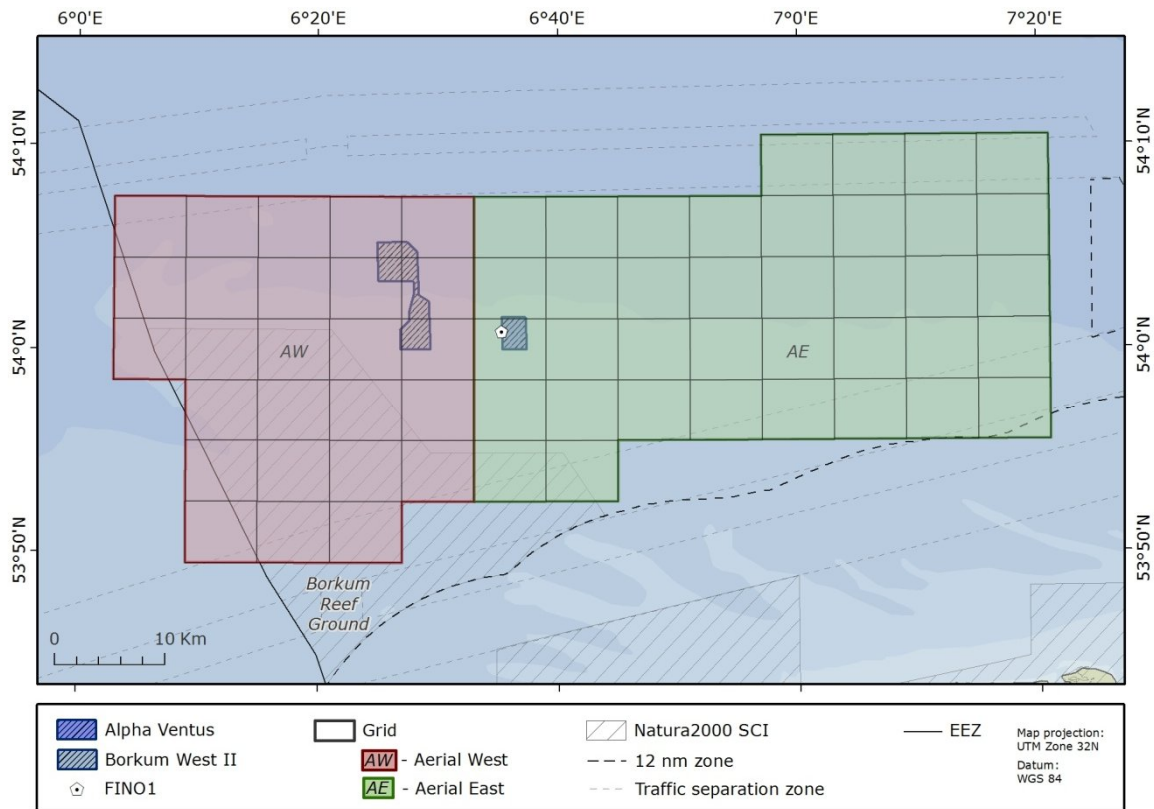

Fig. 2-14: Spatial subdivision of the aerial survey area into subareas ‘Aerial West’ and ‘Aerial East’.

Proportion of calves

Harbour porpoises of German coastal regions give birth to their offspring between May and July (Adelung et al. 1997). At parturition, neonates are between 70 and 90 cm, thus often reaching more than half of their mothers’ body length. (Adelung et al. 1997, Prochnow 1998). During the first six months, offspring growth rates are high. Newborns gain additional 25% off their initial body weight in these months. Thus, within a reasonable time of a few months, differences in size between adults and offspring diminish, making it hard to securely identify a mother and offspring combination in any group of two harbour porpoises (Prochnow 1998). In this study, sighted harbour porpoises were classified into two groups, adults and calves (calves had to be considerably smaller than adults to be classified as calves). The proportion of calves was calculated as number of calves relative to the sum of all sighted individuals.

Effects of pile driving

Harbour porpoise densities of five survey days with and six days without pile-driving of the months June to August in 2008 and 2009 were tested for significant differences by a non-parametric Wilcoxon-Mann-Whitney test (U test). Densities were calculated separately for each survey flight, subdivided by three subareas each of 327 km²: 1) The central ‘Impact Area’; 2) ‘Ref-

erence West', 6 km west of the 'Impact Area'; 3) 'Reference East', 6 km east of the 'Impact Area' (Fig. 2-15). Densities within these subareas at pile-driving days were tested for significant differences by a non-parametric Friedman test.

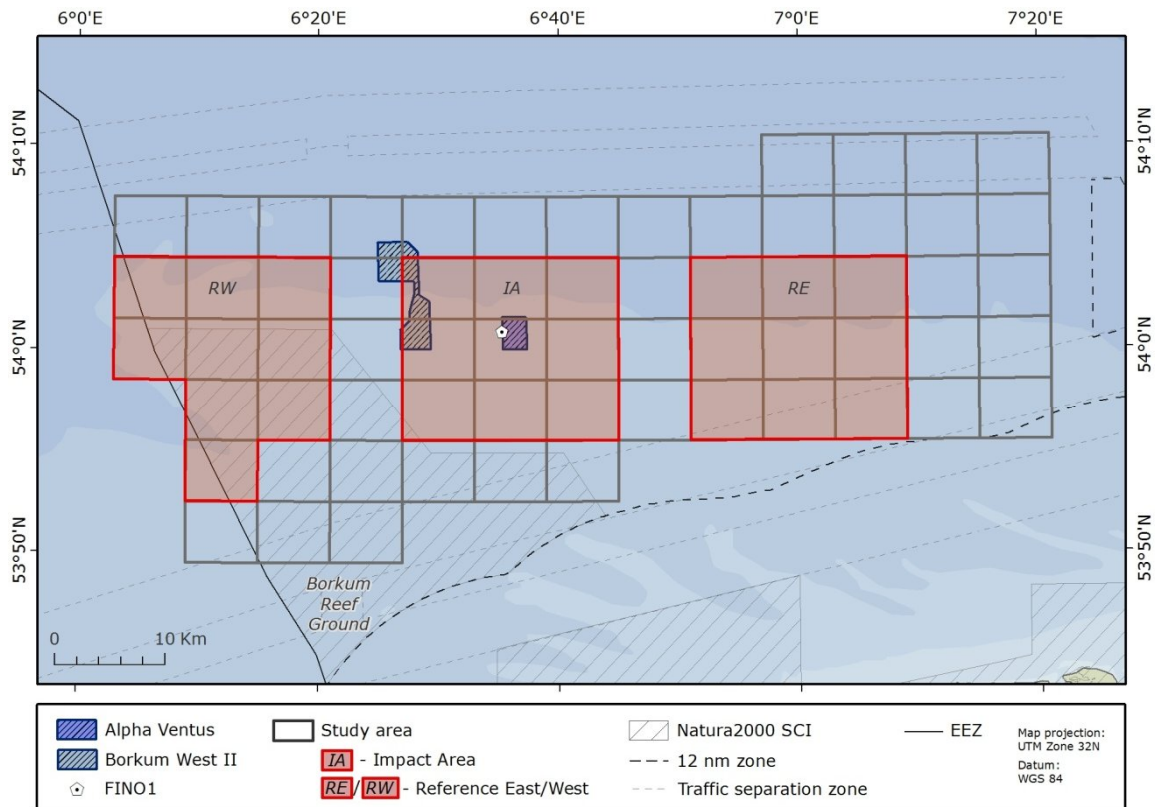

Fig. 2-15: Position of subareas selected for testing for effects of pile-driving on harbour porpoise densities within the total area of aerial surveys (left to right: 'Reference West', 'Impact Area', 'Reference East').

2.2.2 HiDef digital aerial surveys

Due to safety reasons and the fact that digital survey methods have considerably advanced over the last years it was decided in STUK 4 to replace visual surveys with observers by digital video or photo techniques. Digital techniques have the advantage to fly at great heights well above offshore windfarms and to allow double-check and QA of obtained data making the whole process transparent to third parties. Concerning the change in method it has been asked how data from digital surveys will be comparable to the data from more than a decade of visual surveys obtained in EIA studies for German offshore windfarms. It was thus decided to complement the monitoring of birds and marine mammals at alpha ventus with two digital surveys in spring 2013. It was decided to commission the company HiDef (<http://www.hidefsurveying.co.uk/>) to conduct two video surveys. HiDef digital aerial surveys of marine mammals consisted of four phases:

Survey flight and data collection

The airborne component of the HiDef system incorporated multiple digital cameras which can be used with varying resolutions and data management equipment. A rig comprising four standard

HiDef cameras with sensors were oriented at 30° to vertical and set to a Ground Spatial Resolution (GSR) of 2 cm. Within the project area, the same linear transects as for visual aerial surveys were surveyed (Fig. 3-12). Each transect consisted of a set of smaller parallel transects separated by a gap. During a transect, each camera sampled a strip of 125 m width, separated from the next camera by approximately 20 m, thus providing a combined sample width of 500 m within a 560 m overall strip. Surveys were flown at an altitude of 549 m. Position data for the aircraft was captured from a Garmin GPSMap 296 receiver with differential GPS enabled to give 1 m precision for the positions, and recording updates in location at 1 sec intervals for later matching to mammal observations. The recorded images were stored on hard drives for further review and analysis.

Data review and object detection

HiDef raw video data were processed for further statistical analysis at a ground-based digital data review station. The survey images were viewed by trained reviewers using high definition viewing screens and an image management software package. These reviewers marked image areas requiring further analysis by experienced marine surveyors. A sample of at least 20% of the material was subjected to a 'blind' review. If the agreement in the objects detected was less than 90%, a further review of the material was initiated.

Object identification

Mammal identification within marked images was conducted by experienced marine surveyors. A sample of at least 20% of the material was selected randomly and identified independently by a separate group of experts, with a requirement of no more than 10% disagreement with the first identification of mammals.

Analysis

Two HiDef surveys were conducted (1st and 20th of April, 2013). Densities were calculated similarly to the way described for visual aerial surveys (p. 15). However, the theory of distance sampling cannot be applied since no change in detection rate in relation to the distance to the plane is assumed. No perception bias was given and the respective value set to 1. The availability bias caused by submerged animals was calculated after Teilmann (2000). The positions of registered marine mammals are visualised in maps.

2.3 Vessel-based surveys

Monitoring of birds from marine vessels followed the ESAS standards which were called for in the announcement of the "Foundation Offshore Wind Energy". During these surveys, marine mammals were recorded, using a modified observational procedure.

2.3.1 Data recording

The total area surveyed spread over 475 km² (Tab. 2-4). Altogether, twelve transects in a three kilometer spacing with an overall length of 156 km were sampled. Tab. 2-5 gives the coordinates

of all transects and the mean length per transect; Fig. 2-16 and Fig. 2-17 map the position of transects relative to the windfarm area.

For data acquisition the vessels *MV Tine Bødker*, *MV Søløven*, *MV Salling*, *MV Reykjanes*, and *MV Arne Tiselius* were engaged. At each survey two observers per side were present. Long-range observations were performed using binoculars (7x to 10x magnification). Beginning of observation intervals and single sightings were recorded on observational sheets to the minute (UTC).

Eight surveys took place during Phase I, 20 surveys were made during Phase II, and 77 surveys fell into Phase III. No surveys took place between September 2008 and February 2009 due to a postponement of foundation works into spring 2009.

Tab. 2-4: Geographical position of the two subareas ('Vessel East' and 'Vessel West') into which the total area of vessel-based surveys was subdivided, and which were used for comparisons of marine mammals distribution patterns (coordinates of corner points; WGS 84: GG°MM'SS.SS').

	Latitude N	Longitude E
Vessel East (former Impact Area: 247.16 km ²)	54° 05' 45.96''	06° 24' 30.54''
	54° 05' 45.96''	06° 40' 57.62''
	53° 58' 21.00''	06° 40' 57.62''
	53° 58' 21.00''	06° 24' 30.54''
Vessel West (former Reference Area 228.03 km ²)	54° 00' 09.00''	06° 10' 47.94''
	54° 00' 09.00''	06° 24' 30.54''
	53° 58' 21.00''	06° 24' 30.54''
	53° 58' 21.00''	06° 27' 15.06''
	53° 52' 55.20''	06° 27' 15.06''
	53° 52' 55.20''	06° 13' 32.46''
	53° 54' 09.72''	06° 10' 47.94''

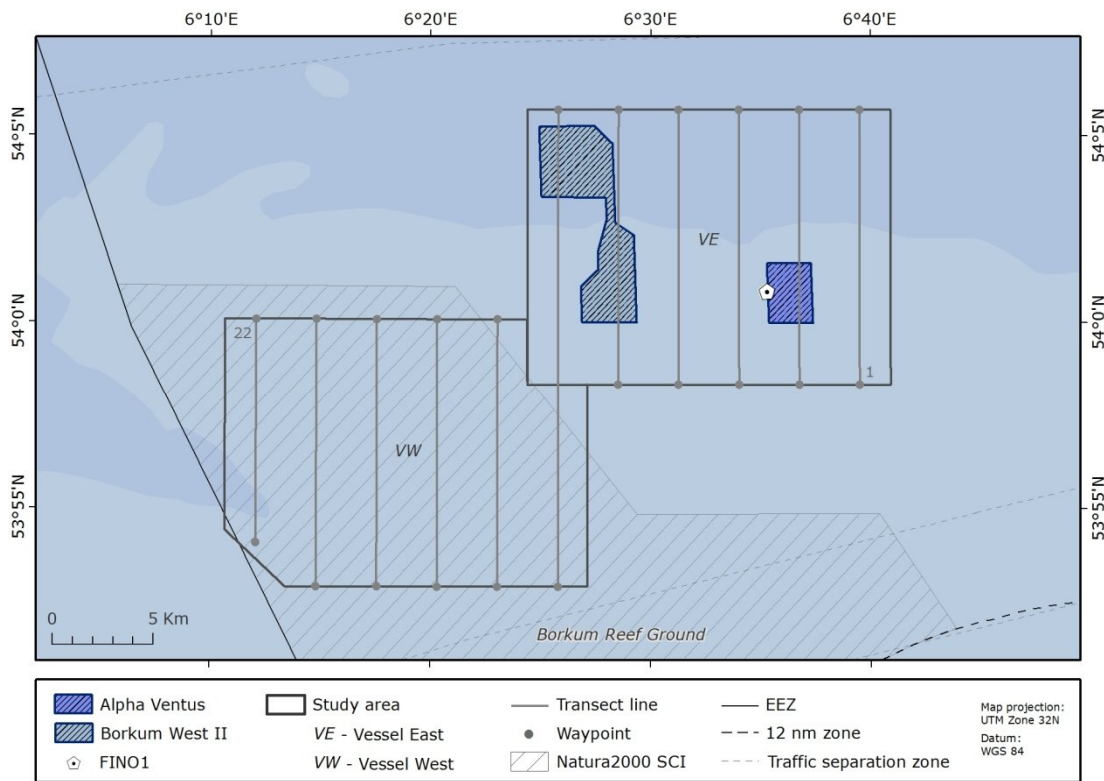

Fig. 2-16: Position of the two ship-survey subareas 'Vessel West' and 'Vessel East' relative to the test site alpha ventus; these subareas were used for comparisons of marine mammals distribution patterns over the project phases.

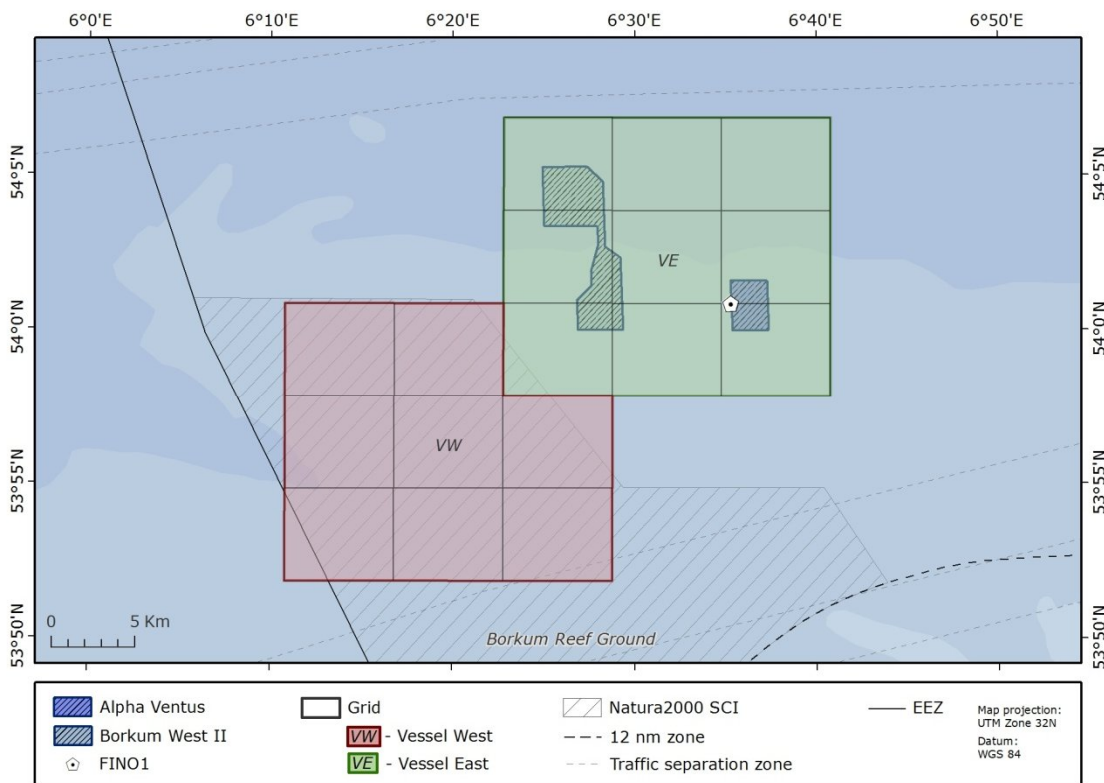

Fig. 2-17: Grid cells corresponding to vessel-based survey subareas shown in Fig. 2-16.

Data were recorded according to the standardised procedures specified in the “Seabirds-at-Sea” program. Details can be found in the methodological section of the ornithological reports (e.g., Piper et al. 2008). Harbour porpoises and seals were registered by using specific data sheets. For each detection, time, species, quantity, age, behaviour, distance to the ship, and heading were recorded.

Tab. 2-5: Geographical coordinates of the ship transects (VW = Vessel West, VE = Vessel East; chart datum: WGS 84: GG°MM'SS').

Area	Transect	Starting Waypoint Lat/Lon	Ending Waypoint Lat/Lon	Length km
VW	1	54° 00' 06" N 006° 12' 05" E	53° 54' 07" N 006° 12' 05" E	11.09
	2	53° 52' 56" N 006° 14' 50" E	54° 00' 06" N 006° 14' 50" E	13.27
	3	54° 00' 06" N 006° 17' 34" E	53° 52' 56" N 006° 17' 34" E	13.27
	4	53° 52' 56" N 006° 20' 19" E	54° 00' 06" N 006° 20' 19" E	13.27
	5	54° 00' 06" N 006° 23' 03" E	53° 52' 56" N 006° 23' 03" E	13.27
VW/VE	6	53° 52' 56" N 006° 25' 48" E	54° 05' 42" N 006° 25' 48" E	23.65
VE	7	54° 05' 42" N 006° 28' 33" E	53° 58' 21" N 006° 28' 33" E	13.61
	8	53° 58' 21" N 006° 31' 17" E	54° 05' 42" N 006° 31' 17" E	13.61
	9	54° 05' 42" N 006° 34' 02" E	53° 58' 21" N 006° 34' 02" E	13.61
	10	53° 58' 21" N 006° 36' 46" E	54° 05' 42" N 006° 36' 46" E	13.61
	11	54° 05' 42" N 006° 39' 31" E	53° 58' 21" N 006° 39' 31" E	13.61

2.3.2 Data analysis

Mammal and bird surveys from board of marine vessels differed in their methodological procedures, leading to different statistical data analysis. A harbour porpoise observation was regarded reliable only at moderate weather conditions with wind speed up to 2-3 bft. At higher wind speeds, animals are easily obstructed by waves, and a large quantity of individuals might have been missed during the survey (Barlow 1988; Palka 1995; Polachek 1995; Hammond et al. 1995; Teilmann 1996). Bird surveys however, can be performed at a windspeed of up to 5 bft.

Unlike with aerial surveys, the ‘line-transect-distance-sampling’ method (Buckland et al. 2001) was not applied with vessel-based surveys due to considerable uncertainties. Observations from vessels are especially prone to seastate and visibility differences, and animals potential reaction to the ship (Buckland & Turnock 1992; Hammond et al. 1995; Teilmann 1996; Buckland et al. 2001; Teilmann et al. 2013). Instead, the analysis focussed on relative frequencies. Sightings were corrected for the effective effort (*ind./transect km*) (Evans et al. 1993; Teilmann 1996; Boran et al. 1999; Reid et al. 2003). In contrast to former mammal reports, animals in distances of more than 300 m to the vessel were included here.

2.4 Passive acoustic monitoring

2.4.1 General concept

Harbour porpoises orientate by short, high frequency clicks sounds, which they emit in order to assess their surroundings and track down prey (echolocation). Passive Acoustic Monitoring (PAM) by Porpoise Detectors (POD) makes use of this behavioural pattern by recording the click noise via hydrophone. Acoustic parameters of the PODs, defining the way how click information is transformed into digital data and saved subsequently, are to be set before use. Click sounds are emitted in frontal direction with a beam angle of 16.5° maximum (Au et al. 1999). In consequence, PODs are only able to detect porpoises if these (1) emit click sounds, (2) are within a range of 300-400 m around the hydrophone, and (3) swim in direction of the hydrophone. Registration probability is therefore strongly dependent of porpoise activity, distance, and swimming direction relative to the POD.

Harbour porpoises equipped with a hydrophone were shown to use their echolocation system almost continuously (Akamatsu et al. 2007). Hence, echolocation is assumed to be the most important sensory perception, which by its constant use allows correlation between detection rates of PODs and porpoise density in a marine area. Tougaard (2006c) and Koschinski et al. (2003) were able to demonstrate a relationship between echolocation and time-congruent observations. Tougaard (2006c) showed decreasing detection rates (porpoise-positive minutes per day) with increasing distance to the hydrophone by distance-sampling theory (Buckland et al. 2001). The concept allowed computation of a relationship between POD detection rates and porpoise densities. However, these findings have to be confirmed by further studies. A significant correlation between densities obtained by aerial surveys and POD detection rates was also observed by Diederichs et al. (2002) and Siebert & Rye (2008). Thus it is supposed that the POD detection parameter “porpoise-positive time” is a relative measure for harbour porpoise density: the higher the detection rates the more animals were present in the area.

PODs provide important information on harbour porpoises:

- a) Presence/absence of animals at a station.
- b) Relative numbers of animals at a station by assessing *Porpoise-Positive time*.
- c) Temporal utilisation intensity at a station via *Encounter time* and *Waiting time* (p. 34).
- d) Assessment of daily activity cycles via high-resolution parameters (e.g., *PPM/h*; p. 34).

Under the assumption that detection rates are not much influenced by differences between single PODs, dissimilarities between stations as well as temporal changes can be evaluated at different temporal resolutions. To achieve this goal, a calibration of PODs before use is important in order to minimise differences in sensitivity.

Field tests during project „Investigation of displacement effects of the OWFs Horns Rev, North Sea, and Nysted, Danish Baltic Sea, on harbour porpoises“ (FKZ 0329963, Diederichs et al. 2008b) revealed that usage of parameter *PP10M/day* in combination with an alternating operation of individual PODs are the best trade-off between sufficient temporal resolution and minimisation of inaccuracies due to individual sensitivity differences of devices.

Generally, PAM has the advantage to provide long-term datasets, thus giving rise to the possibility of integrating short-term fluctuations. However, this is put into perspective by the flaw that the obtained data stem from a relatively small area, since the detection range of T-PODs and C-PODs amounts to only a few hundred metres. In contrast to aerial and vessel-based surveys, PAM provides long-term, but small-scale datasets. Ideally, these methods complement each other.

2.4.2 Change in methodology from T-POD to C-POD systems

During the project a methodological change took place. From April 2010 on C-PODs (Cetacean and POrpoise Detector, Chelonia Ltd) were used instead of T-PODs (Timing POrpoise Detector, Chelonia Ltd) which were not supported by Chelonia Ltd anymore. Both device types consist of different hardware and operate with different algorithms (Section 2.4.3).

Due to this necessary shift the question arose whether it was possible to convert T-POD data into C-POD data (see Section 2.4.6). For this reason, both device types were deployed together at some stations for certain periods. Joint deployments of T-PODs and C-PODs took place from 24/04/2010 until 06/06/2010 (stations T1, T3, T6, T10; Section 2.4.4), and from 16/02/2013 until 02/05/2013 (stations T3, T5, T6, T8, T9, T10, T11; Section 2.4.4), resulting in a dataset consisting of 11 subsets of different T-POD/C-POD combinations.

A new method was developed to convert T-POD data into C-POD equivalents. Since both device types were deployed together at some stations for certain periods, it was controlled for all other variables except for operational differences between single POD devices. This opened the possibility to develop a model for calculation of a conversion factor. Such a factor was found by means of an *LME (GLS)* random-slope model, which was more suitable to the data structure than a simple linear regression model (*LM*). Since the chosen data subsets of POD combinations were treated as a random selection taken from the population of POD combinations by the chosen *LME* model, the conversion factor was applicable to other POD combinations, which was most desirable for our analyses. For comparisons, the model always had to be adapted to the respective subsample size N_{sample} . Therefore, a permutation procedure was developed for calculating confidence intervals for this subsample size. By applying the new conversion method, we were not only able to compare phenological data of all three project phases, but also to perform BACIP analyses demonstrating long-term effects of the construction and operation of OWF alpha ventus. Exact specifications of the model and its derivation are presented in the Supplements (Section 8.2.3).

2.4.3 Technical properties

T-PODs

T-PODs (Timing POrpoise Detectors; Chelonia Ltd., UK, Fig. 2-18) were used during Phase I, Phase II, and the beginning of Phase III of the project alpha ventus. T-PODs are autonomous data loggers able to recognise and record high-frequency sound events. The 'A' bandpass filter was adjusted to 130 kHz (+/-10 kHz) which is the frequency covering the main energy of harbour porpoise click sounds (Goodson & Datta 1995, Kamminga & Wiersma 1981). T-PODs consist of a plastic tube of 80 cm length with a hydrophone positioned inside at the one end directly attached to an amplifier, an electronic filter with 128 MB RAM, two battery units with six 1.5 Volt D batteries,

and a serial port for communication with a PC (Fig. 2-18). For further information on parameters see Supplements (Section 8.2.2).

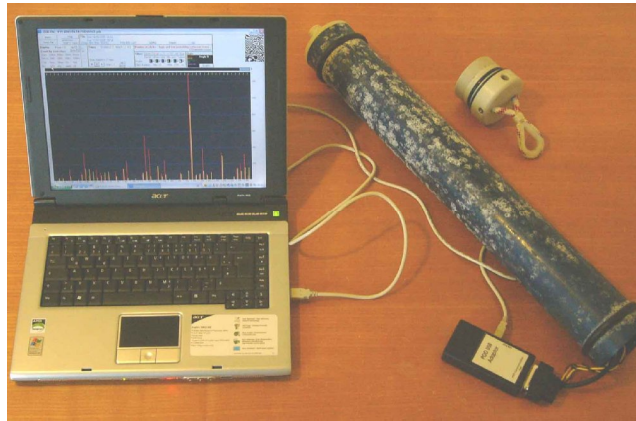

Fig. 2-18: T-POD (version 4) connected with a notebook; this configuration was used during Phase I and Phase II of the project.

C-PODs

C-PODs (Cetacean and Porpoise Detectors; Chelonia Ltd., UK; Fig. 2-19) were used during Phase III of the project. These are autonomous data loggers able to register high-frequency sound events. They consist of a plastic tube of 80 cm length with a hydrophone positioned inside at one end. Directly attached to this is an amplifier as well as an electronic filter. The hydrophone works omnidirectional, registering all sound events ranging from 20 kHz to 145 kHz (version 0). For each click, main frequency, frequency-response curve, sound duration and intensity (steps of 8 bit), as well as band width and envelope of the frequency spectrum are saved on an SD memory card (maximum 4 GB). A total of ten 1.5 Volt D batteries provide the device with energy for at least six weeks.



Fig. 2-19: C-POD (<http://www.chelonia.co.uk/index.html>) used during Phase III of the project.

All C-PODs were calibrated to equal sensitivity threshold levels (± 3 dB) according to the main frequency of harbour porpoise click sounds (130 kHz) by the manufacturer.

2.4.4 POD stations and station clusters

Mostly, 12 POD stations were in use during the project (see Fig. 2-1). However, due to logistic constraints some T-POD/C-POD positions were subject to change during the course of the project (Diederichs et al. 2008a, 2009a, 2009b, 2010; Höschle et al. 2011; Hansen et al. 2013), being a challenge for statistical analyses across phases.

Since the 12 POD positions of the Construction phase in 2009 (Diederichs et al. 2010) were in use for the longest time span (ten of these were also used in the years 2010 to 2013 of Phase III), these were indexed by T1 to T12 for the final report (conforming with Diederichs et al. 2009b, 2010; Höschle et al. 2011; Hansen et al. 2013). Stations indexed by T1 to T12 in earlier reports (Diederichs et al. 2008a, 2009a) were not always congruent with equally indexed stations of this report. We therefore decided to re-index the stations of earlier reports in order to clarify positional changes (Tab. 2-6). Furthermore, stations T3 and T4 were moved into the windfarm area in spring 2012, resulting in two new stations, T3a and T4a.

Tab. 2-6: Position (WGS 84) and indexing of T-POD (T#) and C-POD (C#) stations used in this report ("Station"), and their names in former reports with years of usage ("BaseRep": Diederichs et al. 2008a; "TransfRep": Diederichs et al. 2009a; "ConstrRep": Diederichs et al. 2009b, 2010, Höschle et al. 2011, Hansen et al. 2013; "FinalConf": configuration of stations used during the unreported last years of Phase III); furthermore: distance to the next OWT ("DistOWT"; distance to pile-driving might have been up to 2 km larger; italics: stations in use before OWT construction); distance class ("DistClass"; 1: < 4 km, 2: 4-10 km, 3: > 10 km; italics: stations before OWT construction), and area ("Area"; 1: Impact Area, 2: Reference close, 3: Reference distant, 4: Borkum Reef Ground, 5: Reference Southwest, 6: Reference East; due to comparability issues clusters 5 and 6 were not used for area analyses).

Station	BaseRep 2008 Phase I	TransfRep 2008 Phase II	ConstrRep 2009 to 2012 Phase II, Phase III	FinalConf 2012 to 2013 Phase III	Long E (dec)	Lat N (dec)	DistOWT (km)	DistClass	Cluster
T1/C1	T1	-	T1	T1	6.58535	54.01580	0.580	1	1
T2/C2	-	T2a	T2	T2	6.60157	54.03062	1.044	1	2
T3/C3	-	T3a	T3	-	6.63108	54.00427	0.850	1	1
C3a	-	-	-	T3a	6.60702	54.00415	0.373	1	1
T4/C4	-	T4a	T4	-	6.58270	54.00495	0.803	1	1
C4a	-	-	-	T4a	6.60455	54.01792	0.424	1	1
T5/C5	-	T5a	T5	T5	6.57325	54.00638	1.377	1	2
T6/C6	-	T6a	T6	T6	6.64278	54.00477	1.567	1	2
T7/C7	-	T7a	T7	T7	6.60372	53.98703	1.500	1	2
T8/C8	-	-	T8	T8	6.60437	54.08893	7.484	2	3
T9/C9	T9	T9	T9	T9	6.34885	54.12262	19.560	3	3
T10/C10	T10	T12	T10	T10	6.35693	53.98733	15.648	3	4
T11/C11	T11	T11	T11	T11	6.51635	53.88128	14.203	3	4
T12/C12	-	-	T12	T12	6.49902	53.96393	7.459	2	5
T13	T12	T8	-(T13)	-	6.72000	54.00983	<i>6.605</i>	2	6
T14	T2	-	-	-	6.61948	54.01415	<i>0.046</i>	1	2
T15	T3	-	-	-	6.62057	54.00333	<i>0.337</i>	1	1
T16	T4	-	-	-	6.59465	54.00333	<i>0.334</i>	1	1
T17	T5	T1	-	-	6.59223	54.01443	<i>0.106</i>	1	2
T18	T6	-	-	-	6.63568	54.01097	<i>1.139</i>	1	2
T19	T7	-	-	-	6.63353	53.99507	<i>1.072</i>	1	2
T20	T8	T10	-(T8a)	-	6.62300	54.12883	<i>11.925</i>	3	3

The stations were assigned to six clusters of differing influence with regard to pile-driving activities (Tab. 2-6): 1) Impact Area, 2) Reference close, 3) Reference distant, 4) Borkum Reef Ground, 5) Reference Southwest (T12), and 6) Reference East (T13). The latter two single stations, however, were not further analysed since they were only in use at one or two phases and their positions were too different to be comparable with any POD position of the remaining phase(s). The other POD stations were due to much more decent positional change, if any, and therefore remained comparable across phases.

Different systems of distance classes were used in the former reports. Here, we relied on the system of the Construction phase report (Diederichs et al. 2010) which was best adapted to the positional changes during the project (Tab. 2-6):

- Distance class 1: < 4 km (580-3.972 m)
- Distance class 2: 4-10.2 km (7.459-10.125 m)
- Distance class 3: > 10.2 km (14.209-22.566 m)

Contrasting to analyses based on station clusters, positions T12 and T13 were included into analyses based on distance classes, since approximate congruence of positions was of minor importance here.

2.4.5 POD deployment procedure

According to manufacturer Nick Tregenza, PODs register harbour porpoise click sounds with higher probability if the devices are close to the sea floor, compared to PODs deployed at the same time near surface (Teilmann et al. 2001). In accordance with the manufacturers and our own experiences from the North Sea and Baltic Sea (Diederichs et al. 2004, 2008a), as well as from Danish investigations at offshore windfarms (Tougaard et al. 2006a,b), we deployed the PODs 5 m above sea floor with the hydrophone's angle of beam directed to the water head above.

During the project the mooring technique was modified in order to reduce the loss of devices. The mooring principle from 2009 onwards is shown in Fig. 2-20. A Herkules rope (18 mm) connects the anchor stone (600 kg) to a yellow spar buoy (6 m) on the surface equipped with a lamp (range of two nautical miles) and external radar reflector. The anchor stone is connected to a second stone (80 kg) by a ground rope (Herkules 14 mm) of 60 m length. The second stone is connected to a smaller spar buoy (3 m) with lamp and radar reflector by a Danline rope (20-24 mm) to which the POD device is attached approximately 5 m above sea floor in a way keeping it vertically in the water head. A lifting body 3 m above the POD produces the appropriate rope tension. For periodic maintenance the small spar buoy is lifted and the anchor rope is hauled up by a winch until the POD is within reach for exchange. The big anchor stone remains unmoved during POD service operation.

A mooring according to this principle was deployed at most positions. At positions within the construction area only the big yellow spar buoy was deployed whereas the second anchor had to be omitted due to safety issues (site traffic). PODs at positions T9, T10, and T11 were deployed only a few hundred metres from fairway buoys. Protected by these, a big spar buoy was unnecessary, and the whole system with only one small spar buoy was moored by two small anchor stones.

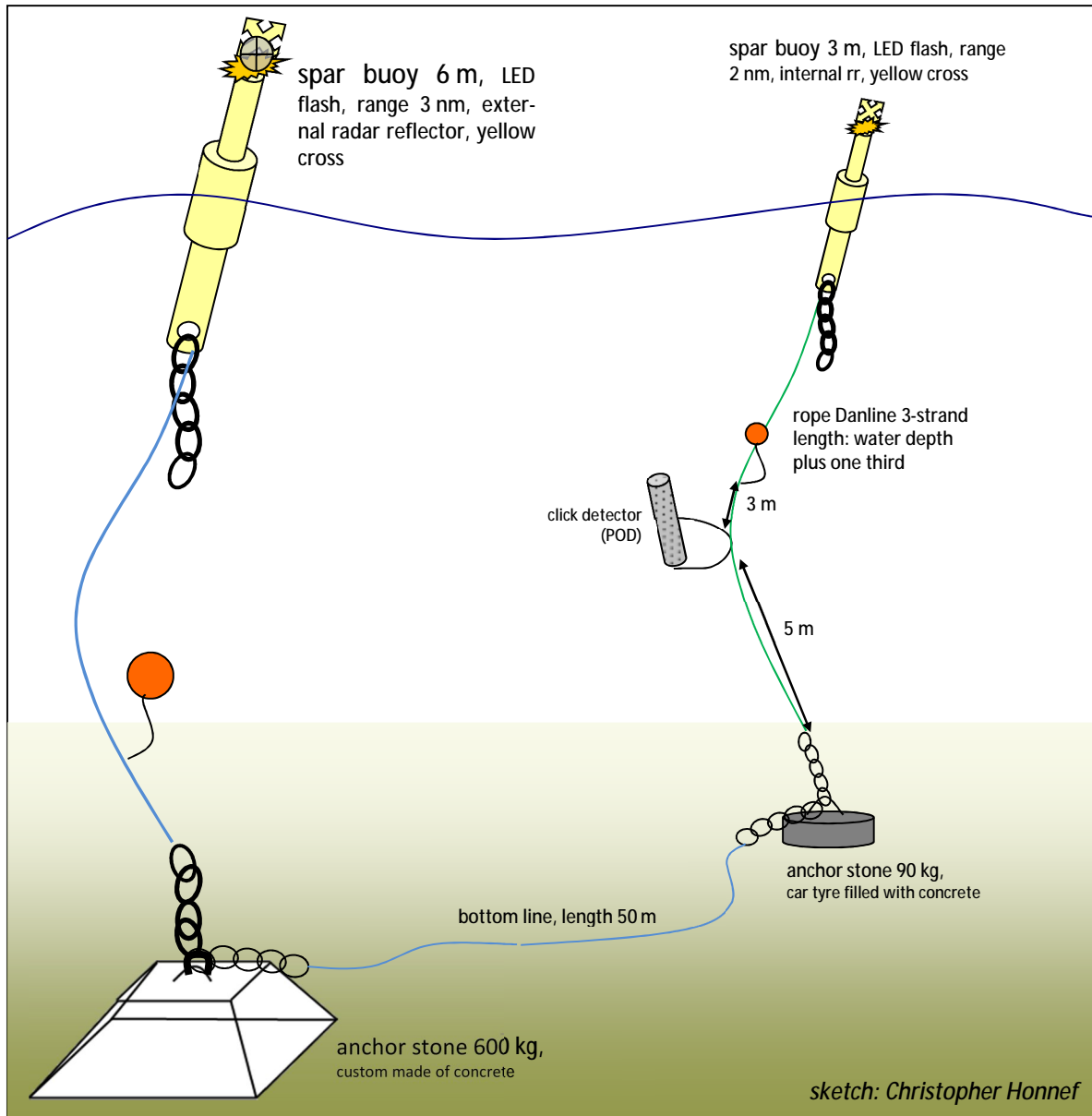

Fig. 2-20: POD system used by BioConsult SH for the alpha ventus project.

2.4.6 POD deployment periods and recording times

Whenever possible, T-PODs and/or C-PODs were deployed at 12 different stations simultaneously. Since positions of these were partly due to change, an indexing different to earlier reports had to be applied (see Section 2.4.4). The usage of different POD systems and stations at different times was visualised by a plot of POD deployment and recording times (Fig. 2-21).

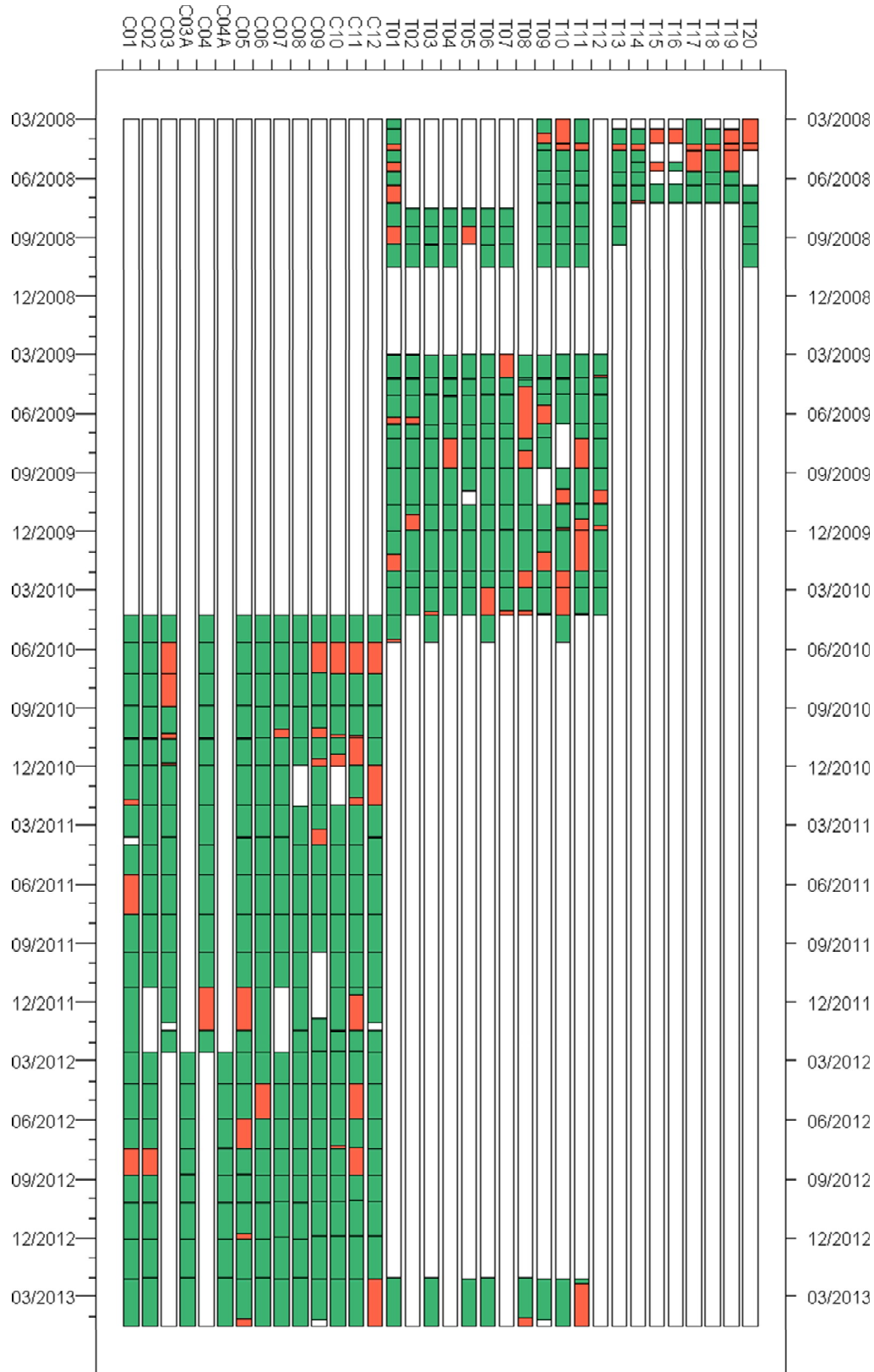

Fig. 2-21: POD deployment times in the alpha ventus area from March 2008 to May 2013; periods with analysable data in green, otherwise red; identical numbers after the device letter (C = C-POD; T = T-POD) correspond to identical positions (Section 2.4.4); in order to obtain a conversion factor both device types were used simultaneously at certain positions in spring 2010 and 2013 (see Section 2.4.7, p. 133).

2.4.7 POD data analysis

General POD data analyses

T-POD data classification

Signals were detected in real-time by T-PODs. At high temporal resolution the device was able to recognise click trains. Therefore, raw data were processed by the software TPOD.exe (for this study: version 7.41) and tested for the probability of being porpoise click sounds by internal algorithms (see Section 8.2.2). These algorithms search for certain patterns which are then classified as follows:

- a) High probability click trains ('CetHi'): Click trains with a high probability to originate from harbour porpoises.
- b) Low probability click trains ('CetLo'): Short click trains probably originating from porpoises.
- c) Doubtful click trains ('?'): Click trains with doubtful patterns which might stem from porpoises but may also come from other sound sources.
- d) Very doubtful click trains ('??'): Click trains of a probably technical origin due to their length and temporal pattern. However, it cannot be excluded that also porpoise click sounds coming from large distances or impinging onto the hydrophones from disadvantageous angles are among these trains.
- e) Boat trains ('boat'): Boat sonars are emitted at frequencies similar to those of harbour porpoise click sounds. However, they can be distinguished from these by their regular click interval. The internal algorithms recognises such regular click trains, which are then classified as 'boat'. Principally, it cannot be excluded that in very rare cases porpoise click trains may resemble the patterns of boat sonars.

Sounds not to be classified to these five categories are not shown anymore after application of the algorithm.

Only click trains of the two highest probability classes ('CetHi' and 'CetLo') were used for analyses of project data. By this, the probability of including sound events not originating from harbour porpoises into analyses was minimised. Thomsen et al. (2005) showed for captive harbour porpoises that click trains were also found in other categories. However, since we were operating in a marine area of high porpoise density where porpoise click trains were detected on a nearly daily rate in the two highest probability categories, sufficient data were available in these classes to allow for statements on presence/absence and relative densities/activities without being affected by wrong classifications. The error term regarding overseen true porpoise click trains due to the internal algorithms of TPOD.exe was assumed to be constant over all positions and hence not included with the analyses.

C-POD data classification

The classification system of C-PODs does not rely on click detection or click selection, but on train detection and classification by the 'KERNO' classifier – the 'train filter'. By means of the software CPOD.exe provided by the Chelonia Ltd. (see www.chelonia.co.uk/index.html) and its internal algorithm, the variables 'NBHF' (narrow band high frequency: used by porpoises), 'other cet' (other toothed whales: dolphins), and 'Sonar' (sonar of boats) were extracted from the raw data and filtered from background noise by the 'KERNO' classifier. The original variables were grouped into four classes according to their probability to be a real porpoise or dolphin click sound, or a sonar sound. Only the 'NBHF' probability classes 'Hi' and 'Mod' were used for further analyses. By this, the inclusion of sound events wrongly classified as porpoise click sounds into analyses was minimised. Analyses of C-POD data were conducted with CPOD.exe v2.

Parameters and definitions

For the study three main parameters (further definitions in Section 8.1) were assessed for analysing the degree of utilisation of the project area by harbour porpoises:

- a) *Porpoise-Positive 10 Minutes per day*, raw or as percentage (*PP10M/day* or *%PP10M/day*): number of blocks of ten minutes within a single day with at least one porpoise detection, in relation to the maximum of 144 for complete detection days. On days when devices were exchanged and some hours without detection occurred, the number of positive blocks was related to the actual number of blocks the POD was detecting. This low-resolution parameter was used for assessment of phenologies and differences between days before and after pile driving.
- b) *Porpoise-Positive Minutes per hour (PPM/h)*: number of blocks of one minute within a single hour, showing at least one porpoise detection. This high-resolution parameter was most suitable for assessment of the short-term response of porpoises to pile driving.
- c) *Waiting time*: Defined as the time interval between two harbour porpoise *Encounters*. The latter were defined as a series of porpoise clicks within a theoretically infinite time interval confined by time intervals of at least ten minutes without porpoise detection, which in turn were the *Waiting times* (Fig. 2-22). Hence, *Waiting times* lasted at least ten minutes. The parameter was mainly analysed for assessment of the short-term response of harbour porpoises to pile driving.

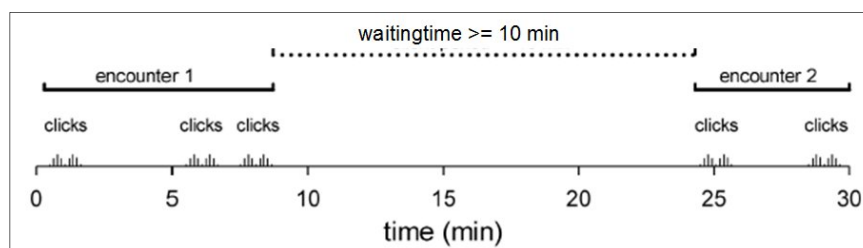

Fig. 2-22: Relationship between Encounter and Waiting time.

Phenology

C-POD data phenologies were shown to be principally comparable to T-POD assessed phenologies converted into C-POD equivalents by an *LME* model (Supplements: Section 8.2.3). Furthermore, the shape of a phenology curve was usually more interesting than absolute numbers for certain days. We used confidence intervals for phenology curves smoothed over 30, 90, 183, and 365 days (Section 3.3.1), which was the respective N_{sample} (Section 8.2.3, p. 138).

Time-series analyses were carried out by software R (package 'stats', R Development Core Team 2012). In particular, seasonal decomposition of time-series by Loess (Local polynomial regression fitting) was conducted by use of the function 'stl' (parameters: s.window=31, t.window=1095, robust=FALSE), allowing to disentangle seasonal patterns from long-term trends and short-term fluctuations.

Long-term BACIP analysis

The term 'BACI' refers to 'Before-After Control-Impact Analysis'. This kind of analysis allows statistical inference about possible differences between data recorded before (B) and after (A) an impact (I). Therefore, the impact area has to be compared with a presumably unimpacted control area (C).

The paired form of a BACI analysis, the so-called BACIP analysis, is based on differences between pairwise Control-Impact (C-I) data (e.g., C-I data measured at the same day). Here, long-term refers to the fact that Phase III measurements of impacts were conducted years after pile-driving events during the operational phase, whereas the 'Before' measurements originate from Phase I.

Having found a suitable model for estimation of C-POD out of T-POD data (p. 133), the question raised whether the obtained conversion factor would be usable with BACIP (= Paired BACI) analyses. The BACIP approach is rather strict in its methodological assumptions. Using converted T-POD data for the 'Before' part (B), and C-POD data for the 'After' part (A) caused some problems here. Assessment of significant differences between Before-windfarm-construction and After-windfarm-construction detection rates *PP10M/day* was only possible when considering the N_{sample} -corrected confidence intervals of the conversion factor *b* (Supplements: Section 8.2.3, p. 138).

The BACIP procedure regarding converted T-POD data included the following steps: Both for Before- and After-*PP10M/day* values, differences between Control and Impact were calculated (this was done pairwise: e.g., for Control and Impact data of the same day):

$$D_{Ai} = A_{(C-I)i}, \text{ respectively } D_{Bi,mean} = B_{(C_{mean}-I_{mean})i}$$

D stands for difference; *i* represents a certain value within a subsample of N_{sample} data (e.g., *PP10M/day* values of a day within a month or year before/after construction work). Differences between Control and Impact (D_{Bi}) for converted T-POD data (which in case of this study would be the Before dataset, B) were calculated for nine cases: between the lower confidence level, upper confidence level, and mean of Control and Impact, respectively. The After dataset (A) of differences between Control and Impact, D_{Ai} , had to be tested against each of the nine D_{Bi} datasets by a Wilcoxon-Mann-Whitney rank sum test for paired data (Software WinSTAT v2009.1). All nine re-

sults had to be consistent for meaningful interpretation. If this was not the case, statistical inference became more complicated.

In detail, the three 'Impact Area' stations were chosen as Impact, the two 'Borkum Reef Ground' stations served as Control. Both station clusters were congruently sampled at 118 calendar days of the years 2008 to 2012. Since one assumption of BACIP is an independence of Before-After pair-by-time combinations, we chose 43 calendarly days between 2nd of May and 10th of September that were intermitted by at least one full day. This could not fully eliminate the independence problem, but at least minimised short-term autocorrelation of data, with a sufficient number of combinations left for non-parametric testing. In order to calculate confidence intervals by permutation, the parameter N_{sample} was obtained by multiplying the number of pair-by-time combinations by the number of stations per project area ($N_{sample} = 129$ for Impact; $N_{sample} = 86$ for Control). The four tests to be conducted (2008 vs 2009-2012) were planned a priori and therefore regarded as planned contrasts. Hence, no adjustment of the significance level ($\alpha = 5\%$) according to multiple testing had to be performed. This was also valid for the nine parallel tests needed for each of the comparisons of the 2008 vs. 2010-2012 data, since these nine tests were part of one of the four tests.

Phase I analyses

Since data obtained during Phase I were used as a baseline for impact analyses, no computations were conducted with these data exclusively. Instead, these were included as reference into general POD data analyses (p. 33) and BACIP/BACI analyses (p. 35, p. 38).

Phase II analyses

Daily resolution: PP10M/day

The direct effect of pile-driving on daily harbour porpoise detection rates (*PP10M/day*) was analysed by means of Generalised Additive Modeling (*GAM*). *GAMs* (Hastie & Tibshirani 1990) allow to model expected values E of a response variable Y (here: *PP10M/day*) by one or more predictor variables (co-variables X_1 bis X_n). In contrast to Linear Models (*LM*) or Generalised Linear Models (*GLM*), both parametric and non-parametric functions are allowed for modelling single co-variables; these submodels are then added as to provide an optimised estimate E for the response variable Y . For the latter a suitable distribution form can be chosen out of several distributions available with *GAMs* (e.g., quasi-poisson, binomial, normal). Besides information on the quality of the overall model, the significance of each co-variable regarding its contribution to the estimate E is indicated by a *GAM*.

Here we used non-parametric *GAMs* (Wood 2006) calculated by the free statistical software R (version 2.9.1, R Development Core Team 2007) with package *mgcv* (Wood 2004).

In order to test for the significance of an effect of pile-driving on daily harbour porpoise detection rates (*PP10M/day*) certain days (*Day X before/after piling*) were numbered according to their time lag from days when pile-driving took place (Day_0), ranging from Day_{-6} to Day_{+6} (model 1). Since only few data – furthermore coinciding with periods of exceptionally high detection rates – were available for days before pile-driving, a second model was computed only considering Day_0 to

Day₊₆ (model 2). Data were grouped into distance classes (Section 2.4.4) according to the closest distance from pile-driving of a POD station during the Construction phase.

Both types of *GAMs* were computed for each of the distance classes with *%PP10M/day* (the percentage value of *PP10M/day*) as response variable, under the assumption of a quasi-poisson distribution of *Y*. The models included the following explanatory variables: *Position* (POD position) and *Year* (2008 and 2009) as factors, as well as *Month* (with four knots, since five months were analysed) and *Pile-driving* (values from 0 to +6) as smoothing factors (with five knots).

As mentioned above, it had to be dealt with seasonal variability of harbour porpoise activity which was difficult to correct for, and which could have artificially enhanced a measured displacement effect of pile driving (pile-driving often took place in periods with generally lower porpoise activity). Therefore, we computed a control model with data from the Baseline survey in 2008. We took pile-driving times from 2009 and assigned to those the *%PP10M/day* values from corresponding times in 2008, hereby creating 'hypothetical pile-driving' in 2008, the quasi-effects of which being tested against corresponding 'hypothetical post-pile-driving' data from 2008. Models were the same as described above, except for the fact that *Year* was excluded since data were used from 2008 exclusively. A pile-driving in September 2008 was ignored here. The original and the control models were compared qualitatively in order to assess differences between them.

GAM plots were composed as follows: The mean of the model is the zero line. Significant deviations from this line – i.e., the 95% confidence intervals (CI) of the submodel for the respective explanatory variable at least partly do not include the zero line – indicate a significant influence of that variable on the outcome of the estimate *E* of the response variable *Y*.

Hourly resolution: PPM/h

Phase II effects of pile driving on a temporal resolution of hours (*PPM/h*) were analysed by means of non-parametric *GAMs*. Analogous to the analyses of daily effects, hours after *Pile-driving events* were numbered by integers from 0 (*Pile-driving phase*) to +X (Xth full hour after *Pile-driving phase*). *PPM/h* was the response variable. Explanatory variables were the factors *Position* (position of PODs) and *Year*, as well as the smoothing factors *Month* (five knots), *Hour* (time of the day), and *Pile-driving* (hour relative to *Pile-driving phase*, s.o.). Since hourly activity patterns were expected to be cyclic over a day, the option 'cyclic splines' was chosen with *Hour*. The number of knots was set to default with *Hour* and *Pile-driving*. Separate models were computed for each of the distance classes.

Waiting time

Waiting times between any two harbour porpoise *Encounters* were numbered consecutively. The *Waiting time* following a *Pile-driving event* was indexed as 1st *Waiting time*. If *Encounters* exceeded *Pile-driving events*, no 1st *Waiting time* and subsequent *Waiting times* were defined. *Waiting times* after *Pile-driving events* in 2009 were compared to hypothetical *Waiting times* in 2008. For the latter, hypothetical *Pile-driving events* were set at the same month, day, and time in 2008 as real *Pile-driving events* in 2009, and those *Waiting times* following these hypothetical *Pile-driving events* were numbered consecutively. This procedure was chosen in order to avoid the so-called 'bus paradox' (Ito et al. 2003), stating that a randomly chosen time with a higher probability falls

within the range of a long event than of a short event (e.g., time of a *Pile-driving event* with respect to *Waiting times*).

Lengths of 1st and subsequent *Waiting times* in 2009 were tested against those of hypothetical 1st and subsequent *Waiting times* in 2008 by means of a Wilcoxon-Mann-Whitney U test, in order to answer the question, if harbour porpoises were expelled from the area around pile driving.

Furthermore, we were interested in the answer to the question of how long that effect lasted. In order to quantify the minimum length of a significant negative effect of *Pile-driving events*, for each POD station the 2009 *Waiting times* with significant differences to 2008 were summed up until that *Waiting time* where no significant difference was detectable anymore. Since we were mainly interested in the pure effect duration after *Pile-driving events*, the 1st *Waiting time* was truncated and only the compartment after real and hypothetical *Pile-driving events* (*Truncated 1st Waiting time*) was incorporated into the calculation of the effect length.

All statistical analyses were conducted by software R, version 2.91 and higher (R Development Core Team 2007).

Short-term BACI analysis

The BACI (Before-After Control-Impact; see p. 35) approach aimed at the assessment of significant effects of *Pile-driving events* on the length of *Waiting times*. The After measurements were conducted shortly after *Pile-driving events* (thus short-term) in Phase II, and compared to Before measurements originating from Phase I. The most distant POD positions T9-T11 served as Control, whereas the nearby positions T1, T4, and T5 served as Impact. Data were pooled over both *Pile-driving periods* (Tripod and Jacket).

Differences between Before and After at the Control and Impact stations were tested by a Generalised Linear Model (GLM) with 'Quasi-Poisson distribution' of the *Waiting times*. In detail, it was tested for the alternative hypotheses that an increase of the 1st *Waiting time* length in 2009, compared to 2008, was significantly higher at the Impact stations, compared to the Control stations. This would be expectable if pile driving was the main cause for increased 1st *Waiting times* in 2009. The amount of the BACI effect of the 1st *Waiting time* (in minutes: mean of medians per position) was then assessed by calculating the Before-After difference in minutes at the Impact area (IA – IB = ID) minus that difference at the Control area (CA – CB = CD), by the formula:

$$\text{BACI effect} = \text{ID} - \text{CD}.$$

Phase III analyses

Methods and results of Phase III were mostly included in Section 'General POD data analyses' (2.4.7, p. 35) and Section 'Results across phases' (3.3.1, p. 59).

Effects of OWT in operation

This part was kept short since no effects of OWT in operation on harbour porpoise detection rates were found. Regarding methodology it is referred to earlier reports (Höschle et al. 2011).

3 RESULTS

3.1 Aerial surveys

3.1.1 Visual aerial surveys

Harbour porpoises

Presence and group size

Harbour porpoises were observed during all aerial surveys in the project area. Analyses of abundance and relative abundance per km (this section), as well as density (per km², and as stock in the entire project area), and proportion of calves (next three sections) included only sightings of the two main observers made in valid transect parts (see Section 2.2).

With marine mammal flights (183 m altitude), 1,936 harbour porpoise sightings with a total of 2,283 individuals were registered during 47 surveys, resulting in an average group size of 1.19 animals per sighting (Supplements: Tab. 8-5). Considerable phenological differences occurred. Most animals were observed in early spring, except for 2010 when a maximum occurred in early summer. In April and May 2008, as well as in April 2009 more animals were observed than in other months. A minimum of one animal was registered in February 2010, a maximum of 172 animals shortly before pile driving started in April 2009.

During 49 combined marine mammal/bird aerial surveys (76 m altitude), 1,521 harbour porpoise sightings with a total of 1,749 individuals were recorded, resulting in an average group size of 1.14 animals per sighting. Phenological trends similar to those of the mammal flights were found. Roughly, most animals were observed in early spring and/or early summer. A minimum of one animal was registered in January 2011, a maximum of 132 animals in May 2011 (Tab. 8-6).

Densities and numbers

Harbour porpoise densities were assessed by both types of transect flights. With marine mammal aerial transect surveys (183 m altitude), an average of 0.78 harbour porpoise individuals/km² were present in the project area of 2,048 km² across all years (Tab. 8-9).

With combined marine mammal/bird surveys (76 m altitude; Tab. 8-10) higher densities were obtained. Around 1.11 harbour porpoise individuals/km² were present in the project area on average across all years.

Spatial and seasonal distribution of densities

In order to evaluate seasonal and spatial patterns of harbour porpoise densities possibly affected by windfarm construction and operation, both types of aerial surveys were combined (Fig. 3-1 to Fig. 3-3). This procedure was valid since the method of Distance sampling allowed to correct for varying sighting probabilities due to different altitudes (Buckland et al. 2001).

Raster density maps visualised the density and distribution patterns of porpoises during spring (Feb-Apr), summer (May-Aug) and autumn (Sep-Nov) for each year from 2008 until 2012/13. For spring, surveys from 2012 and 2013 were combined. Since phase III (operation) covered three years (2010 to 2012/13), a combined raster density map over these years was also presented (Fig. 3-1; Fig. 3-2, Fig. 3-3). During May to August 2009 (when most pile-drivings took place), densities were lower, compared to summer of the other years. By contrast, only marginal differences occurred between spring 2009 (all flights before pile driving started) and of the other years (Feb-Apr; Fig. 3-1). As for the flight survey data of spring and autumn, densities seemed to increase from 2010 to 2012 (Fig. 3-1; Fig. 3-3).

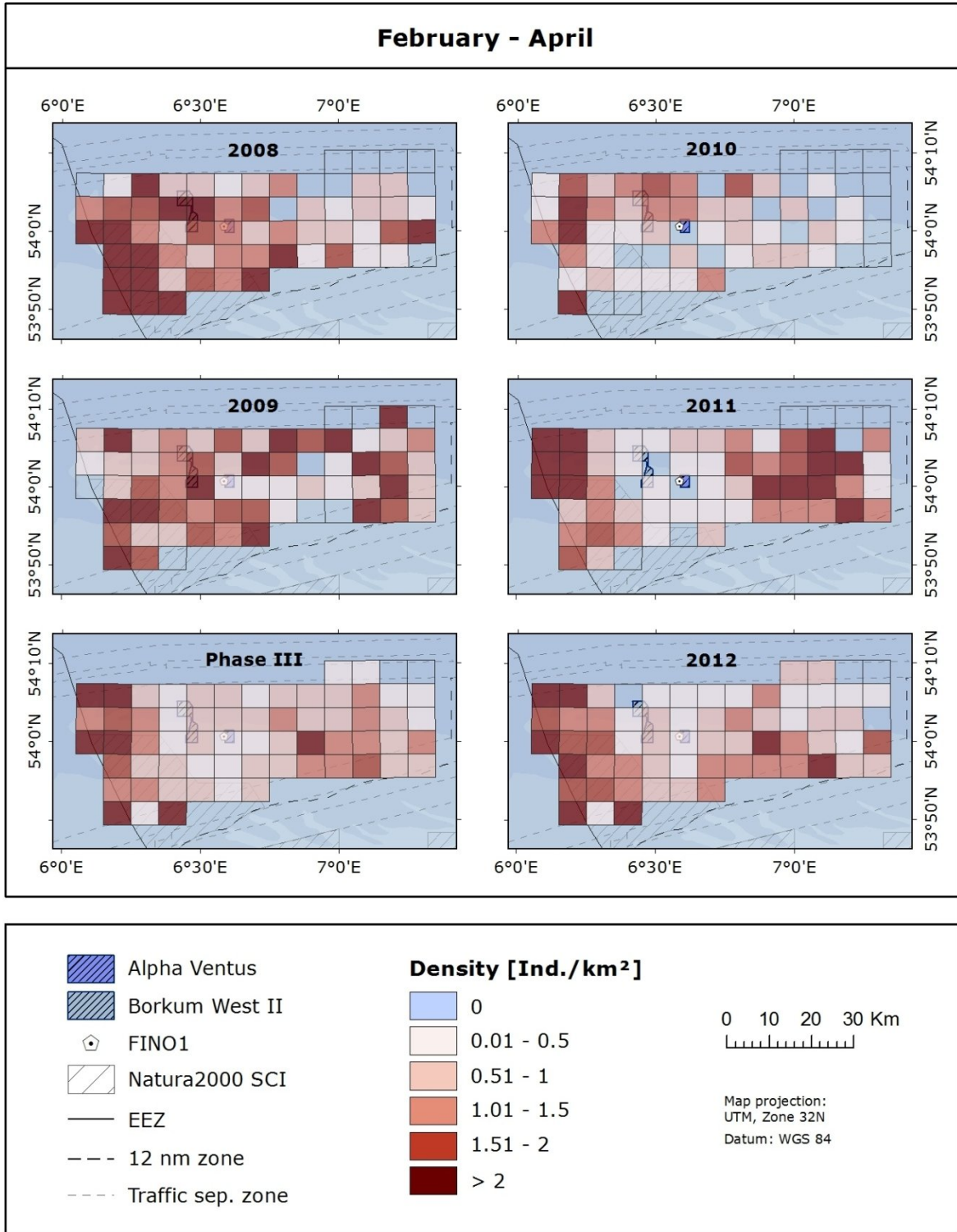

Fig. 3-1: Raster map of harbour porpoise densities in spring (Phase III = 2010-2012/13).

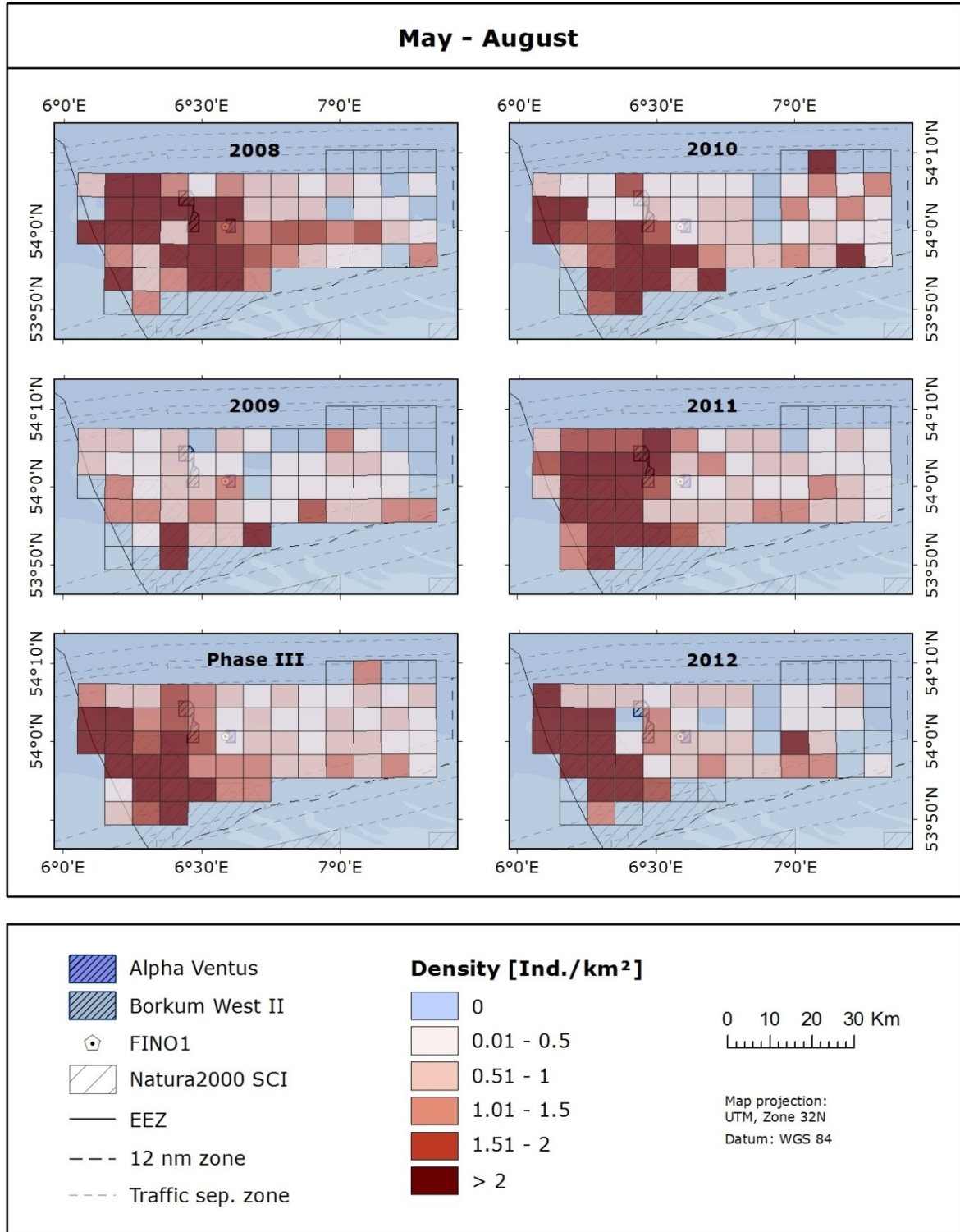

Fig. 3-2: Raster map of harbour porpoise densities in summer (Phase III = 2010-2012).

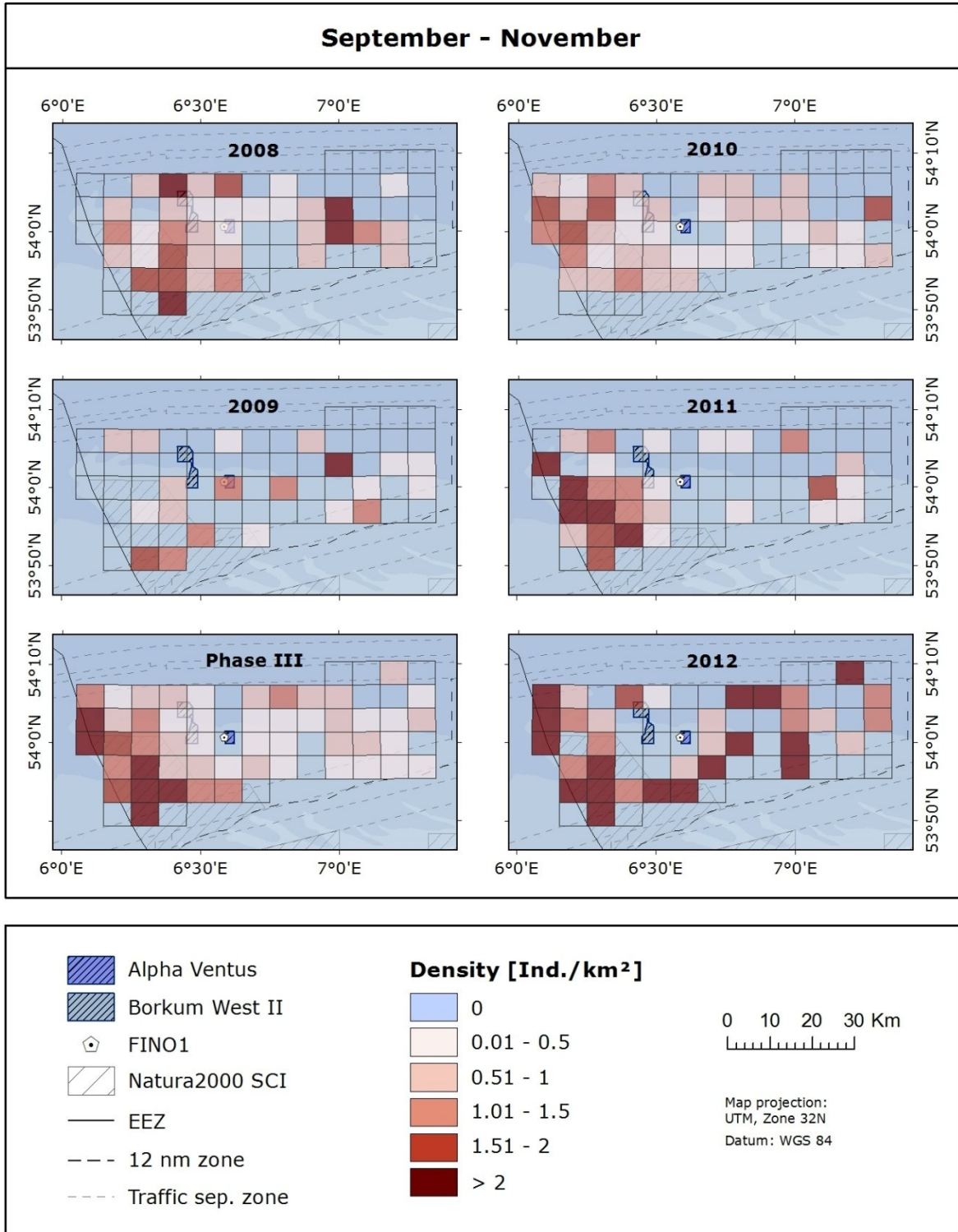

Fig. 3-3: Raster map of harbour porpoise densities in autumn (Phase III = 2010-2012).

Seasonal density maps indicated remarkable differences between the western and eastern part of the project area. In order to evaluate phase differences and phenological trends in harbour porpoise densities in more detail, calculations were done separately for two spatial subareas ('Aerial West' and 'Aerial East'; see Fig. 2-14).

Overall harbour porpoise phenologies were quite similar in both subareas (Fig. 3-4), showing peaks from April to June and from November to December (the latter based on fewer data) on average. Minima occurred in January/February and October. However, densities in the area 'Aerial West' were approximately twice as high as in subarea 'Aerial East'.

Phenologies differed slightly between the years of investigation (Fig. 3-5). However, at this temporal fine-scale the generally high variability of aerial survey data had to be taken into account. In contrast to PAM data, the aerial survey data did not represent a continuous time line, but had to be regarded as occasional snapshots, biased by weather conditions and other issues. When only looking at a seasonally comparable period also spanning pile-driving activities in 2009 (15.5.-31.7.), densities were lowest in 2009, the year of the windfarm construction (Fig. 3-5). However, since only few surveys were available for this period (2008: $n = 4$; 2009: $n = 6$; 2010: $n = 8$; 2011: $n = 6$; 2012: $n = 4$), no statistical inference could be drawn. By contrast, in spring and autumn density maps showed highest values in 2012/13, in this respect being similar to highest PAM daily detection rates $PP10M/day$ in 2012 at most POD station clusters.

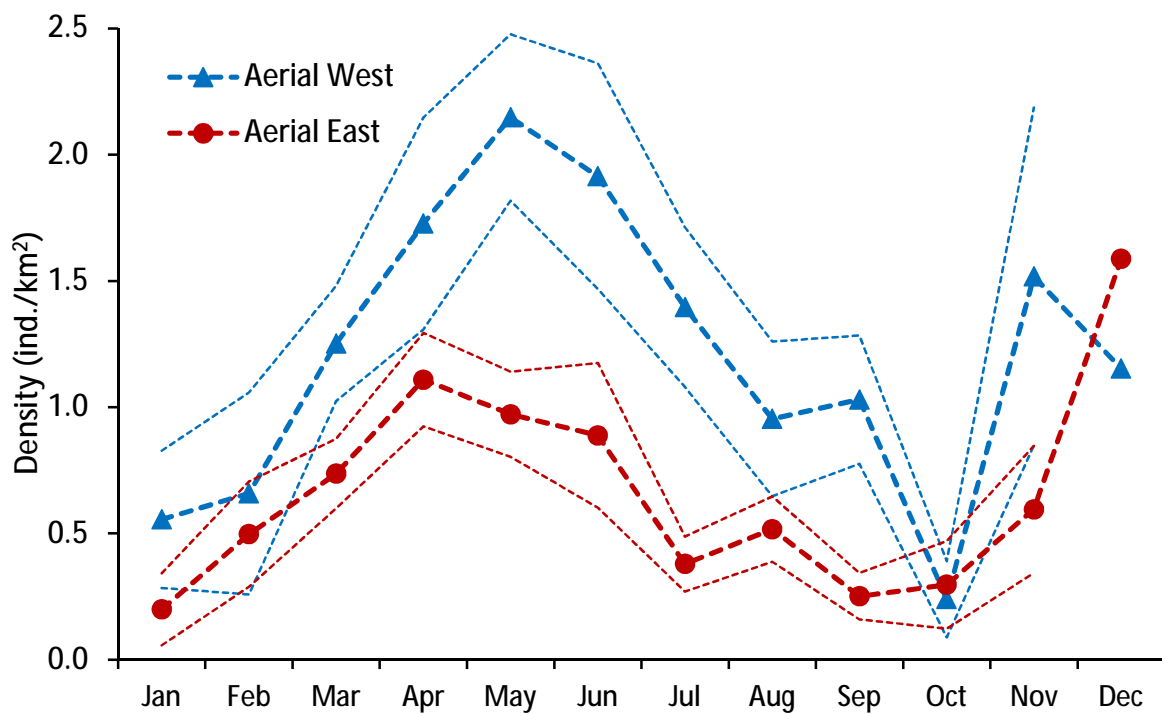

Fig. 3-4: Average monthly harbour porpoise densities across all project phases for both subareas (with 95% confidence intervals for months with more than three flight surveys; data of both types of aerial surveys).

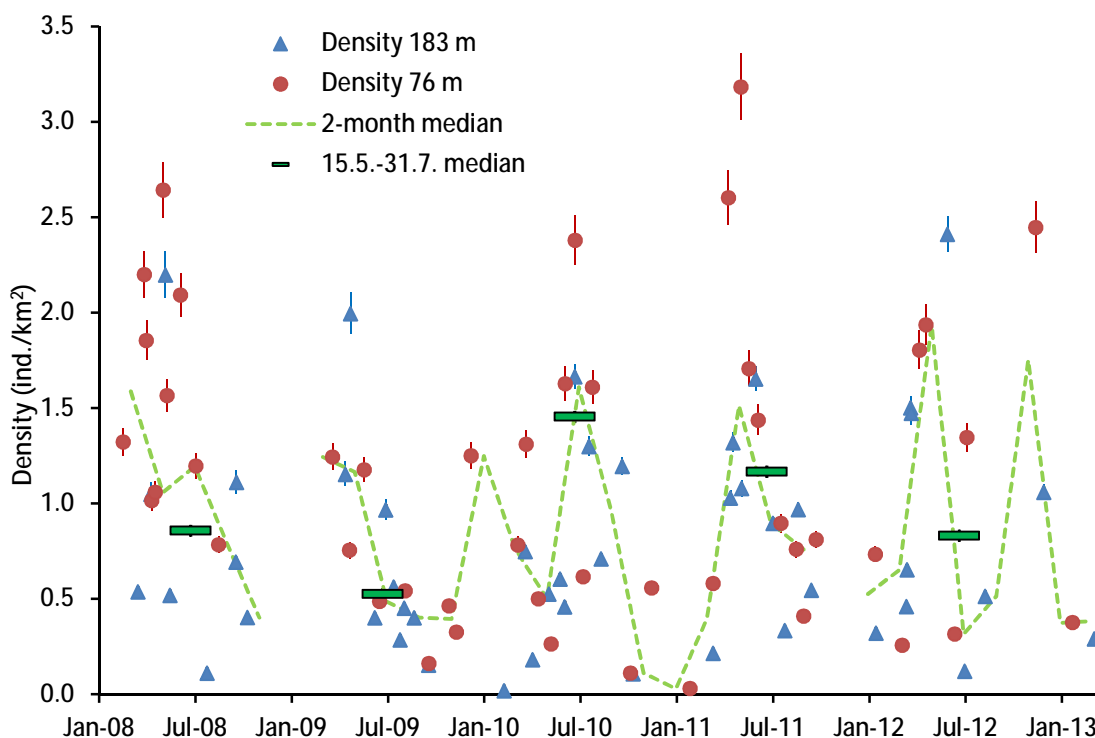

Fig. 3-5: Harbour porpoise densities (ind./km²) per aerial survey across the study years; green dotted line indicates the 2-month average (median); green bars represent the median of all density values above and below this bar, regarding a seasonally comparable period spanning pile-driving activities in 2009 (bar width equals time span: 15.5.-31.7.).

Proportion of calves

The rates of observed calves remained stable across all project phases, and ranged around 10% on average over all aerial surveys of a certain project year (Tab. 3-1). A negative effect of the construction works in 2009 on the proportion of calves was not detectable.

Tab. 3-1: Numbers of observed calves during main calving season (15th May to 31st August) of each year of investigation.

Harbour porpoises between 15 th May and 31 st July	Sum all Ind.	Sum Calves	Calves (%)
2008 (Phase I)	124	11	8.9%
2009 (Phase II)	203	17	8.4%
2010 (Phase III-1)	467	60	12.8%
2011 (Phase III-2)	410	39	9.5%
2012 (Phase III-3)	240	20	8.3%
Total:	1444	147	10.2%

Behaviour

Regarding Phase I, a total of 632 behavioural observations were analysed (including observations invalid for density calculations and those made by the control observer), 82% of which falling into categories of directional swimming at moderate to high speed, about 10% being categorised as drifting, and 6% being classified as vertical diving. Other behaviour was rarely observed (Tab. 3-2).

Tab. 3-2: Proportion of behavioural categories of harbour porpoises observed during project alpha ventus by aerial surveys of both types.

Behavioural category	Phase I (n = 632)	Phase II (n = 962)	Phase III-1 (n = 739)	Phase III-2 (n = 958)	Phase III-3 (n = 901)
Directional swimming at moderate speed	73.4	71.7	60.5	69.0	74.7
Drifting (no movement)	9.7	16.9	16.8	12.6	15.0
Directional swimming at high speed	8.4	3.7	8.1	5.2	3.9
Vertical diving	6.3	2.9	5.0	3.7	0.8
Other	2.2	4.7	9.6	9.5	5.7

During Phase II, a total of 962 behavioural observations were analysed, 75% of which being classified as directional swimming at moderate to high speed, about 17% as drifting (highest value of all phases), and 3% as vertical diving. Other behaviours amounted to around 5% (Tab. 3-2).

Within the first year of Phase III (2010), the percentage of directional movement was lowest, compared to all other phases, amounting to 69%. Instead, drifting and other behaviours were observed slightly more frequently. The proportion of directional swimming increased during the second (2011: 74%) and third year (2012/13: 79%) of Phase III.

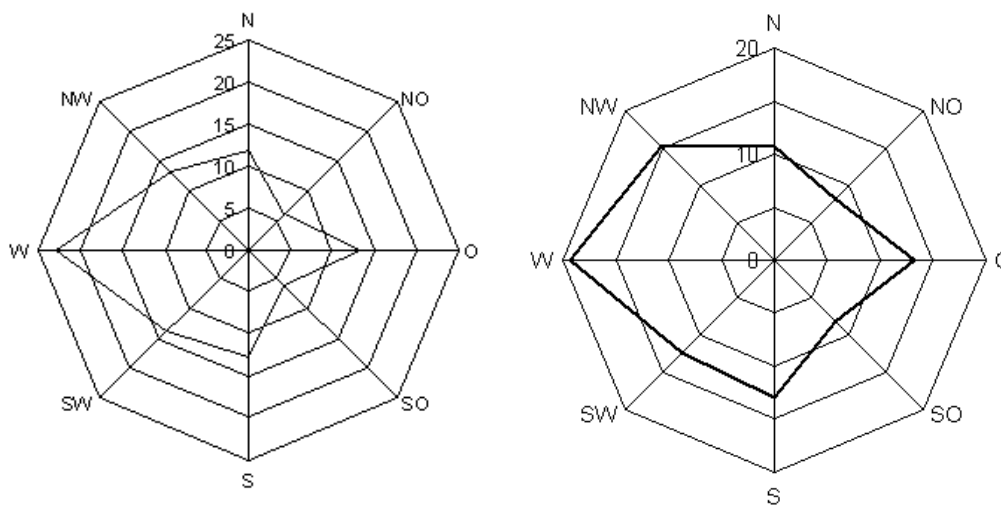

Fig. 3-6: Directionality of harbour porpoise movements (%) assessed during Phase I (2008; left panel; n = 564) and Phase II (2008/09; right panel; n = 658) by both types of aerial surveys within the alpha ventus area (angle of class width: 45°).

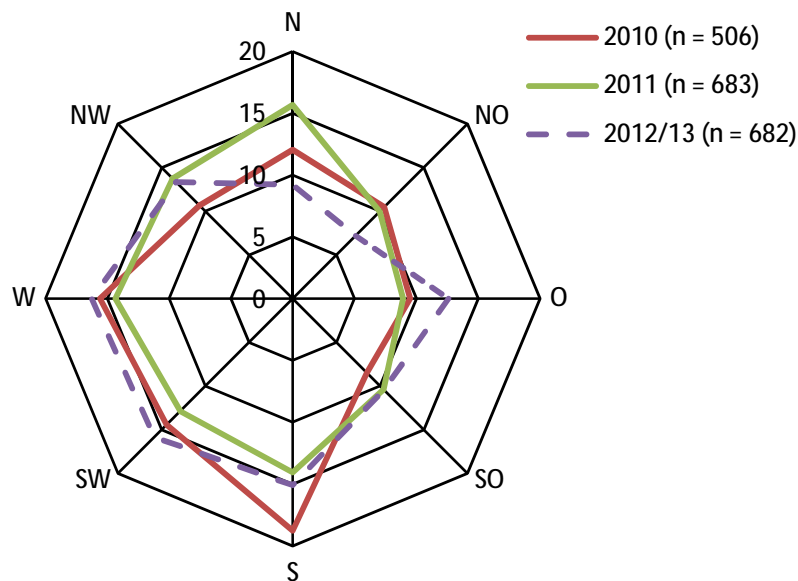

Fig. 3-7: Directionality of harbour porpoise movements (%) assessed during Phase III by both types of aerial surveys within the alpha ventus area (angle of class width: 45°).

For all phases, the proportion of moderate and fast directional swimming differed between months. However, due to methodological constraints seasonality was difficult to assess in an exact way. Furthermore, proportions of behavioural categories differed not clearly enough to allow statistically sound inferences from the observed trends.

Movement of harbour porpoises observed during Phase I mainly took place in a westward direction (southwest to northwest: 50%), the rate being twice as much as for eastward directions (southeast to northeast; Fig. 3-6). The rate for northward and southward swimming was balanced (12% each). No seasonal pattern occurred.

During Phase II, the pattern of directionality of movements was similar to Phase I. Westward swimming amounted to 49%, eastward movement only to 19% (Fig. 3-6). Again, northward and southward swimming was balanced. The pattern was remarkably stable during Phase II.

Directionality of swimming was more balanced during Phase III. In 2010, south- and westward movement predominated, whereas in 2011 all directions were similarly proportioned, except for slightly lowered eastward swimming. In 2012/13 northeasterly movement was reduced, compared to the other directions.

In summary, most harbour porpoises moved south-westwards during Phase III, whereas westward swimming predominated during Phase I and Phase II.

Effects of pile driving

First, the effects of pile-driving activities were evaluated by comparing densities (assessed by both types of aerial surveys) of phenologically similar periods with and without pile-driving. Between June and August seven flights (adding up to six complete transect surveys; see Tab. 3-3) at pile-driving days (end of pile-driving work at maximum 12 hours before the surveys started) were

compared to five surveys at days without pile-driving (end of pile driving at least 24 hours before the surveys started). Even though the mean density was lower at pile-driving days when compared to days without pile-driving (Fig. 3-9), this difference was not significant ($p = 0.54$).

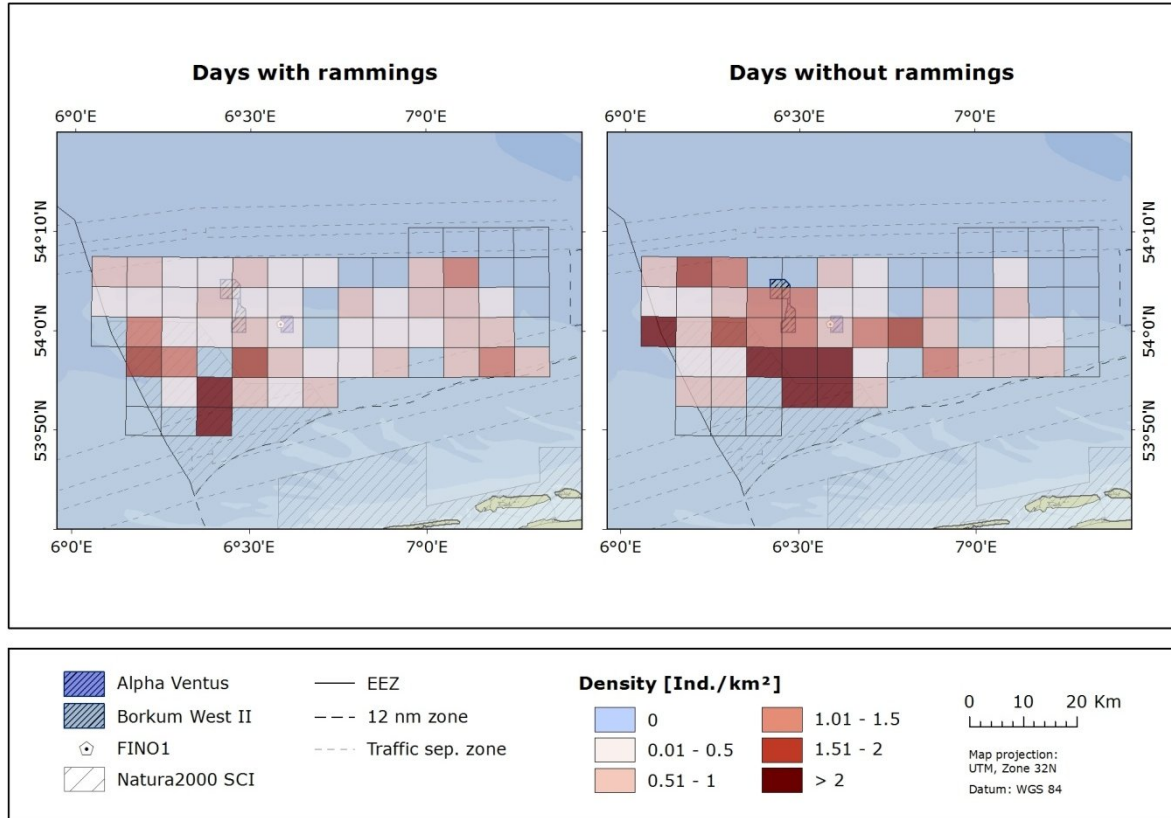

Fig. 3-8: Densities from June to August 2008 and 2009 at days with and without pile-driving.

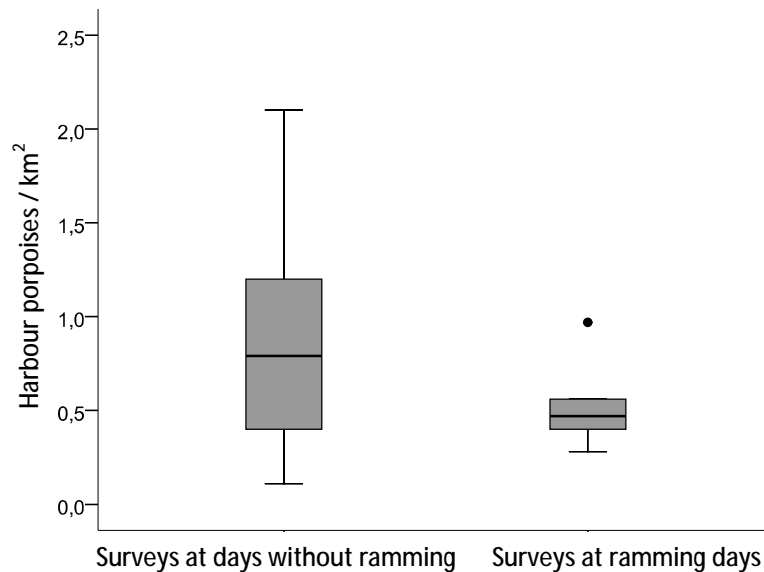

Fig. 3-9: Boxplot of harbour porpoise densities assessed during aerial surveys (both types) at days with and without pile-driving between June and August 2008 and 2009.

Then it was tested for the significance of differences of the short-term effects of pile-driving. Densities during five transects without pile-driving were compared to those of six transects at days with pile driving (Tab. 3-3), separately for a defined 'Impact Area' and two reference areas ('Reference West' and 'Reference East'; all subareas were part of the total aerial survey area; see Fig. 2-15). No significant density differences were found between days with and without pile-driving for each subarea ('Impact Area': $p = 0.25$; 'Reference West': $p = 0.43$; 'Reference East': $p = 0.91$; Fig. 3-10).

Tab. 3-3: Harbour porpoise densities in the flight survey 'Impact Area' and the two reference areas, assessed during aerial surveys (both types) between June and August 2008 and 2009; days without pile-driving were compared to those with pile driving (red).

Date	Impact Area	Reference West	Reference East
04.06.2008	6.77	1.31	0.22
03.07.2008	2.41	1.77	0.00
24.07.2008	0.12	0.28	
15.08.2008	0.42	1.10	0.51
08.06.2009	0.09	0.61	0.93
17.06./03.07.2009	0.00	0.35	0.78
29.06.2009	1.36	0.74	3.58
14.07.2009	0.24	0.48	0.60
26.07.2009	0.09	0.48	0.00
03.08.2009	0.25	0.62	0.31
22.08.2009	0.00	1.25	0.00

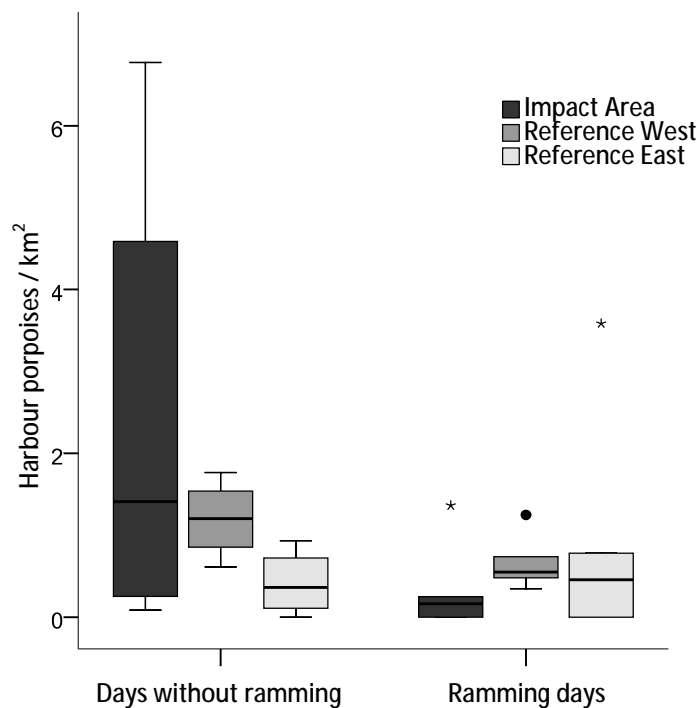

Fig. 3-10: Boxplot of harbour porpoise densities in the flight survey subareas 'Impact Area' (dark grey), 'Reference West' (grey), and 'Reference East' (light grey), as assessed between June and August 2008 and 2009 during aerial surveys at both altitudes (183 m, 76 m); data split into days with and without pile-driving.

Furthermore, at days with pile-driving (Fig. 3-10, right hand) no overall significant density differences occurred among the three subareas ($Chi^2 = 3.22$, $n = 6$, $p = 0.20$), even though lowest mean densities were found in the 'Impact Area'.

In summary, by means of aerial transect surveys (both types combined) in seasonally comparable periods no statistical difference of harbour porpoise densities was detectable between days with and without pile-driving, even though indication of a tendency towards lower densities at days with pile-driving was given. Non-significance of the results might partly be prone to the small dataset available for aerial surveys at days with pile-driving, and to the snapshot nature of aerial survey data being strongly affected by highly variable short-term conditions.

Seals and other marine mammals

Within Phase I (February to July 2008), 15 seals were observed during four of five marine mammal aerial transect surveys (eight harbour seals, six grey seals, one unidentified seal; Supplements: Tab. 8-7). 21 seals were sighted during eight of nine combined marine mammal/bird flights (18 harbour seals, four grey seals; Tab. 8-8). Sightings occurred in all parts of the project area, even where depths exceeded 30 m.

Regarding the construction phase (Phase II; end of July 2008 to December 2009), only five harbour seals and one grey seal were observed during five of twelve marine mammal flight surveys (Tab. 8-7), as well as seven harbour seals and an unidentified seal during five of ten combined marine mammal/bird survey flights (Tab. 8-8). A white-beaked dolphin (*Lagenorhynchus albirostris*) was recorded in the western part of the project area on 27th of October, 2009.

Standardised individual numbers per valid transect km were calculated for harbour seals, grey seals, and unidentified seals for all aerial survey data obtained during the project (Fig. 3-11). No clear pattern of seasonality was detected for harbour seals and grey seals.

Regarding a seasonally comparable period also spanning pile-driving activities in 2009 (15.5.-31.7.), harbour seals showed lowest occurrences during the construction phase (Fig. 3-11). From 2010 to 2012/13 the numbers of harbour seals were two to three times higher than during the Baseline survey in 2008, and about an order of magnitude higher than during Phase II (Tab. 8-7; Tab. 8-8).

Due to the lower number of sightings, the pattern was more variable for grey seals. Remarkably, numbers went down to just one sighting during the complete Phase II. Standardised individual numbers of grey seals were higher again in 2010, but fluctuated strongly over the following years.

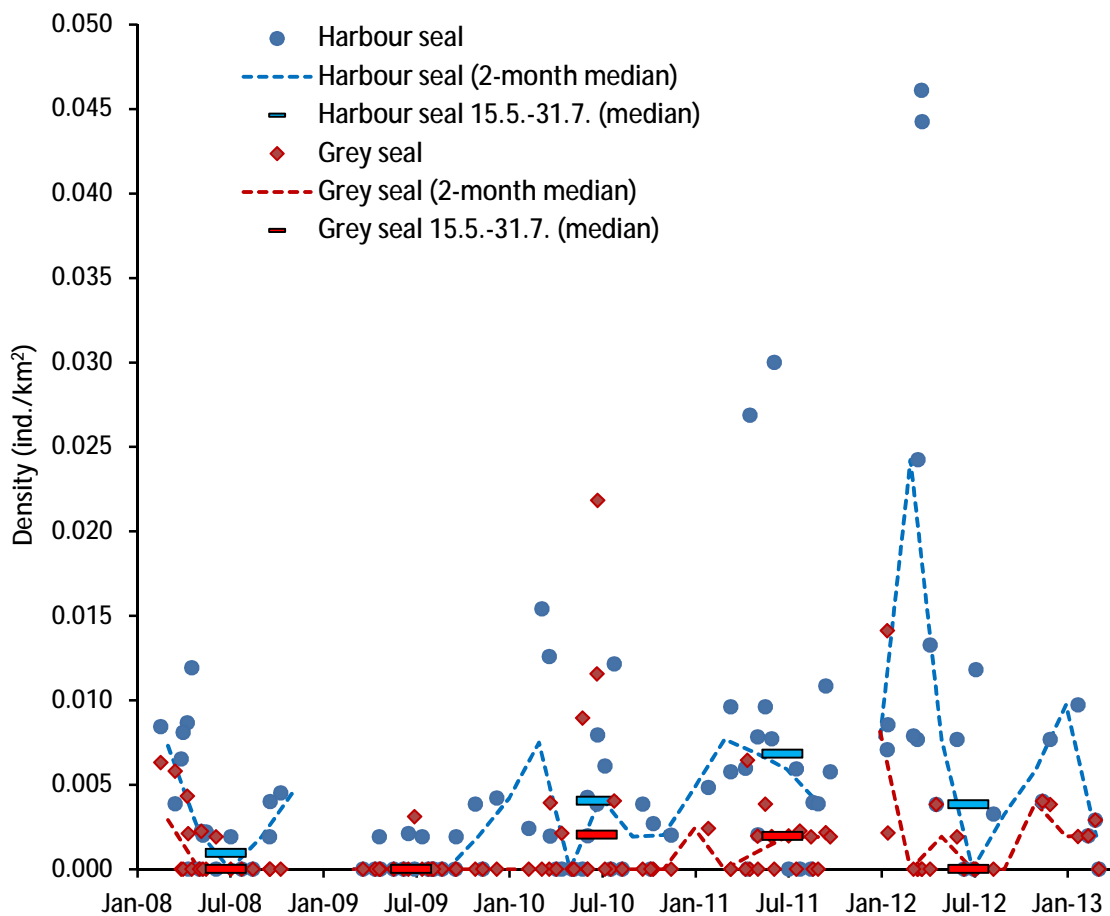

Fig. 3-11: Harbour seals and grey seals observed over the project years (ind./valid transect km); both types of aerial surveys combined; horizontal coloured bars represent the median of all density values of a certain species above and below this bar, regarding a seasonally comparable period spanning pile-driving activities in 2009 (bar width equals time span: 15.5.-31.7.).

Summarising, seals were only rarely sighted during the construction phase of the windfarm. Regarding a seasonally comparable period with pile-driving activities in 2009, standardised individual numbers of harbour seals and grey seals were lowest in 2009.

3.1.2 HiDef digital video surveys

Two HiDef digital video surveys were conducted during the project. Both took place in April 2013. On 1st April, 2013, 34 harbour porpoises were registered throughout the project area, and on 20th April, 2013, 57 harbour porpoises (Fig. 3-12). Four harbour seals were found at the latter date. In addition, ten unidentified mammals were registered during the first survey, and seven during the second survey. No pronounced spatial pattern became visible for harbour porpoises. In Fig. 3-13 harbour porpoise density calculated from sightings made during HiDef surveys are plotted together with calculated densities from conventional surveys between January 2012 and March 2013. Both surveys came up with densities very similar to conventional surveys conducted during previous months.

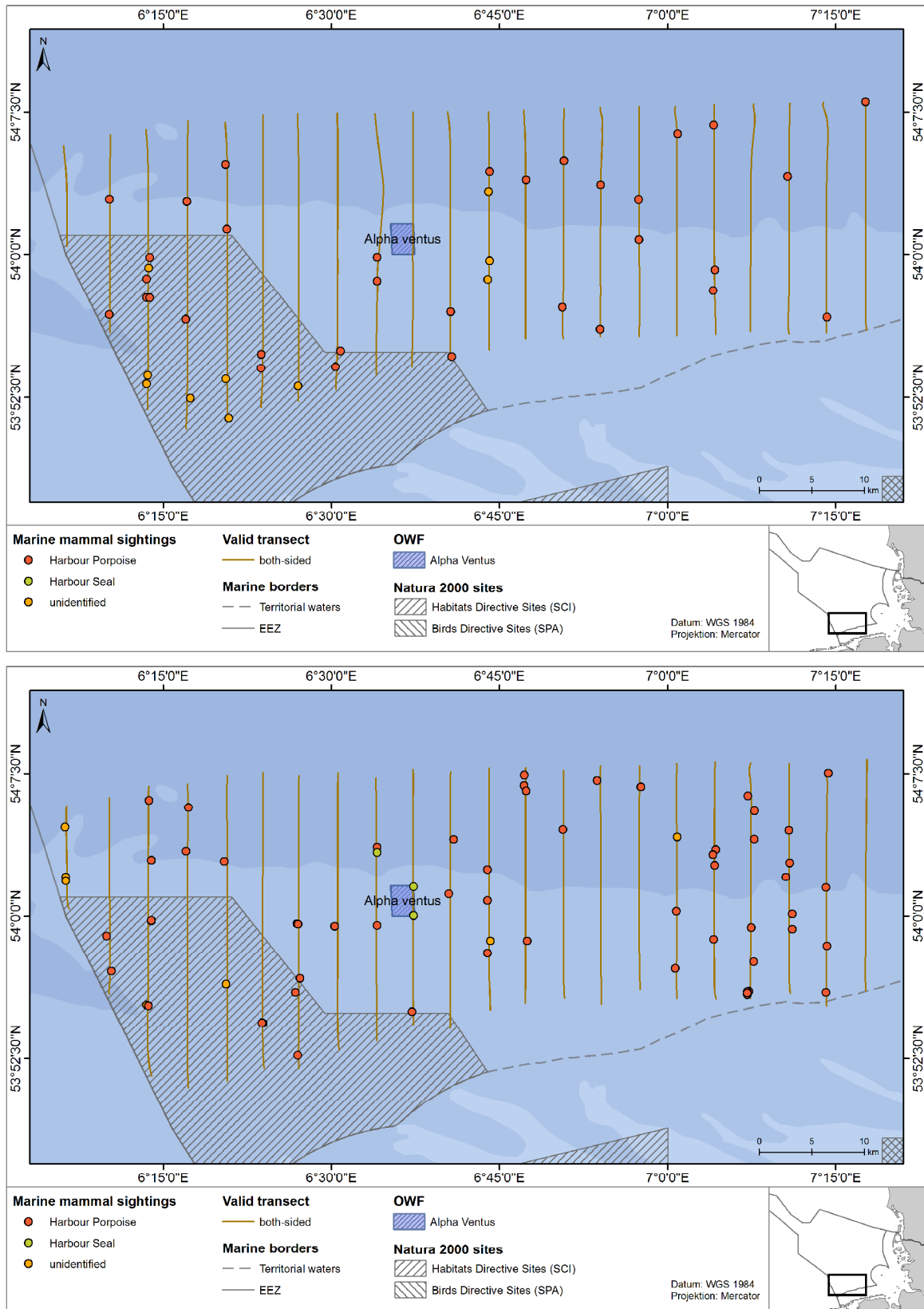

Fig. 3-12: Sightings of marine mammals from HiDef images of digital aerial surveys (upper panel: 1st April, 2013; lower panel: 20th April, 2013).

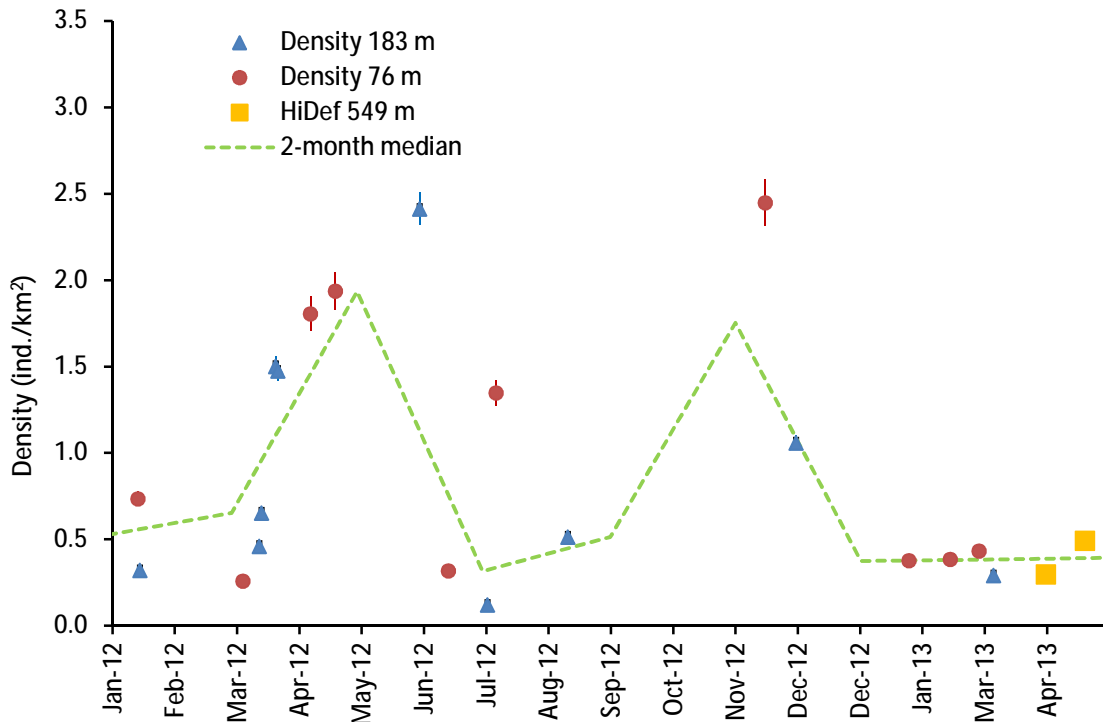

Fig. 3-13: Harbour porpoise densities (ind./km²) per aerial survey, beginning from January 2012 (clipping from Fig. 3-5), and including HiDef digital aerial surveys from April 2013.

3.2 Vessel-based surveys

3.2.1 Harbour porpoises

Even more than aerial surveys, vessel-based survey data were snap-shots prone to high variability of short-term conditions. In total, 994 harbour porpoise individuals out of 655 groups (sightings) were observed at 102 out of 132 vessel-based transect surveys for the project alpha ventus. 739 animals (74%) were sighted in subarea 'Vessel West', and 255 individuals (26%) in subarea 'Vessel East' (see Fig. 2-16 for positions of vessel-based survey subareas).

During the baseline survey (Phase I) of project alpha ventus, harbour porpoises were registered at seven of nine vessel-based transect surveys. 142 individuals out of 77 groups were sighted between February and July 2008 (Supplements: Tab. 8-11). The survey on 11th February 2008 alone provided 75% of all individuals of the baseline survey. 76% of the porpoises were observed inside 'Vessel West' and only 24% inside 'Vessel East'. The difference was mainly caused by the large number of animals registered inside 'Vessel West' on 11th of February, 2008. On average, 0.105 harbour porpoises were registered per valid transect km during Phase I ('Vessel West': 0.170 ind./km; 'Vessel East': 0.048 ind./km).

During the construction phase (Phase II) 19 vessel-based surveys were conducted, 13 with harbour porpoise sightings. These amounted to only 62 individuals out of 40 groups (Tab. 8-11). 66%

of the porpoise individuals were observed at ‘Vessel West’, and 34% at ‘Vessel East’. On average, 0.021 harbour porpoises were registered per valid transect km during Phase II (‘Vessel West’: 0.030 ind./km; ‘Vessel East’: 0.014 ind./km).

Most surveys took place during the operation phase (Phase III). Porpoises were sighted at 67 out of 77 ship surveys, summing up to 790 individuals out of 538 groups (Tab. 8-11). Overall, 75% of the animals were observed at ‘Vessel West’ and 25% at ‘Vessel East’. The proportion of porpoises sighted at ‘Vessel East’ increased from 15% in 2010 to around 30% in 2011 and 2012/13. The average group size in Phase III was 1.47 animals per sighting (‘Vessel West’: 1.54; ‘Vessel East’: 1.30). On average, 0.066 harbour porpoises were registered per valid transect km during Phase III (‘Vessel West’: 0.105 ind./km; ‘Vessel East’: 0.032 ind./km).

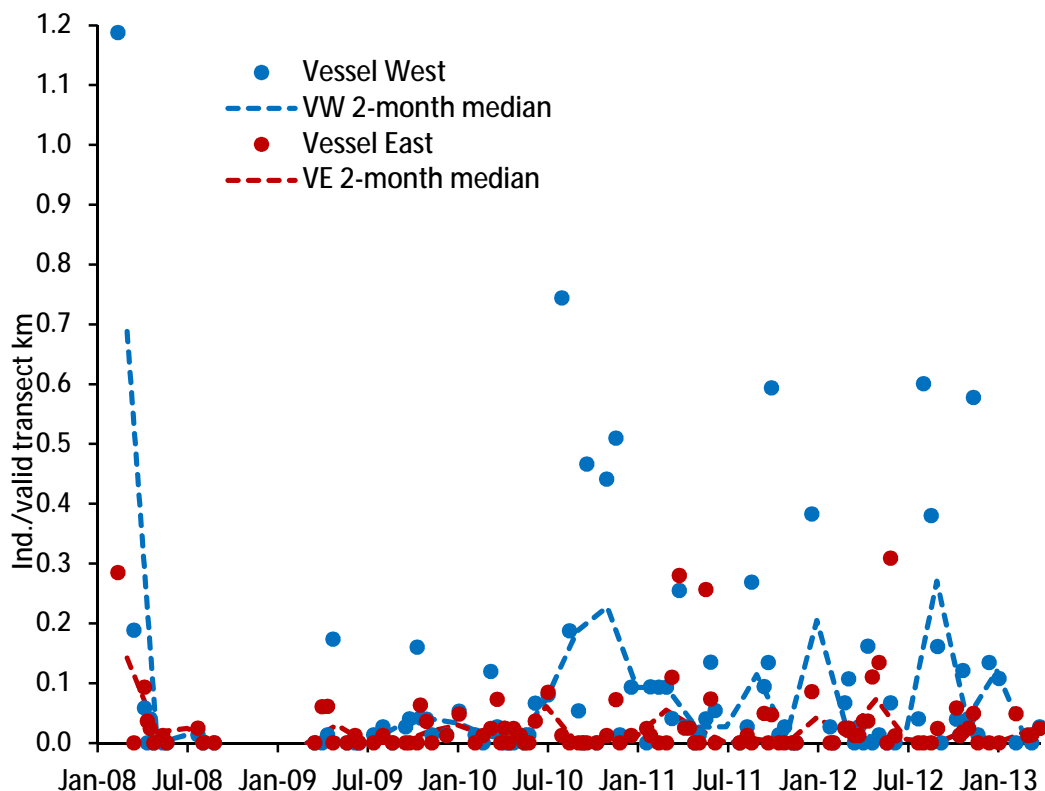

Fig. 3-14: Harbour porpoise individuals per valid transect km of vessel-based surveys in the subareas Vessel West (VW) and Vessel East (VE); dotted lines indicate the 2-month average (median).

Combined phenologies for all data (standardised sighting rates: ind./valid transect km) show that in subarea ‘Vessel West’ most sightings occurred in February and late summer/autumn (August to November), whereas only few porpoises were observed between April and July by vessel-based transect surveys (Fig. 3-14). By contrast, no clear seasonal pattern was found for ‘Vessel East’ where the rates were much lower than for ‘Vessel West’ for most months (except for April and May). The overall number of observed harbour porpoises per valid transect km was clearly higher in ‘Vessel West’, compared to subarea ‘Vessel East’ (Fig. 3-15), stressing the ecological importance of the NATURA 2000 SCI Borkum Reef Ground.

Over the whole area covered by vessel-based transect surveys, standardised harbour porpoise sighting rates were higher during the Baseline survey and the Operation phase, and lower during the Construction phase (Fig. 3-16).

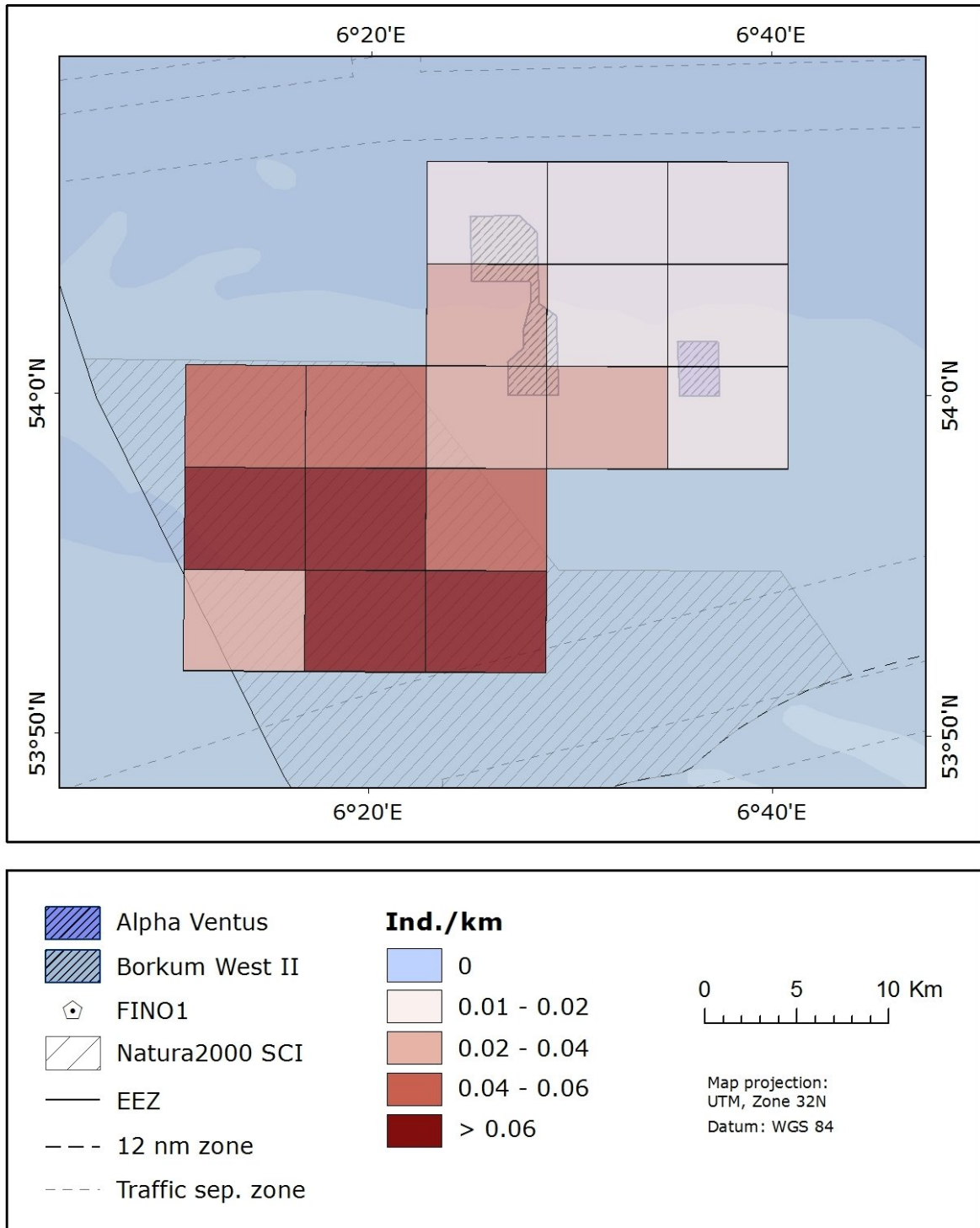

Fig. 3-15: Harbour porpoise individuals per valid transect km in subareas 'Vessel East' (nine rectangles in NE) and 'Vessel West' (eight rectangles in SW); all vessel-based surveys (2008 to 2013).

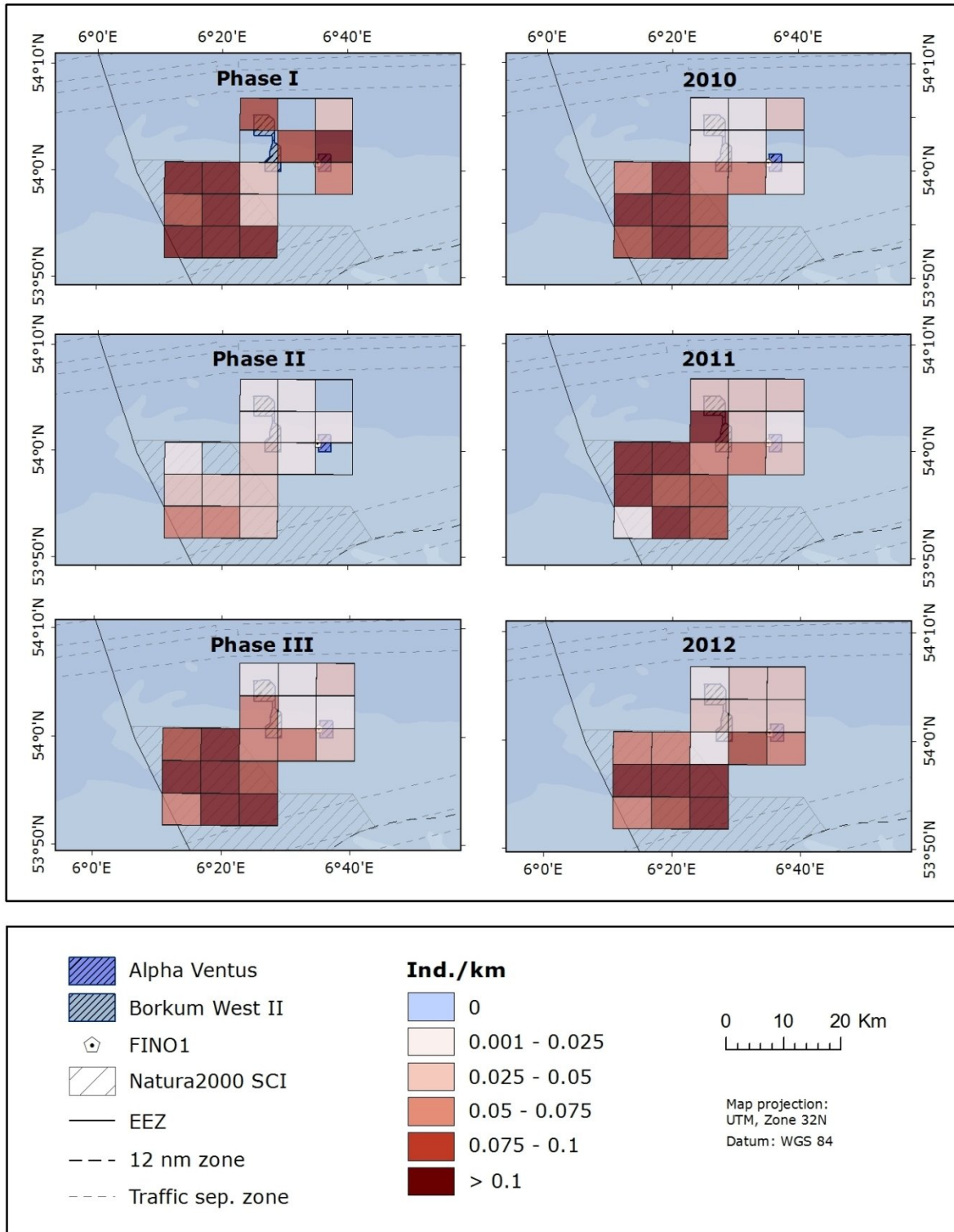

Fig. 3-16: Harbour porpoise individuals per valid transect km in subareas 'Vessel East' (nine rectangles in NE) and 'Vessel West' (eight rectangles in SW); data split after project phases (left panels); Phase III further split after years (right panels).

3.2.2 Seals and other marine mammals

In total, 212 seals and other marine mammals (except for harbour porpoises) were observed during 59 out of 106 vessel-based transect surveys for the project alpha ventus (Supplements: Tab. 8-12). Harbour seals were the most commonly recorded seals. However, no clear seasonal pattern was assessable due to the sparseness and variability of data (Fig. 3-18).

During nine surveys within Phase I, 13 harbour seals were sighted (mostly on 11th of February, 2008), with just two animals being observed inside 'Vessel East'. No further species were recorded.

During seven out of 19 surveys that took place within Phase II, a total of 20 seals and other marine mammals were sighted. In addition to 14 harbour seals, three grey seals and two unidentified seals were observed. A not further specified dolphin was registered on 12th of April, 2009. Even though more animals were observed in the 'Vessel East' (11 of 20 individuals: 55%), none of these sightings occurred in the period of pile-driving activities (24th of April to 26th of August, 2009). Similarly, in the same period only one harbour seal observation was made inside 'Vessel West', indicating a more extended effect of pile driving.

Due to the long duration of Phase III, by far the most seals and other marine mammals were sighted during this period (179 individuals at 67 out of 77 surveys). Similar to the other phases, ten times more harbour seals than grey seals were registered in the Operation phase (Tab. 8-12). By far less animals were observed in subarea 'Vessel East', but the proportion was increasing over the years (total: 59 of 179 individuals: 33%; 2010: 12 of 46 ind.: 26%; 2011: 25 of 85 ind.: 29%; 2012/13: 22 of 48 ind.: 46%). However, the overall number of observed animals was too low and variability too high to draw further conclusions.

More seals were recorded in subarea 'Vessel West' than in 'Vessel East' during vessel-based surveys. Hence, results resembled harbour porpoise distributional patterns in this respect (Fig. 3-17). Due to relatively low numbers of sightings, the effects of regional distribution patterns and construction work could not be disentangled, and no statement as to the impact of construction work on seals, based on data of vessel-based surveys alone, was possible.

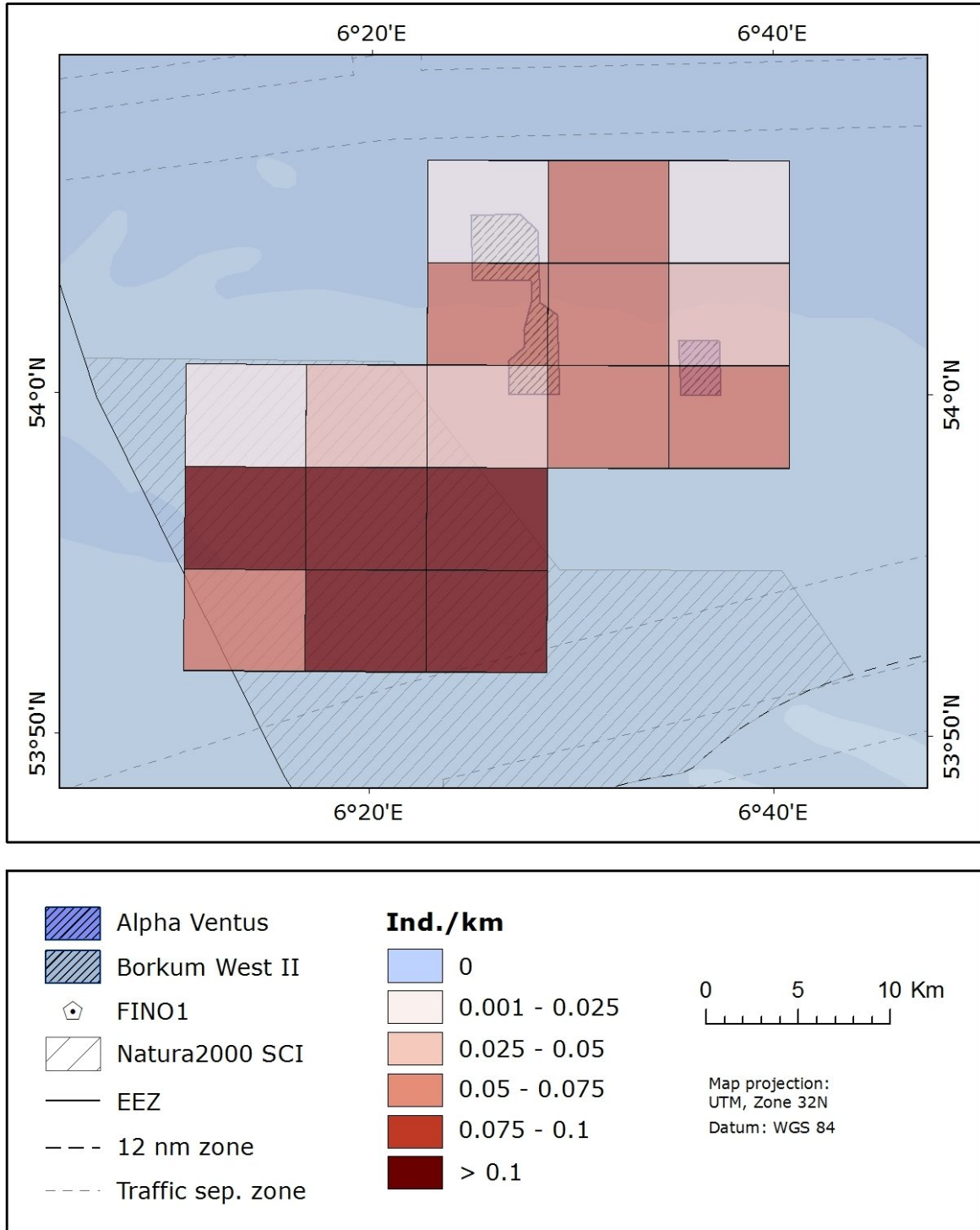

Fig. 3-17: Seals and other marine mammals (individuals per valid transect km) in subareas 'Vessel East' (nine rectangles in NE) and 'Vessel West' (eight rectangles in SW); all vessel-based surveys (2008 to 2013).

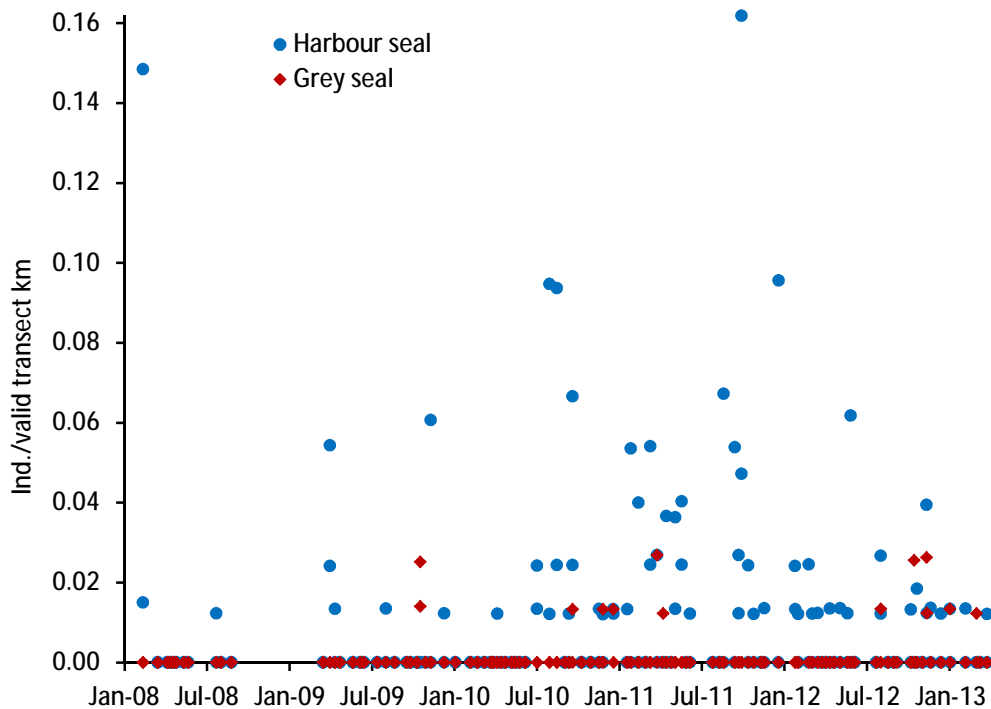

Fig. 3-18: Harbour seals and grey seals observed over the project years (ind./valid transect km) during vessel-based surveys; insufficient data for calculating medians.

3.3 Passive acoustic monitoring

3.3.1 Results across phases

Overall detection rates

Harbour porpoises were detected at 16,765 out of 17,325 possible POD days (sum of days when detections were possible over all stations; green bars in Fig. 2-21); this corresponded to a rate of porpoise positive days of 96.8%. Average daily harbour porpoise detection rates during the entire period of project alpha ventus amounted to 17.1 % *PP10M/day*. Split after POD station clusters, lowest rates were found in the vicinity of OWF alpha ventus, with 12.9 % *PP10M/day* for the 'Impact Area' and 12.6 % *PP10M/day* for 'Reference close'. Higher rates were found at 'Reference distant' with 19.0 % *PP10M/day*. Highest detection rates of 30.7% *PP10M/day* were recorded at 'Borkum Reef Ground'.

Phenology

During five years of POD deployment certain consistent patterns in harbour porpoise phenologies emerged from the large dataset. In order to assess phenological patterns spatially, the twelve stations deployed at a time (positions, however, were due to slight change; see Section 2.4.4) were assigned to six station clusters (Section 2.4.4), four of which being available during most parts of the 5-years period of the project alpha ventus: 1) 'Impact Area', 2) 'Reference close', 3) 'Reference distant', and 4) 'Borkum Reef Ground' ('Reference Southwest' (T12) and 'Reference East' (T13) not taken into account here; see Section 2.4.4).

Phenological analyses were hampered by failure of some PODs to collect data at certain periods, especially at the POD area 'Borkum Reef Ground'. Furthermore, PODs were not deployed during winter 2008/2009.

Principally, detection patterns were expressed on different temporal scales. Long-term trends were overlapped by seasonal effects, short-term transition events, and pile-driving effects, leading to phenological curves challenging to disentangle.

Firstly, phenological differences between 30-days moving averages of single years were evaluated for each station (Fig. 3-19). Afterwards, a seasonally comparable period also spanning pile-driving activities in 2009 (15.5.-31.5.) was further investigated in order to compare the investigation years (Fig. 3-20). Finally, time-series analyses were conducted in order to extract seasonal patterns and long-term trends from short-term fluctuations by Loess regression (Fig. 3-21).

As for 30-days moving averages of single years, seasonality of harbour porpoise detections was quite consistent over the years within each project area. However, it differed between the station clusters (Fig. 3-19). At 'Borkum Reef Ground', numbers peaked in June and July as well as in December, with occasional minor peaks in early spring and low rates in autumn. The other three station clusters were characterised by peaks in early spring and autumn. Patterns were mostly, but not entirely congruent over the years. For example, in 2012 at most clusters a peak occurred in May/June that was not expressed during the other years of investigation.

Pile-driving activities for OWF Trianel Windpark Borkum, Phase I (BW2) took place between September 2011 and March 2012 at distances between about 5 km and 20 km from the twelve alpha ventus stations, with an average of about 10 km distance (see Fig. 2-1). According to harbour porpoise phenology curves in 2011 and 2012 (Fig. 3-19), no clear effect of these pile-driving became visible. For 'Borkum Reef Ground', detection rates from October to December were lower in 2011 and 2012, compared to 2009. However, since this was not the case for the other three station clusters in comparable distance to BW2, the outcome was not directly addressable to pile driving for BW2.

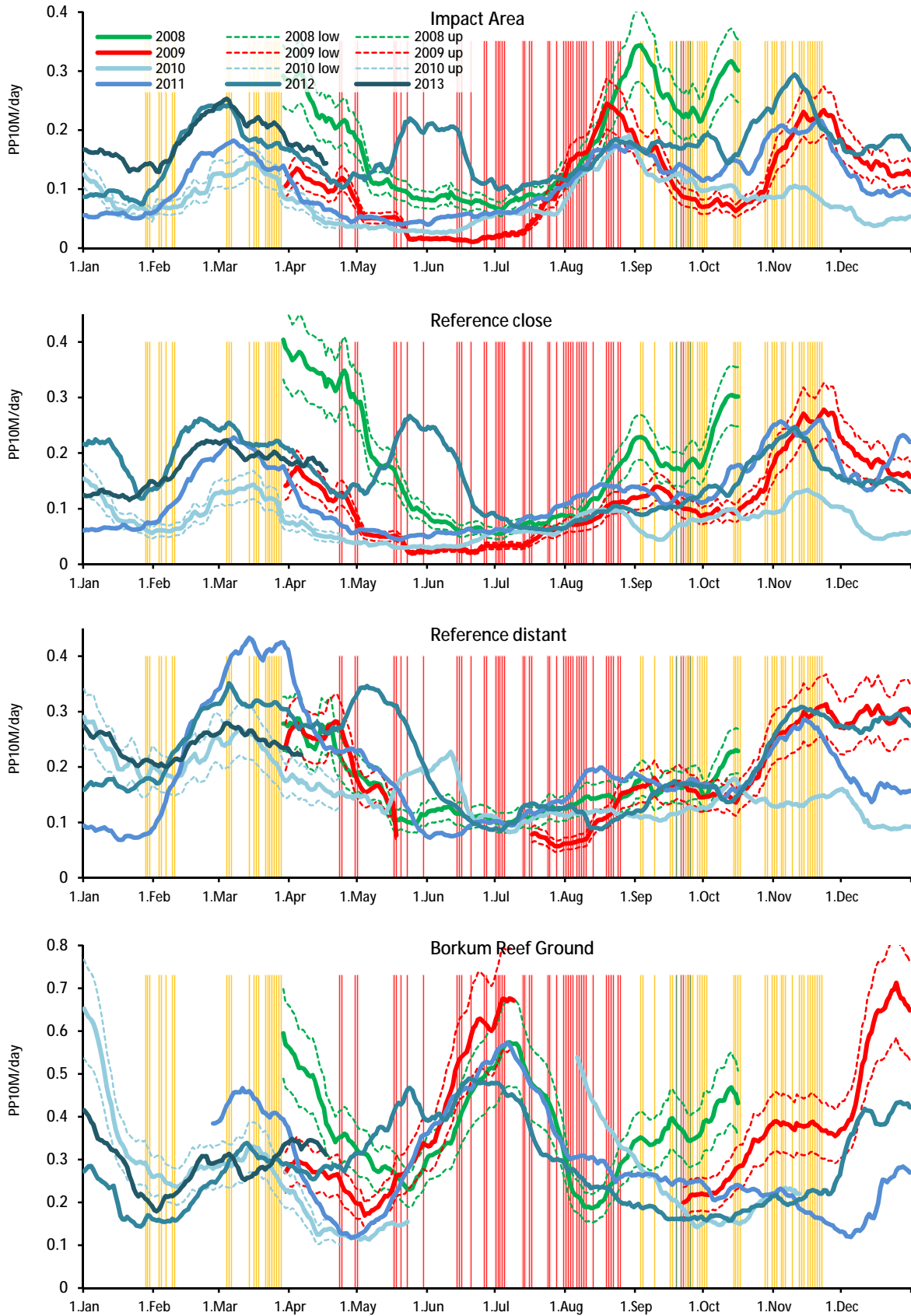

Fig. 3-19: Seasonal pattern of daily harbour porpoise detection rates (PP10M/day) across the years for the four POD station clusters; curves represent 30-days moving averages with confidence intervals of T-POD data for 2008 to 2010; vertical lines: pile-driving (green: alpha ventus 2008; red: alpha ventus 2009; yellow: Trianel Windpark Borkum, Phase I: Sept 2011 to March 2012).

During a seasonally comparable period also spanning pile-driving activities in 2009 (15.5.-31.7.), lowest average daily detection rates were found in 2009 and 2010 for the 'Impact Area' and 'Reference close' where also an increase of rates from 2010 to 2012 was found (Tab. 3-4; Fig. 3-20). Except for 'Borkum Reef Ground', where daily detection rates were highest in 2009, numbers were always highest in 2012, exceeding those of 2008.

For all POD station clusters, H-tests detected highly significant overall differences between the project years (Tab. 3-4). However, *H* values indicated that overall differences were less expressed for 'Borkum Reef Ground' and 'Reference distant' than for the 'Impact Area' and 'Reference close'. At the latter two clusters, daily detection rates were much lower in the years 2009-2011 than in 2008 and 2012. Except for 'Borkum Reef Ground', rates started to increase from 2009 onwards. In contrast to the results of the 'Impact Area' and 'Reference close', detection rates at 'Reference distant' were not significantly lower in 2009, 2010, and 2011, when compared to 2008 (indicated by confidence intervals in Fig. 3-20).

Tab. 3-4: Average PP10M/day values per project year and POD station cluster during a seasonally comparable period spanning pile-driving activities in 2009 (15.5.-31.7.); results of H-tests for overall differences between the project years.

	Impact Area	Reference close	Reference distant	Borkum Reef Ground
Phase I (2008)	0.098	0.104	0.118	0.386
Phase II (2009)	0.035	0.038	0.091	0.463
Phase IIIa (2010)	0.043	0.042	0.130	0.315
Phase IIIb (2011)	0.057	0.063	0.123	0.380
Phase IIIc (2012)	0.145	0.145	0.189	0.412
H-test (<i>H</i> value)	168.5	146.8	50.4	22.1
H-test (<i>p</i> value)	2.206E-35***	9.688E-31***	2.940E-10***	1.955E-4***

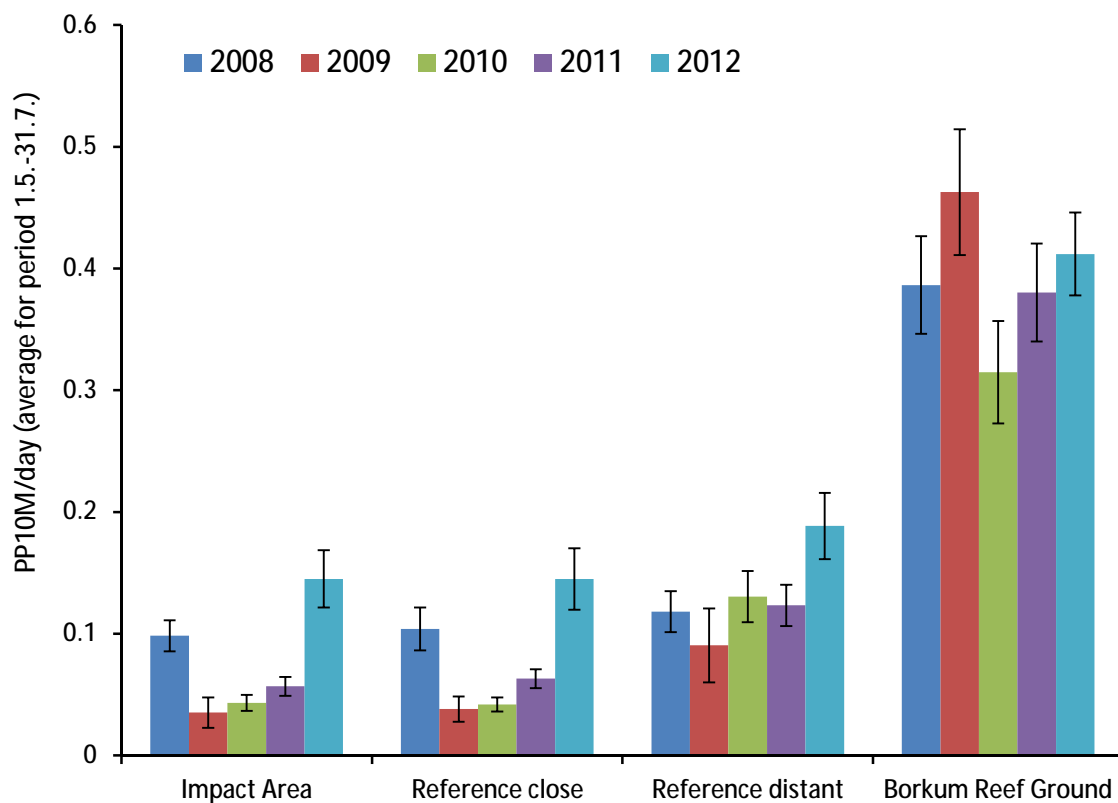

Fig. 3-20: Average PP10M/day values per POD station cluster and project year, during a seasonally comparable period spanning pile-driving activities in 2009 (15.5.-31.7.), with confidence intervals (data of Tab. 3-4).

The phenological pattern was investigated in more detail by means of time-series analyses which allow unravelling the mixture of seasonal pattern, long-term trend and remaining variability. Since this kind of analysis was only available for continuous datasets, we had to restrict it to Phase III data. This was unproblematic for the clusters 'Impact Area', 'Reference close', and 'Reference distant' (continuous data available from 15/12/2009 to 21/04/2013). At 'Borkum Reef Ground' we had to fill occasional gaps with moving-average values. Therefore, the latter area was not analysable on a seasonal scale (hence not visualised in Fig. 3-21), but the overall trend was still assessable.

As for the 'Impact Area', 'Reference close', and 'Reference distant', the detrended seasonal pattern peaked around November/December and March, with an additional minor peak in early autumn at the 'Impact Area' (Fig. 3-21; second panel in each graph). In summer rates were generally low for these three station clusters. The different seasonal pattern at 'Borkum Reef Ground' was already described above (p. 60; see also Fig. 3-19).

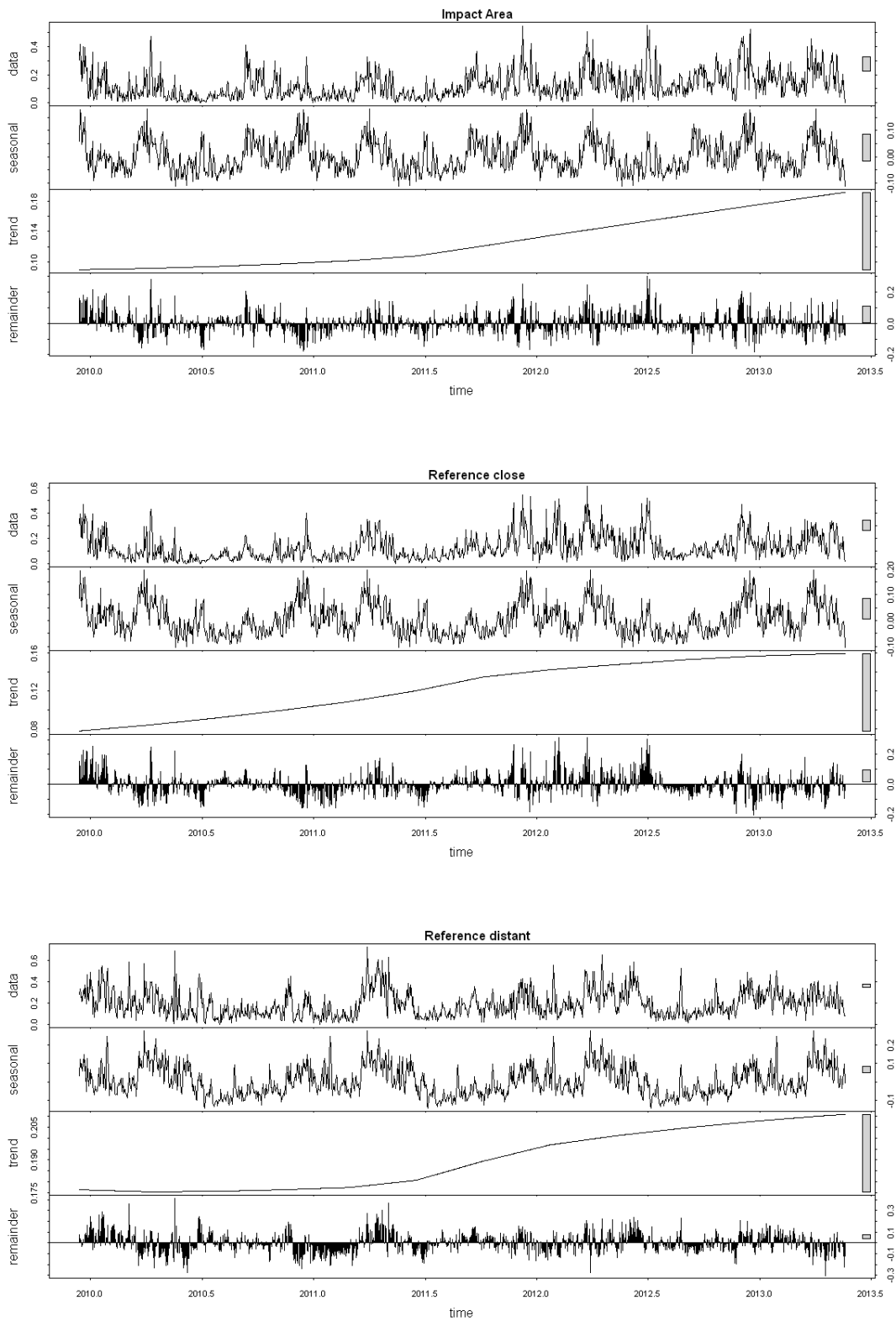

Fig. 3-21: Long-term trends (panel: 'trend'; mind different scales!) and seasonal patterns (panel: 'seasonal') at station clusters with continuously available data during Phase III (December 2009 to April 2013; time label: decimal years (2010.0 = 1st Jan, 2010; 2010.5 = 1st July, 2010); local polynomial regression fitting (Loess); further shown: raw data (panel: 'data') and remaining fluctuation (panel: 'remainder'); range bars on the right side represent equal range within each plot; 'Borkum Reef Ground' not shown here due to sampling gaps.

Long-term trends of increasing *PP10M/day* rates were expressed during Phase III at the 'Impact Area', 'Reference close', and 'Reference distant' (Fig. 3-21; third panel in each graph). The increase became smaller with increasing distance of the clusters from the windfarm (indicated by 'Trend' in Tab. 3-5, and trend lines in Fig. 3-21; regarding the latter figure, attention has to be paid to different scaling of the vertical axes). At 'Borkum Reef Ground' an even slightly negative long-term trend was found. At the 'Impact area' and 'Reference close', daily detection rates were more than doubled during the Operation phase of OWF alpha ventus, whereas at 'Reference distant' the rates increased by only 20%; at 'Borkum Reef Ground' an opposite trend of a 15% decrease was found. Hence, the substantial long-term increase of detection rates in the 'Impact area' and 'Reference close' during Phase III should have had a local component.

Tab. 3-5: Phase III initial (15/12/2009) and final (21/04/2013) values of long-term trends in *PP10M/day* detection rates (trend lines were also shown in Fig. 3-21 for the first three station clusters; Trend: percentage of increase/decrease during the entire Phase III).

Station cluster	Initial <i>PP10M/day</i>	Final <i>PP10M/day</i>	Difference	Trend
Impact Area	0.0896	0.1915	+0.1019	+114%
Reference close	0.0781	0.1595	+0.0814	+104%
Reference distant	0.1756	0.2107	+0.0351	+20%
Borkum Reef Ground	0.3375	0.2865	-0.0510	-15%

Long-term BACIP analysis

BACIP analyses were carried out on *PP10M/day* rates, when data of the Construction phase and Operation phase (= After) were compared to those of the Baseline survey (= Before) by Wilcoxon-Mann-Whitney rank sum tests for paired data (planned contrasts), based on 'Borkum Reef Ground' (= Control) and 'Impact Area' (= Impact) data. Daily rates of 43 congruent calendary days in spring/summer (between 2nd of May and 10th of September) were used for pairwise comparisons of detections of the years 2008 (Phase I) vs 2009 (Phase II) and vs 2010 (Phase III, 1st year) (see Section 2.4.7, p. 35, for BACIP methodology). Data of 66 congruent days in the same seasonal period were available for comparisons of the years 2008 (Phase I) vs 2011 and vs 2012 (Phase III, 2nd and 3rd year). As for 2013, no data were available in the given period.

The differences between Control and Impact data were highly significant between 2008 and 2009 (Phase I vs Phase II; Tab. 3-6). Detection rates were measured by T-PODs in both years and thus directly comparable, producing only a single test result. Pairwise differences with negative signs by far outnumbered those with positive signs (PR +/- in Tab. 3-6), indicating a strong BACIP effect. Daily detection rates were indeed reduced by more than 10% on average in 2009, compared to 2008 (mean and median in (Tab. 3-7).

Nine tests had to be conducted for Phase I vs Phase III comparisons, since T-POD data had to be converted into C-POD equivalents, with confidence intervals according to N_{sample} (see Section 2.4.7, p. 35). Differences between Control and Impact data were significant for eight of nine tests (six tests highly significant, including the median *p* value; Tab. 3-6) between 2008 and 2010 (Phase I vs Phase III, 1st year). Twice as much pairwise comparisons produced differential sums with negative signs, compared to those with positive signs. The BACIP effect was as strong as du-

ring the Construction phase, with detection rates lowered by 14.6%/9.6% (mean/median) on average in 2010 (Tab. 3-7).

Significant differences were also found with five of nine tests of comparisons between 2008 and 2011 (Phase III, 2nd year). The median test result was still significant, however, four of nine tests were not (Tab. 3-6). Pairwise differences with negative signs still clearly outnumbered those with positive signs. An average BACIP effect around 5% (decrease in 2011) was detected (Tab. 3-7) making up half as much as found for the preceding two years 2009 and 2010.

Seven of nine tests resulted in no significant differences between 2008 and 2012 data (Phase I vs Phase III, 3rd year), indicating only minor differences between the detection rates in spring/summer of these years. One significant test result was based on lower, the other one, however, on higher rates in 2012, when compared to 2008. Pointing into the same direction, the ratio of pairwise comparisons with negative and positive sign was almost balanced (Tab. 3-6), and the BACIP effect amounted to -1.6% on average (Tab. 3-7).

Tab. 3-6: BACIP analyses on PP10M/day rates of 43 (2008 vs 2009, 2010) resp. 66 (2008 vs 2011, 2012) selected calendar days in spring/summer (between 2nd of May and 10th of Sept) of the years 2008 to 2012; porpoise detection rates of the Baseline survey Phase I (Before: B) were tested against Phase II and III (After: A) data (Wilcoxon-Mann-Whitney rank sum tests for paired data; planned contrasts; Control was 'Borkum Reef Ground, Impact was 'Impact Area'); furthermore given: number of tests (Tests), number of significant tests (sign.), number of negatively vs positively significant tests (-/+ sign.), percentage of significant tests (% sign.), ratio of pair differences with positive sign by such with negative sign (PR +/-; a ratio around 1 would indicate no BACIP effect), and Z and p values of median ranked test results (with nine tests: 5th of nine); see Section 2.4.7, p. 35, for BACIP methodology.

Phases (B/A)	Years	Tests	sign.	-/+ sign.	% sign.	PR +/-	Z (median)	p (median)
I vs II	2008 vs 2009	1	1 of 1	1/0	100%	0.39	-2.9584	0.0031**
I vs III/1 st	2008 vs 2010	9	8 of 9	8/0	89%	0.48	-3.0670	0.0022**
I vs III/2 nd	2008 vs 2011	9	5 of 9	5/0	56%	0.61	-2.1304	0.0331*
I vs III/3 rd	2008 vs 2012	9	2 of 9	1/1	22%	0.90	-0.9870	0.3237 ns

Tab. 3-7: BACIP effect of Phase I (Before) vs Phase II/Phase III (After) spring/summer %PP10M/day porpoise detection rates, based on pairwise comparisons of 'Borkum Reef Ground' (Control) and 'Impact Area' (Impact) data (see Tab. 3-6 and text for further details); mean values, as well as median with first (Q25) and third quantile (Q75) are given, based on all available pairwise comparisons, including those containing converted T-POD data with upper and lower 95% confidence intervals.

Phases (B vs A)	Years (B vs A)	BACIP effect in %PP10M/day			
		Mean	Q25	Median	Q75
I vs II	2008 vs 2009	-12.5	-31.7	-10.6	+3.2
I vs III/1 st	2008 vs 2010	-14.6	-35.1	-9.6	+4.9
I vs III/2 nd	2008 vs 2011	-5.6	-16.0	-4.4	+5.5
I vs III/3 rd	2008 vs 2012	+1.1	-15.7	-1.6	+12.2

Summarising, with passive acoustic monitoring (PAM) a complete recovery of daily harbour porpoise detection rates (only spring/summer data) was earliest found three years after the construction of the windfarm alpha ventus. In this respect, the BACIP results were consistent with those of the phenological and time-series analyses. In contrast to the latter, BACIP analyses relied on 43 to 66 calendar days, which were seasonally biased: only spring and summer data were available here, since the Baseline survey spanned these seasons exclusively. The phenologies in autumn and winter were different (see Fig. 8-9), but those seasons were included only into time-series analyses. The latter uncovered a similar long-term increasing trend of detection rates in the 'Impact Area' during Phase III.

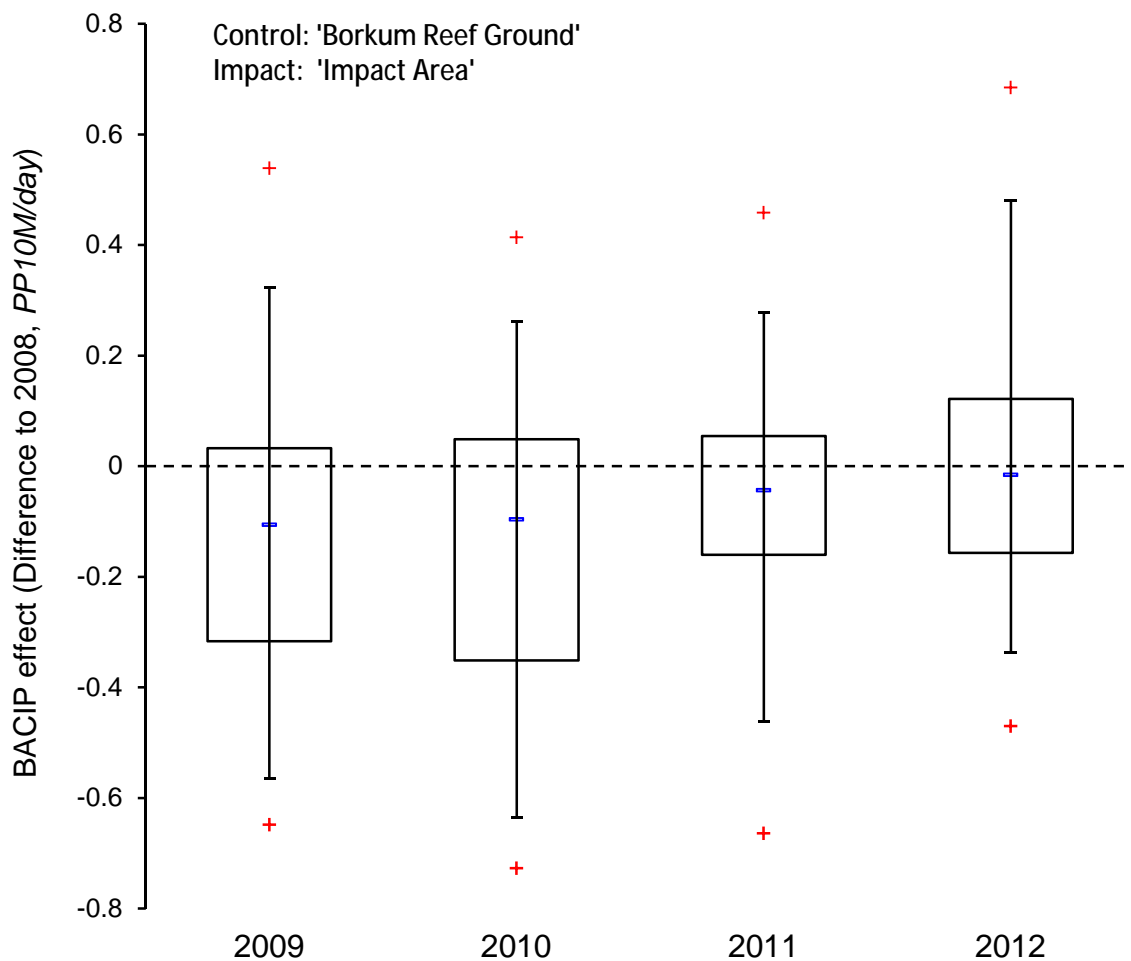

Fig. 3-22: BACIP effect regarding daily harbour porpoise detection rates PP10M/day, based on Phase I (2008) vs Phase II (2009) and vs Phase III (2010, 2011, 2012) data (visualisation of (Tab. 3-7); median (blue dash), Q25 and Q75 (box), Q10 and Q90 (vertical line), as well as extreme values (red plus) are shown in the plot.

Concluding, harbour porpoise detection rates (PP10M/day) in the close vicinity up to 2 km around the windfarm alpha ventus reached the level of the Baseline survey in 2012, a result that was concordant both with time-series and BACIP analyses of PAM data.

3.3.2 Phase I & II

Baseline survey

Data obtained during the Baseline survey mainly served as a reference regarding the effects of pile driving and windfarm operation on harbour porpoise activity patterns assessed by passive acoustic monitoring (PAM). The respective data were included with comparative analyses of the following sections. Phenological data of Phase I were analysed in Section 3.3.1.

Transformer substation pile driving

Construction works for the transformer substation took place between 18th and 25th of September, 2008. It was shown that daily harbour porpoise detection rates (*PP10M/day*) strongly decreased during that time, but were restored within the subsequent month (see Diederichs et al. 2009a). Whether this pattern was due to pile-driving, or a normal decline that also occurred in late September of other years (e.g., in 2009; see Fig. 3-19), remained unclear. The decrease during the period of pile driving was distance-dependent in a way that *PP10M/day* rates were lowered from 15% down to nearly 0% within 2 km distance from pile-driving. Between 2 km and 4 km distance from pile-driving detection rates decreased from 15% to about 5%, and in 14-18 km distance from 25% to 15% (Diederichs et al. 2009a).

PPM/hour rates uncovered negative effects of *Pile-driving events* more than two days after these, even in larger distances. However, only few data were available for larger time lags after *Pile-driving events*.

1st Waiting times were clearly extended after *Pile-driving events*. Though becoming less pronounced with increasing distance from pile-driving, the effect was still significant in 22 km distance (Diederichs et al. 2009a).

Turbine foundation pile driving

Overall effects of pile-driving activities: Daily resolution

GAM computation uncovered a significant effect of the explanatory variable *Pile-driving* on the dependent variable *PP10M/day* within distance class 1 (< 4 km distance to pile-driving locations) and class 2 (4-10.2 km distance), both when days before a pile-driving were considered (model 1), or not (model 2). For model 1 and distance class 3 (> 10.2 km distance) the effect of *Pile-driving* was significant at the lowest level (Tab. 3-8), rendering significance doubtful with GAMs (Wood 2006). Within distance classes 1 and 2 harbour porpoise activity (*PP10M/day*) started to decrease a few days before pile driving (model 1). The activity pattern showed a minimum at the day of pile-driving and increased to intermediate levels afterwards, however, without reaching the values from 5-6 days before pile driving (Fig. 3-23, Fig. 3-24). A similar pattern was just weakly expressed within distance class 3, where only *PP10M/day* values of the fifth and sixth day before pile-driving deviated significantly from the overall mean of model 1 (Fig. 3-25); regarding model 2, no effect of *Pile-driving* was detectable within distance class 3 (Fig. 3-25, lower panel; Tab. 3-8). Monthly activities increased from April to October for distance classes 1 and 3 (Fig. 3-23 and Fig. 3-25, right panels), whereas a converse pattern was found for distance class 2 (Fig. 3-24, right panels).

Tab. 3-8: GAM results (2009 data) regarding distance-dependent effects of the explanatory variables *Pile-driving* (day in relation to pile-driving), *Month*, *Position*, and *Year* on *PP10M/day* (model 1 and 2: see Section 2.4.7, p. 36); for the factors *Year* and *Position* degrees of freedom (df), for the smoothing factors *Pile-driving* and *Month* error degrees of freedom (edf) are given.

Response variable: <i>PP10M/day</i>						
Distance class	Model	Variable	df/edf	F	p value	% explained
1 (< 4 km)	1	<i>Pile-driving</i>	8.5	32.4	<0.001	46.1 %
		<i>Month</i>	3.9	27.1	<0.001	
		<i>Position</i>	6	12.4	<0.001	
		<i>Year</i>	1	27.1	<0.001	
	2	<i>Pile-driving</i>	2.8	48.0	<0.001	40.6 %
		<i>Month</i>	2.8	93.9	<0.001	
		<i>Position</i>	6	13.8	<0.001	
		<i>Year</i>	1	53.6	<0.001	
2 (4-10.2 km)	1	<i>Pile-driving</i>	4.6	9.0	<0.001	35.0 %
		<i>Month</i>	2.2	3.5	<0.05	
		<i>Position</i>	2	5.9	<0.05	
		<i>Year</i>				
	2	<i>Pile-driving</i>	2.3	8.9	<0.001	27.4 %
		<i>Month</i>	2.1	3.8	<0.05	
		<i>Position</i>	1	0.3	0.57	
		<i>Year</i>	1	3.4	0.07	
3 (> 10.2 km)	1	<i>Pile-driving</i>	3.4	2.5	<0.05	43.5 %
		<i>Month</i>	3.9	21.0	<0.001	
		<i>Position</i>	3	32.7	<0.001	
		<i>Year</i>	1	0.6	0.43	
	2	<i>Pile-driving</i>	1.8	1.7	0.11	46.1 %
		<i>Month</i>	2.0	22.5	<0.001	
		<i>Position</i>	3	39.1	<0.001	
		<i>Year</i>	1	16.0	<0.001	

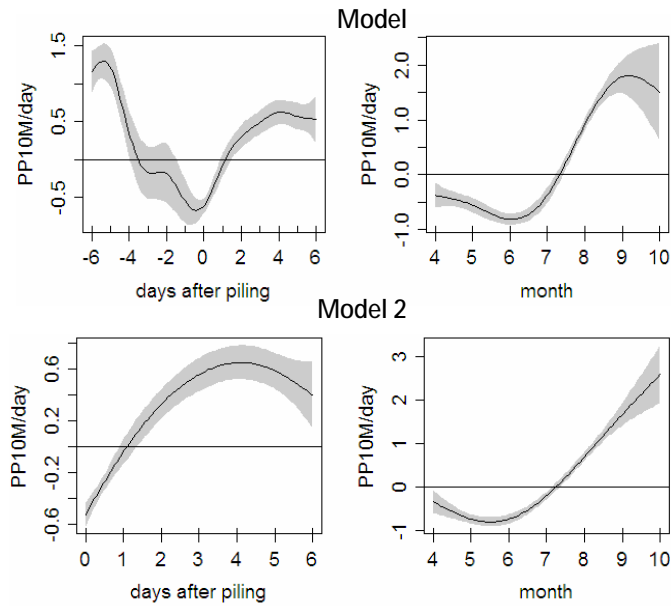

Fig. 3-23: GAM plots (2009 data) according to model 1 and 2 (see Section 2.4.7, p. 36) for distance class 1 (stations T1-T7), visualising the effects of Pile-driving (here: 'days after piling') and Month on daily harbour porpoise detection rates PP10M/day (horizontal line: overall mean of the model; curve and grey-shaded area: deviation of the model estimate from overall mean, with confidence intervals).

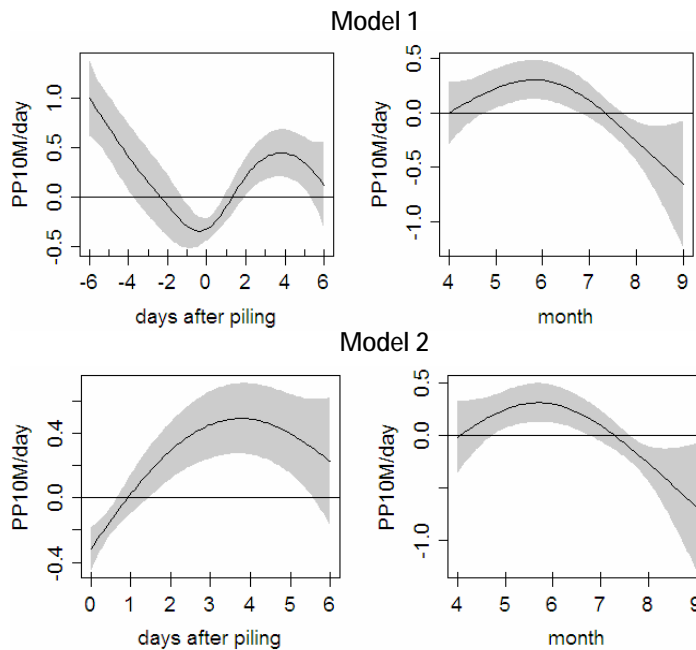

Fig. 3-24: GAM plots (2009 data) according to model 1 and 2 (see Section 2.4.7, p. 36) for distance class 2 (stations T8 and T12), visualising the effects of Pile-driving (here: 'days after piling') and Month on daily harbour porpoise detection rates PP10M/day (see Fig. 3-23 for further information).

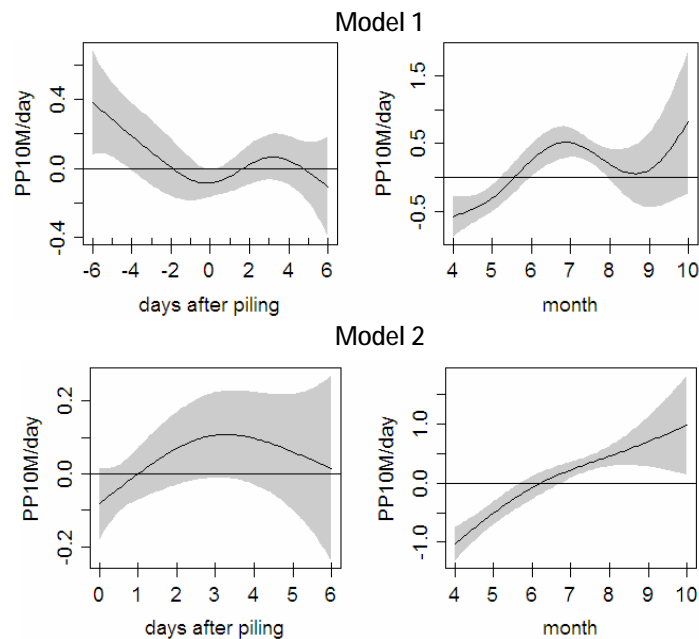

Fig. 3-25: GAM plots (2009 data) according to model 1 and 2 (see Section 2.4.7, p. 36) for distance class 3 (stations T9-T11), visualising the effects of Pile-driving ('days after piling') and Month on daily harbour porpoise detection rates PP10M/day (see Fig. 3-23 for further information).

GAM control models were computed with data from 2008 (Tab. 8-13), including hypothetical pile-driving at the same calendary dates as in 2009. These are presented in the supplements (Section 8.3.3, p. 154). Interestingly, within distance class 1 significant effects of hypothetical pile-driving on PP10M/day were found with both models (Fig. 8-11), caused by higher detection rates at days before hypothetical pile-driving. This might be due to phenological shifts or simply representing a statistical artefact. In contrast, neither with distance class 2, nor with class 3 such an effect was detectable (Tab. 8-13, Fig. 8-12, Fig. 8-13).

Overall effects of pile-driving activities: Hourly resolution

GAMs were calculated in order to evaluate the overall effects of Pile-driving (including the effect of deterrence) on PPM/h. Significant effects were found with data of distance classes 1 (< 4 km) and 2 (4-10.2 km), but not so with distance class 3 (> 10.2 km). Furthermore, the effects of Position, Hour, and Month were significant with all three distance classes (Tab. 3-9). In detail, the significant effect of Pile-driving (Hour after piling in GAM plots) with distance classes 1 and 2 was mainly caused by a steep increase of PPM/h rates after pile driving (Fig. 3-26, Fig. 3-27). Average detection rates (zero line in GAM plots) were reached 20 hours after pile-driving with distance class 1, with a further increase of rates until 35 hours after pile driving (blue segment in Fig. 3-26). The pattern was similar with distance class 2, however, reaching the average already nine hours after pile-driving and subsequent fluctuation of rates (Fig. 3-27). No effect became visible with distance class 3 (Fig. 3-28). Daily activity patterns of harbour porpoises (Hour) were similar with all distance classes, showing higher rates at day-time (Fig. 3-26, Fig. 3-27, Fig. 3-28; upper right panel). Significant seasonal patterns (Month), as found with daily detection rates, were also recognised on an hourly base. PPM/h rates increased from April to October with distances classes 1 and 3 (Fig. 3-26, Fig. 3-28), but showed an opposite trend with class 2 (Fig. 3-27).

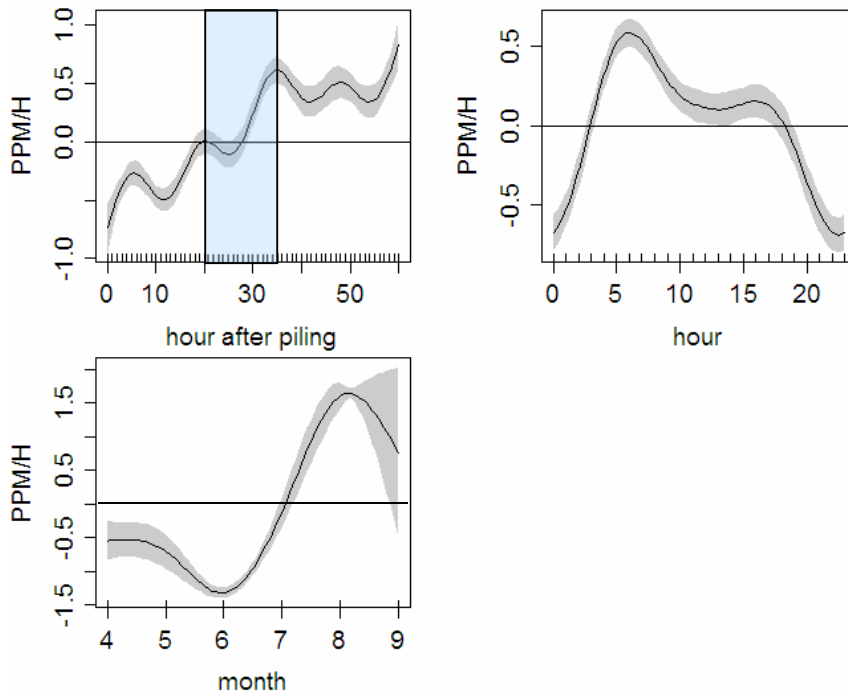

Fig. 3-26: GAM plots (2009 data) for distance class 1 (stations T1-T7), visualising the effects of Pile-driving (here: 'hour after piling'), Hour, and Month on hourly harbour porpoise detection rates PPM/h (horizontal line: overall mean of the model; curve and grey-shaded area: deviation of the model estimate from overall mean, with confidence intervals; blue-shaded area: time segment after pile driving when the mean is reached).

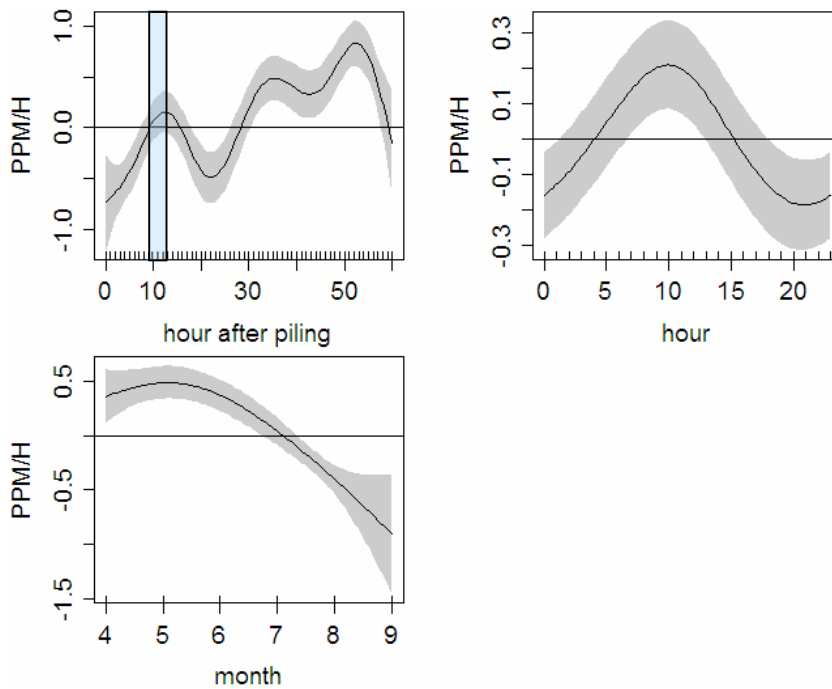

Fig. 3-27: GAM plots (2009 data) for distance class 2 (stations T8, T13), visualising the effects of Pile-driving (here: 'hour after piling'), Hour, and Month on hourly harbour porpoise detection rates PPM/h (see Fig. 3-26 for further information).

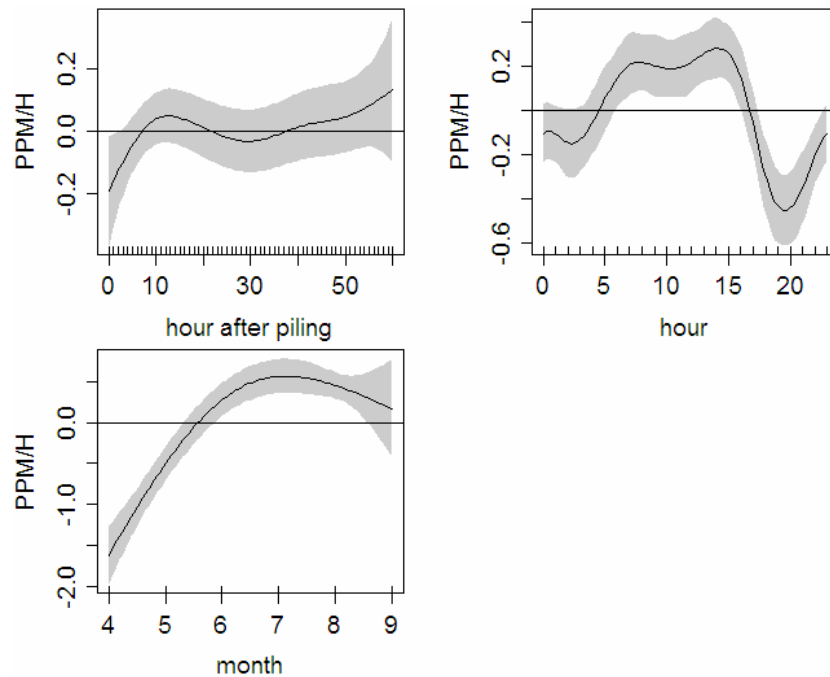

Fig. 3-28: GAM plots (2009 data) for distance class 3 (stations T9-T11), visualising the effects of Pile-driving (here: 'hour after piling'), Hour, and Month on hourly harbour porpoise detection rates PPM/h (see Fig. 3-26 for further information).

Tab. 3-9: GAM results (2009 data) regarding distance-dependent effects of the explanatory variables Pile-driving (Hour after piling; bold), Hour, Month, Position, and Year on PPM/h; for the factors Year and Position degrees of freedom (df), for the smoothing factors Pile-driving, Hour, and Month error degrees of freedom (edf) are given.

Response variable: PPM/h						
Distance class	Variable	df/edf	F	p value	% explained	
1 (< 4 km)	Year	1	2.2	0.14	33.3 %	
	Position	6	167.3	<0.001		
	Pile-driving	8.9	45.4	<0.001		
	Hour	6.1	41.1	<0.001		
	Month	3.9	512.9	<0.001		
2 (4-10.2 km)	Year	1	4.8	0.03	12.0 %	
	Position	1	8.5	<0.05		
	Pile-driving	8.7	12.5	<0.001		
	Hour	2.7	4.3	<0.001		
	Month	2.9	15.7	<0.001		
3 (> 10.2 km)	Year	1	10.8	<0.01	27.4 %	
	Position	3	99.8	<0.001		
	Pile-driving	4.1	1.4	0.23		
	Hour	6.5	8.2	<0.001		
	Month	2.8	47.7	<0.001		

Overall effects of pile-driving activities: Waiting times

Waiting times were defined as any interval of at least 10 minutes length between two subsequent harbour porpoise detections. At nearly all POD stations the 1st Waiting times after real Pile-driving events in 2009 were significantly longer than after hypothetical Pile-driving events applied to 2008 data (Tab. 3-10; see Section 2.4.7, p. 37). Regarding 5th Waiting times significant differences occurred in only three cases, whereas 10th Waiting times showed no difference anymore (Tab. 3-10).

Tab. 3-10: Non-parametric Wilcoxon-Mann-Whitney U-test results regarding comparisons of 1st, 5th, and 10th Waiting times after Pile-driving events in 2009 with those of hypothetical Pile-driving events in 2008; significant results in bold.

Position	1 st Waiting time			5 th Waiting time			10 th Waiting time		
	N	Z	P	N	Z	P	N	Z	P
T1	38.28	-4.3	<0.001	20.14	-2.2	<0.05	18.14	-0.5	0.61
T2	49.24	-4.2	<0.001	30.14	-1.4	0.17	21.80	-1.8	0.08
T3	44.28	-4.5	<0.001	22.19	-2.3	<0.05	13.10	-1.0	0.34
T4	47.11	-4.8	<0.001	24.90	-0.2	0.89	17.60	-1.5	0.14
T5	48.34	-2.0	<0.001	24.90	-0.5	0.61	15.19	-0.6	0.54
T6	51.32	-4.2	<0.001	26.22	-0.2	0.85	16.14	-0.3	0.79
T7	51.32	-4.1	<0.001	27.17	-2.8	<0.01	15.12	-1.3	0.22
T8	50.90	-3.9	<0.001	29.40	-0.5	0.65	21.20	-0.5	0.69
T9	64.46	-0.1	0.93	37.26	-0.6	0.56	29.14	-0.1	0.95
T10	57.14	-2.5	<0.05	46.12	-0.4	0.69	35.90	-1.3	0.22
T11	45.17	-2.3	<0.05	38.12	-0.7	0.50	33.90	-0.1	0.95
T12	54.43	-2.3	<0.05	37.27	-1.0	0.32	24.19	-1.1	0.29

The 1st Waiting time was defined as the time-span until a harbour porpoise signal was detected again at a certain POD position after a pile-driving event took place. However, it did not indicate that porpoise activities after that time reached levels prior to pile-driving activities. In order to get an idea of that time-span, medians of those subsequent Waiting times in 2009 being significantly different from those in 2008 were summed up for each position (Tab. 3-11). Values ranged between 10.8 and 70.5 h (mean 26.1 h, median 19.7 h; Tab. 3-21) with distance class 1 (T1-T7), between 8.1 and 24.1 h (mean and median 16.1 h) with distance class 2 (T8 and T12), and between 0 and 6.4 h (mean 3.5 h, median 4.0 h) with distance class 3 (T9-T11). Interestingly, no significant effect was detectable at the most distant position T9 (on average 21 km distance from pile-driving).

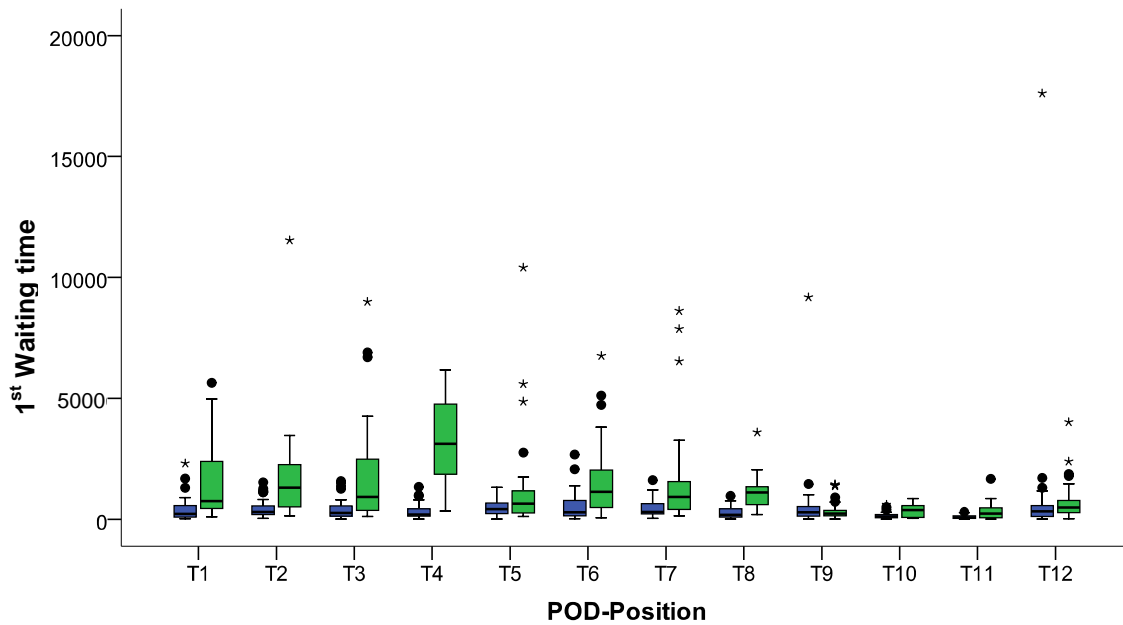

Fig. 3-29: Boxplots of 1st Waiting times after real Pile-driving events in 2009, compared to hypothetical Pile-driving events in 2008 for all POD positions (distance to pile-driving: see Tab. 3-11).

1st Waiting times mostly overlapped with Pile-driving events which often extended to several hours. Since the goal was to assess the duration of the effect after Pile-driving events, in a next step subsequent Waiting times including Truncated 1st Waiting times of 2008 and 2009 were compared. No significant difference could be demonstrated for the most distant positions T9 and T10, as well as for T12 (Tab. 3-12). Values ranged from 3.4 to 31.7 h (mean 12.5 h, median 9.0 h; Tab. 3-21) with distance class 1 (T1-T7), from 0 to 11.7 h (mean and median 5.9 h) with distance class 2 (T8 and T12), and from 0 to 1.3 h (mean 0.4 h, median 0 h) with distance class 3 (T9-T11).

Tab. 3-11: Significance of Wilcoxon-Mann-Whitney U-test results regarding comparisons of 1st to 6th Waiting time after Pile-driving events in 2009 with those after hypothetical Pile-driving events in 2008; duration of effect: summed medians of subsequent significantly different Waiting times; significance levels: ***: $p \leq 0.001$, **: $p \leq 0.01$, *: $p \leq 0.05$, n.s: $p > 0.05$; average distances of stations to pile-driving are given.

Position	1 st	2 nd	3 rd	4 th	5 th	6 th	Sum of Waiting times (min)	Sum of Waiting times (h)
T1 (1.7 km)	***	n.s.					757	12.6
T2 (2.0 km)	***	*	n.s.				1787	24.8
T3 (2.2 km)	***	**	**	n.s.			1182	19.7
T4 (2.2 km)	***	**	**	n.s.			4229	70.5
T5 (2.5 km)	*	n.s.					646	10.8
T6 (2.8 km)	***	n.s.					1131	18.8
T7 (3.2 km)	***	**	*	*	**	n.s.	1575	26.2
T8 (8.3 km)	***	*	**	n.s.			1445	24.1
T9 (21.0 km)	n.s.						0	0
T10 (16.4 km)	*	n.s.					384	6.4
T11 (15.7 km)	*	n.s.					238	4.0
T12 (9.1 km)	*	n.s.					489	8.1

Tab. 3-12: Significance of Wilcoxon-Mann-Whitney U-test results regarding comparisons of Truncated 1st to 6th Waiting time after Pile-driving events in 2009 with those after hypothetical Pile-driving events in 2008; duration of effect: summed medians of subsequent significantly different Waiting times; significance levels: ***: $p \leq 0.001$, **: $p \leq 0.01$, *: $p \leq 0.05$, n.s.: $p > 0.05$.

Position	1 st	2 nd	3 rd	4 th	5 th	6 th	Sum of Waiting times (min)	Sum of Waiting times (h)
T1 (1.7 km)	***	n.s.					264	4.4
T2 (2.0 km)	**	*	n.s.				1128	18.8
T3 (2.2 km)	**	**	**	n.s.			540	9.0
T4 (2.2 km)	***	**	**	n.s.			1902	31.7
T5 (2.5 km)	*	n.s.					204	3.4
T6 (2.8 km)	**	n.s.					276	4.6
T7 (3.2 km)	*	**	*	*	**	n.s.	942	15.7
T8 (8.3 km)	*	*	**	n.s.			702	11.7
T9 (21.0 km)	n.s.	n.s.					0	0
T10 (16.4 km)	n.s.	n.s.					0	0
T11 (15.7 km)	**	n.s.					77	1.3
T12 (9.1 km)	n.s.	n.s.	n.s.				0	0

Short-term BACI analysis

For the BACI (Before-After Control-Impact) approach the most distant POD positions T9-T11 served as Control, whereas the nearby positions T1, T4, and T5 served as Impact (see Section 2.4.7, p. 38). Data were pooled over both *Pile-driving periods* (Tripod and Jacket).

GLM calculation uncovered a significant effect not only of the single variables *Year* and *Area*, but also of the interaction of these two variables on the length of the 1st *Waiting time* (Tab. 3-13), indicating significant differences between Control (T9-T11) and Impact (T1, T4, T5) according to data of 2008 and 2009 (Before and After). This trend is also clearly demonstrated by Fig. 3-30. The BACI effect, here defined as the extension of the 1st *Waiting time* to be explained by *Pile-driving events*, amounted to 1,243 minutes (20.7 h; Tab. 3-14). The same calculation with *Truncated 1st Waiting times* (starting after *Pile-driving events*) uncovered an extension of these by 341 minutes (5.7 h; Tab. 3-15).

Tab. 3-13: GLM results indicating significant effects of the variables *Year* (Before: hypothetical Pile-driving events in 2008; After: real Pile-driving events in 2009) and *Area* (Control: T9-T11; Impact: T1, T4, T5), the interaction of these, and *Position* on the length of the 1st *Waiting time*.

Response variable: 1 st Waiting time			
Explanatory variable	df	Chi ²	p
Year (Before – After)	1	72.8	<0.001
Area (Control – Impact)	1	55.8	<0.001
Position			<0.001
Year * Area	1	15.5	<0.001

Tab. 3-14: *BACI effect of the 1st Waiting time (in minutes: mean of medians per position) between Control and Impact, taking into account Year (Before and After); it is calculated by the Before-After difference at the Impact area (IA – IB = ID) minus that difference at the Control area (CA – CB = CD), resulting in the formula: BACI = ID – CD.*

	Control (T9, T10, T11)	Impact (T1, T3, T4)	BACI effect (min)
Before (2008)	158 (CB)	229 (IB)	+ 1243
After (2009)	288 (CA)	1602 (IA)	

Tab. 3-15: *BACI effect of the Truncated 1st Waiting time (in minutes: mean of medians per position) between Control and Impact, taking into account Year (Before and After); calculation: see Tab. 3-14.*

	Control (T9, T10, T11)	Impact (T1, T3, T4)	BACI effect (min)
Before (2008)	67	96	+ 341
After (2009)	78	448	

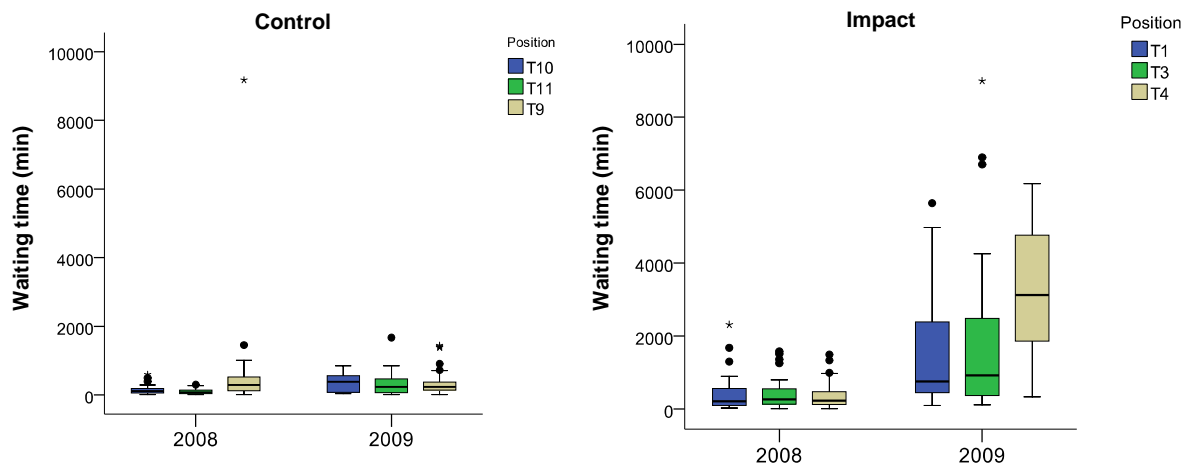

Fig. 3-30: *Boxplots of the differences of the 1st Waiting times between 2008 (Before) and 2009 (After), both for Control and Impact; these data were used for calculation of the BACI effect in Tab. 3-14.*

Effects of construction type/pile-driving duration: Hourly resolution

In order to evaluate the effects of different Foundation types (Tripod, Jacket) on hourly harbour porpoise detection rates PPM/h, GAMs were calculated separately for each of the two construction types.

Tab. 3-16: GAM results (only Tripod pile-driving) regarding distance-dependent effects of the explanatory variables *Pile-driving* (Hour after piling; bold), *Hour*, *Month*, and *Position* on PPM/h; for the factor *Position* degrees of freedom (df), for the smoothing factors *Pile-driving*, *Hour*, and *Month* error degrees of freedom (edf) are given.

Tripod: Response variable: PPM/h						
Distance class	Variable	df/edf	F	p value	% explained	
1 (< 4 km)	<i>Position</i>	6	47.3	<0.001	28.3 %	
	<i>Pile-driving</i>	8.8	48.5	<0.001		
	<i>Hour</i>	8.9	11.9	<0.001		
	<i>Month</i>	2.0	12.7	<0.001		
2 (4-10.2 km)	<i>Position</i>	1	107.2	<0.001	34.1 %	
	<i>Pile-driving</i>	8.8	7.0	<0.001		
	<i>Hour</i>	8.8	3.1	<0.001		
	<i>Month</i>	1.8	8.5	<0.001		
3 (> 10.2 km)	<i>Position</i>	2	14.5	<0.001	17.8 %	
	<i>Pile-driving</i>	6.6	4.6	<0.001		
	<i>Hour</i>	4.0	7.7	<0.001		
	<i>Month</i>	2.0	37.8	<0.001		

Tripod pile driving (24th of April to 31st of May, 2009), characterised by few long-lasting *Pile-driving events* (about 5 h), produced a significant effect of the explanatory variable *Pile-driving* on the response variable PPM/h for all three distance classes (Tab. 3-16). The same was true for the other three investigated explanatory variables *Position*, *Hour*, and *Month*. The minimum duration of the effect, defined as the point where the model curve reached again the overall mean (zero), decreased from distance class 1 (18 h) to classes 2 and 3 (about 6-9 h) (Fig. 3-31 to Fig. 3-33). The maximum duration, here defined by the first maximum that the model curve reached after crossing the zero line, similarly decreased from distance class 1 (45 h) to classes 2 and 3 (11-18 h).

Jacket pile driving (15th of June to 26th of August, 2009), characterised by shorter and more frequent *Pile-driving events*, produced partly different results. The significant effect of *Pile-driving* lasted similarly long for distance class 1 (18-34h; Fig. 3-34) and class 2 (10-12 h; Fig. 3-35). However, the effect of *Pile-driving* was not significant for distance class 3 (Fig. 3-36).

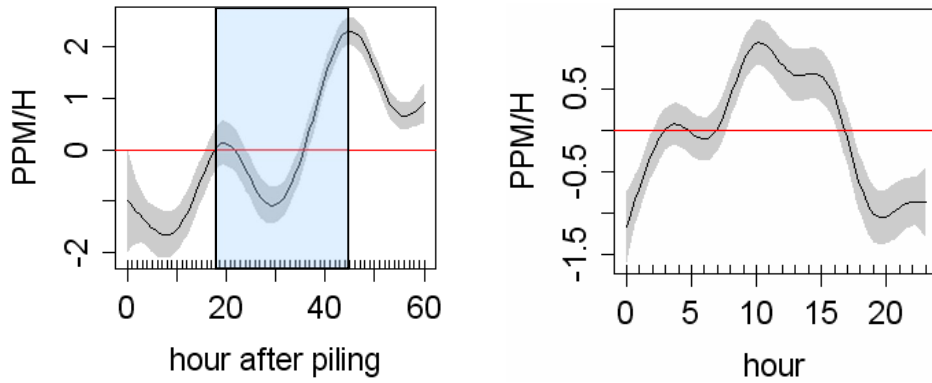

Fig. 3-31: GAM plots (Tripod data) for distance class 1 (stations T1-T7), visualising the effects of Pile-driving (here: 'hour after piling') and Hour on hourly harbour porpoise detection rates PPM/h (see Fig. 3-26 for further information).

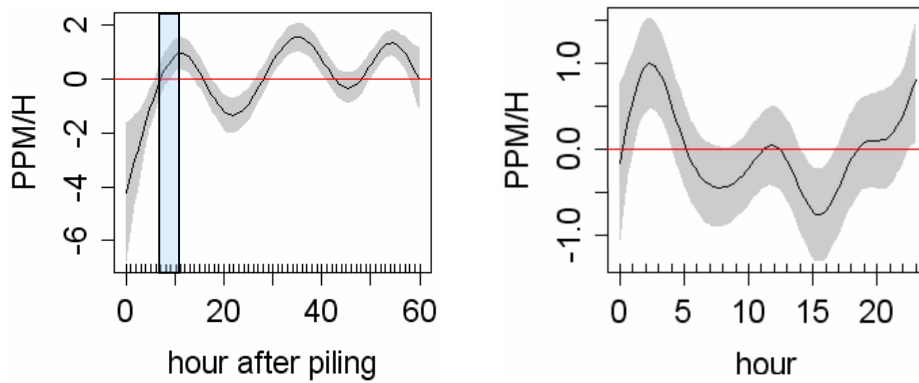

Fig. 3-32: GAM plots (Tripod data) for distance class 2 (stations T8 and T12), visualising the effects of Pile-driving (here: 'hour after piling') and Hour on hourly harbour porpoise detection rates PPM/h (see Fig. 3-26 for further information).

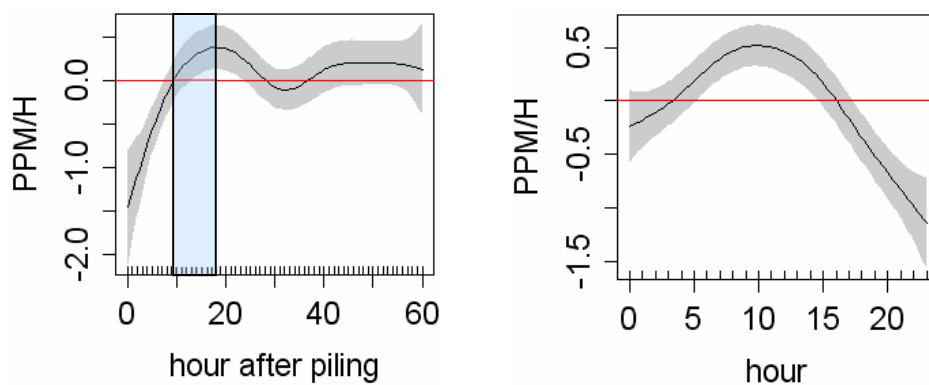

Fig. 3-33: GAM plots (Tripod data) for distance class 3 (stations T9-T11), visualising the effects of Pile-driving (here: 'hour after piling') and Hour on hourly harbour porpoise detection rates PPM/h (see Fig. 3-26 for further information).

Tab. 3-17: GAM results (only Jacket pile-driving) regarding distance-dependent effects of the explanatory variables **Pile-driving** (Hour after piling; bold), Hour, Month, and Position on PPM/h; for the factor Position degrees of freedom (df), for the smoothing factors Pile-driving, Hour, and Month error degrees of freedom (edf) are given.

Jacket: Response variable: PPM/h					
Distance class	Variable	df/edf	F	p value	% explained
1 (< 4 km)	<i>Position</i>	6	29.5	<0.001	36.9 %
	Pile-driving	9.0	29.5	<0.001	
	Hour	8.7	31.4	<0.001	
	<i>Month</i>	2.0	404.2	<0.001	
2 (4-10.2 km)	<i>Position</i>	1	52.4	<0.001	19.2 %
	Pile-driving	8.2	6.0	<0.001	
	Hour	8.7	6.4	<0.001	
	<i>Month</i>	2.0	14.5	<0.001	
3 (> 10.2 km)	<i>Position</i>	2	181.8	<0.001	45.3 %
	Pile-driving	4.8	1.3	0.269	
	Hour	8.9	7.7	<0.001	
	<i>Month</i>	1.5	33.3	<0.001	

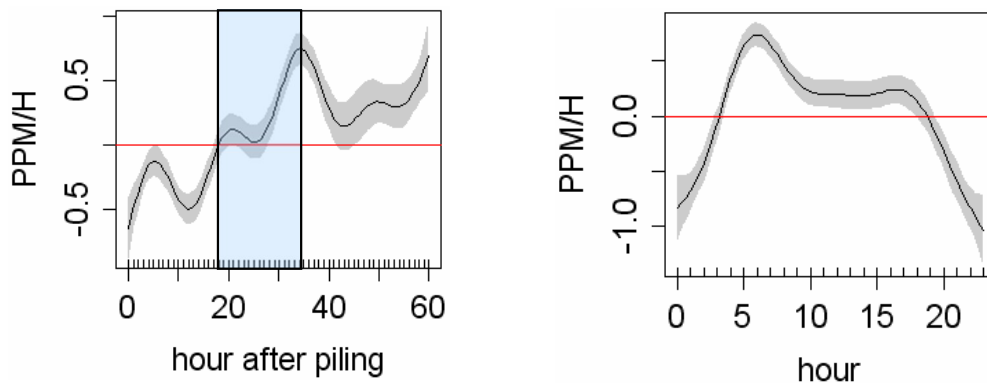

Fig. 3-34: GAM plots (Jacket data) for distance class 1 (stations T1-T7), visualising the effects of Pile-driving (here: 'hour after piling') and Hour on hourly harbour porpoise detection rates PPM/h (see Fig. 3-26 for further information).

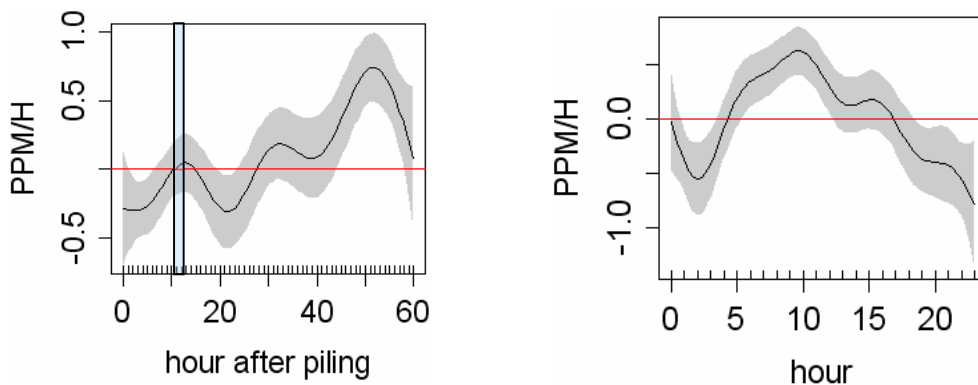

Fig. 3-35: GAM plots (Jacket data) for distance class 2 (stations T8 and T12), visualising the effects of Pile-driving (here: 'hour after piling') and Hour on hourly harbour porpoise detection rates PPM/h (see Fig. 3-26 for further information).

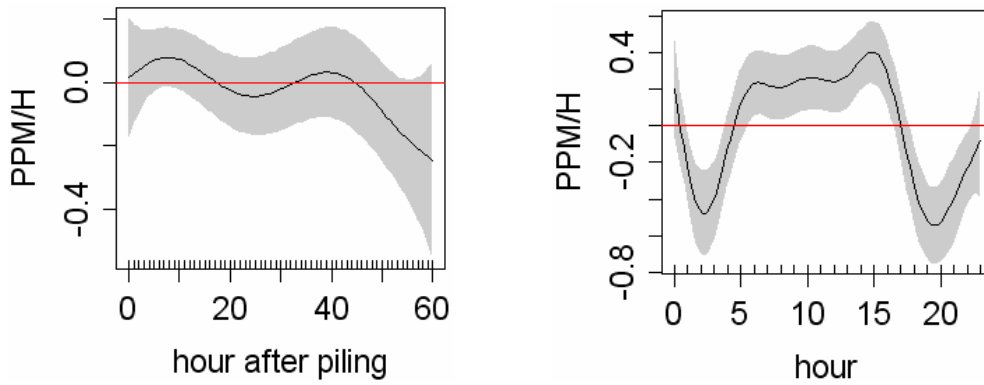

Fig. 3-36: GAM plots (Jacket data) for distance class 3 (stations T9-T11), visualising the effects of Pile-driving (here: 'hour after piling') and Hour on hourly harbour porpoise detection rates PPM/h (see Fig. 3-26 for further information).

Tab. 3-18 summarises the temporal effects of pile-driving (including effects of deterrence) of different types on hourly harbour porpoise detection rates PPM/h, according to GAM calculations.

Tab. 3-18: Duration of the effects of foundation type (Tripod and Jacket: separate and combined) on hourly harbour porpoise detection rates PPM/h.

Distance class	Tripod Duration of effect	Jacket Duration of effect	All pile-drivings Duration of effect
1 (< 4 km: ø 2.4 km)	18-45 h	20-35 h	18-34 h
2 (4-10.2 km: ø 8.3-9.1 km)	6-11 h	9-13 h	6-12 h
3 (> 10.2 km: ø 16.6 km)	6-18 h	-	-

Effects of construction type/pile-driving duration: Waiting times

The effect of the duration of *Pile-driving events* according to different construction types (Tripod: 24.4.2009 to 1.6.2009; Jacket: 15.6.2009 to 26.8.2009) on *Waiting times* was analysed.

The Tripod phase was characterised by few breaks which reduced the number of available *Waiting times*, hence the interpretability of the Tripod dataset. Positions T3, T5, T7, and T8 were not analysed due to insufficient data. At the remaining eight stations the median, mean, and maximum of the 1st *Waiting times* were always higher with the Tripod *Pile-driving events* in 2009, compared to hypothetical *Pile-driving events* in 2008 (Tab. 3-19). The difference was always significant except for the most distant station T9 (21 km) and for T12 (9.1 km).

Tab. 3-19: Non-parametric Wilcoxon-Mann-Whitney U-test results regarding comparisons of 1st Waiting times after Pile-driving events in 2009 (Tripod) with those of hypothetical Pile-driving events in 2008; significant results in bold; also shown: median, mean and maximum for eight POD positions with sufficient data.

Position	N		Test results		Median		Mean		Maximum	
	2008	2009	Z	P	2008	2009	2008	2009	2008	2009
T1 (1.7 km)	7	5	-2.52	<0.05	755	2361	798	2559	2313	5646
T2 (2.0 km)	5	3	-2.24	<0.05	240	2780	209	5607	314	11537
T3 (2.2 km)										
T4 (2.2 km)	3	5	-2.24	<0.05	201	3123	192	4624	1335	6178
T5 (2.5 km)										
T6 (2.8 km)	6	5	-2.74	<0.01	119	4731	226	3897	678	6760
T7 (3.2 km)										
T8 (8.3 km)										
T9 (21.0 km)	8	6	0.39	0.70	731	882	642	849	1011	1445
T10 (16.4 km)	6	7	-3	<0.01	132	518	114	513	213	822
T11 (15.7 km)	4	8	-2.71	<0.01	65	531	110	651	144	1671
T12 (9.1 km)	6	7	-1.86	0.06	340	1473	518	1589	1173	4018

Tab. 3-20: U-test results regarding comparisons of 1st Waiting times after Pile-driving events in 2009 (Jacket) with those of hypothetical Pile-driving events in 2008; significant results in bold; further shown: median, mean and maximum for each POD position.

Position	N		Test results		Median		Mean		Maximum	
	2008	2009	Z	P	2008	2009	2008	2009	2008	2009
T1 (1.7 km)	31	23	-4.08	<0.001	172	605	328	1224	1681	4977
T2 (2.0 km)	45	21	3.40	<0.001	318	1027	464	1257	1530	3462
T3 (2.2 km)	44	24	3.88	<0.001	269	638	392	1246	1577	6707
T4 (2.2 km)	44	6	3.43	<0.001	226	2393	340	2231	1335	3376
T5 (2.5 km)	47	28	1.57	0.12	430	605	476	733	1327	2757
T6 (2.8 km)	45	27	3.13	<0.01	295	928	555	1178	2673	3809
T7 (3.2 km)	51	26	3.20	<0.01	305	843	431	978	1616	3272
T8 (8.3 km)	50	7	3.23	<0.01	181	983	266	1150	964	3596
T9 (21.0 km)	56	40	0.10	0.92	224	237	305	297	1456	1379
T10 (16.4 km)	51	7	-0.31	0.76	105	76	143	242	598	857
T11 (15.7 km)	41	9	-0.81	0.42	72	68	93	345	302	238
T12 (9.1 km)	48	36	1.70	0.09	314	389	386	512	1706	1793

As for the Jacket phase, a significant effect was detectable only up to a distance of 8.3 km (T8). No significant difference was found at the more distant stations T9-T12 (Tab. 3-20).

Similarly to calculations in the Section on the overall effects of pile-driving activities on *Waiting times* (p. 74), the time-span after which porpoise activities reached levels prior to pile-driving activities was assessed by summing up medians of subsequent *Waiting times* for each of the two construction periods (Tripod and Jacket) in 2009 that were significantly different from those in 2008.

A considerable difference between the effects of Tripod and Jacket *Pile-driving events* was uncovered, both with means and medians (Tab. 3-21). The negative effect of Tripod *Pile-driving events* lasted 2-3 times longer with distance class 1 and inclusion of uncut *1st Waiting times*. With the median and inclusion of *Truncated 1st Waiting times* the effect lasted over five times longer with Tripod *Pile-driving events* at short distance, compared to Jacket *Pile-driving events*. As for the furthest distance class 3, a significant negative effect only occurred with Tripod *Pile-driving events*.

Tab. 3-21: *Effect length of Pile-driving events (Tripod, Jacket, and both together), measured by means and medians (over all positions of a certain distance class) of subsequent Waiting times with significant differences between 2008 and 2009. *) only one position (T12) with no significant effect.*

	Distance class	Tripod		Jacket		All Pile-driving events	
		Effect incl. pile-driving	Effect after pile-driving	Effect incl. pile-driving	Effect after pile-driving	Effect incl. pile-driving	Effect after pile-driving
Mean	1 (< 4 km)	54.2 h	13.1 h	21.2 h	8.1 h	26.2 h	12.5 h
	2 (4-10.2 km)	0 h *)	0 h *)	14.1 h	9.0 h	16.1 h	5.9 h
	3 (> 10.2 km)	5.8 h	1.4 h	0 h	0 h	3.5 h	0.4 h
Median	1 (< 4 km)	49.2 h	16.5 h	15.5 h	3.1 h	19.7 h	9.0 h
	2 (4-10.2 km)	0 h *)	0 h *)	14.1 h	9.0 h	16.1 h	5.9 h
	3 (> 10.2 km)	8.6 h	0 h	0 h	0 h	4.0 h	0 h

The *Pile-driving periods* Tripod and Jacket mainly differed by the average duration and number of strokes during *Pile-driving events*. In order to evaluate whether the *number of strokes*, respectively *Pile-driving minutes* in the previous 24 hours had a significant effect on *1st Waiting times*, respectively *Truncated 1st Waiting times*, we computed Spearman rank correlations of the former two parameters on the latter two with distance class 1 (Fig. 3-37).

In all four cases significant correlations were found ($p < 0.01$): the higher the pile-driving activity according to *Pile-driving minutes* in the previous 24 hours, the longer was the time-span until harbour porpoises were detected again in the area.

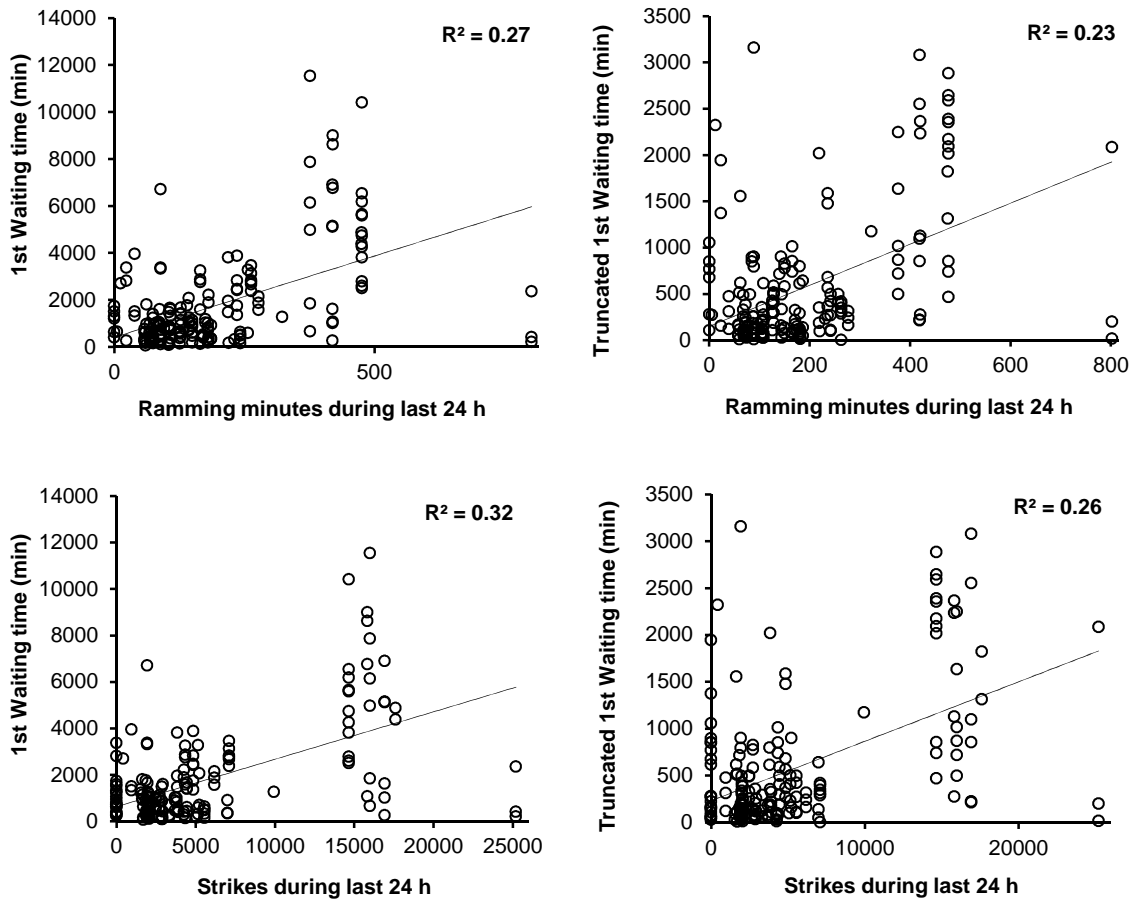

Fig. 3-37: Correlation of 1st Waiting times (upper panels: uncut; lower panels: truncated) at stations of distance class 1 with the number of strokes (right panels), respectively pile-driving minutes (left panels) during the previous 24 hours.

Sound levels and distances of effects

The sound levels at which displacement effects on harbour porpoises started are summarised in Tab. 3-22. Taking into account both detection rates and *Waiting times* for all pile-drivings, harbour porpoises were affected until distances of about 9.0 km, or 16.6 km (medians of both methods), corresponding to noise levels of 150 dB_{SEL50}, or 143 dB_{SEL50}, respectively (span: 142-152 dB_{SEL50}), according to the empirical sound propagation function developed by itap GmbH for the Trianel Windpark Borkum, Phase I area close to the alpha ventus area (in: Diederichs et al. 2014).

The duration of pile-driving activities was important regarding displacement effects on harbour porpoises at OWF alpha ventus. With shorter *Pile-driving events* of about 1 h, displacement of harbour porpoises started at 150-151 dB_{SEL50} i.e., (median distance to pile-driving of 8.3-9.1 km), with a span of 148-152 dB_{SEL50}, whereas with longer *Pile-driving events* of about 5 h displacement started at 143 dB_{SEL50} (median distance of 16.6 km), ranging from 138-144 dB_{SEL50}. Hence, sound levels of response were about 7-8 dB_{SEL50} lower on average when *Pile-driving events* lasted for 5 h instead of 1 h.

Tab. 3-22: Distances (median [**bold**], minimum, maximum) and according noise levels (dB_{SEL50}) of response of harbour porpoises to Pile-driving events of different duration (= different foundation types at OWF alpha ventus); DistCl: Distance class (only for detection rates; for Waiting times: Station).

	Pile-driving events	DistCl/ Station	Dist [m] min	Dist [m] median	Dist [m] max	dB _{SEL} , D min	dB _{SEL} , D median	dB _{SEL} , D max
Detection rates PPM/h	All	2	7,459	8,974	10,125	152	150	148
	Long (Tripod: 5h)	3	14,209	16,558	22,566	144	143	138
	Short (Jacket: 1h)	2	7,487	8,366	10,125	152	151	148
Waiting times	All	T10	15,647	16,653	17,560	143	143	142
	Long (Tripod: 5h)	T10	15,647	16,653	17,560	143	143	142
	Short (Jacket: 1h)	T8	7,487	9,065	9,975	152	150	148

3.3.3 Phase III

Short-term effects of OWT in operation

No short-term negative effects of OWT operating under full load on harbour porpoise detection rates were found in the 'Impact Area' in close vicinity of the turbines, compared to times with lower or no turbine activity (Fig. 3-38; Höschle et al. 2011). Detection rates were even slightly higher at higher turbine loads. Hence, no negative effect of turbine load was found.

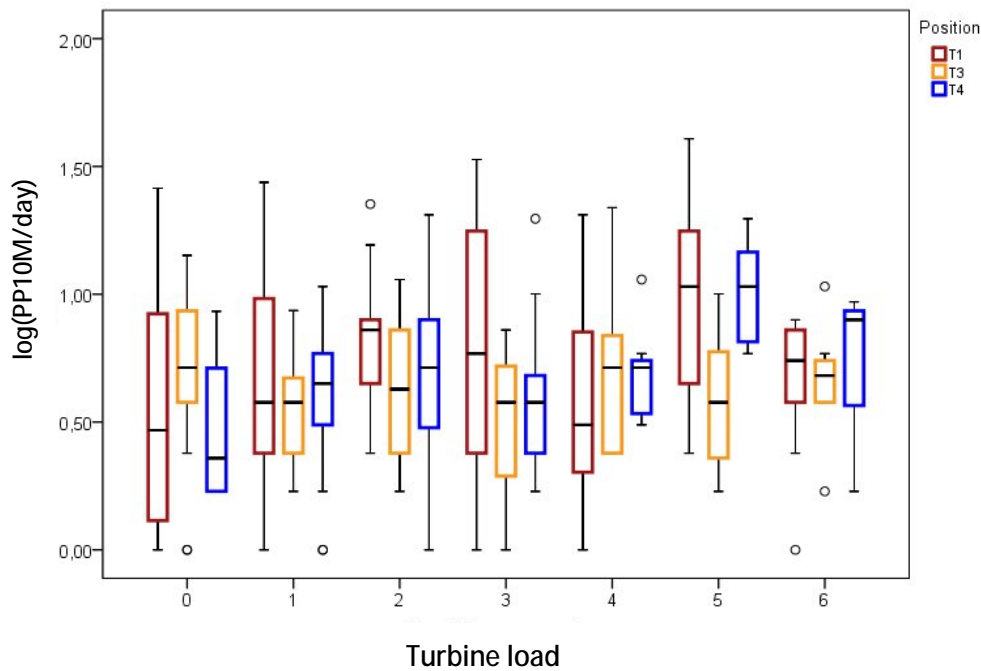

Fig. 3-38: Boxplot of PP10M/day detection rates in the 'Impact Area' in relation to turbine load (full load = 6).

Long-term effects of OWT in operation

A long-term increase of harbour porpoise detection rates in close vicinity to the windfarm alpha ventus during Phase III was extensively demonstrated by long-term phenological, time-series, and BACIP analyses in the section on overall results across phases (Section 3.3.1). It is referred to that section for further information.

4 DISCUSSION

4.1 Project alpha ventus

This 5-year study was the first to investigate the effects of the construction and operation of a German offshore windfarm (OWF) on marine mammals by completely implementing the Standards for Environmental Impact Assessments (StUK3) of the German Federal Maritime and Hydrographic Agency (BSH 2007), including a baseline survey before windfarm construction. The effects of the construction and operation of OWF alpha ventus on marine mammals were analysed by comparing data of the construction phase (Phase II: 2008/09) and operation phase (Phase III: 2010-2013) to those of a baseline survey (Phase I: 2008). The results of the study also served as a basis for evaluating StUK3 as to its appropriateness and efficiency.

Before construction works for OWF alpha ventus started, it was hypothesised that construction and operation of this windfarm would not have significant adverse effects on harbour porpoises and other marine mammals in the region (BSH 2001). Nevertheless, as no experience with established windfarms was available at that time, some concerns remained regarding displacement of animals a) during and after pile driving due to noise emissions, b) during operation of the windfarm due to noise emissions of wind turbines, and c) due to increased ship traffic along with turbine installation and maintenance works. On the other hand, it was speculated whether exclusion of fisheries from the windfarm area and newly formed hard substrate habitats (turbine foundations) might attract marine mammals.

When evaluating the results of the monitoring of alpha ventus it is important to consider that from September 2011 to March 2012 foundations for a second offshore windfarm, Trianel Windpark Borkum, Phase I (BW2), were piled only 8 km east of alpha ventus. At BW2, 40 Tripod foundations were built. Though noise mitigation using a bubble curtain was implemented during pile driving for BW2 (Diederichs et al. 2014), construction works still might have affected harbour porpoises during the Operation phase of alpha ventus.

4.2 Methodology

Three different methods were used to assess the presence of marine mammals in the alpha ventus project area during the project phases. Regarding seals, only visual methods, i.e. aerial and vessel-based transect surveys, were applicable. Harbour porpoises were additionally detectable by Passive Acoustic Monitoring (PAM).

Aerial transect surveys are the preferred method to assess absolute densities of marine mammals over large areas (Gunlaugsson et al. 1988; Heide-Jørgensen et al. 1992, 1993; Hammond et al. 1995; Adelung et al. 1997; Diederichs et al. 2002; Grünkorn et al. 2004; Scheidat et al. 2003, 2004; Thomsen et al. 2004; Gilles et al. 2006, 2007, 2010, 2011). However, such surveys are *snapshot* studies delivering highly detached data at larger spatial scales. Since they can only provide data from given survey days, their temporal resolution is low. Factors that change animals' distribution during the survey (e.g., time of day, food availability, patchiness of animal distribution, or un-

known random processes) are difficult to determine, and thus data obtained by aerial surveys offer only moderate potential for conclusions on impacts lasting for a shorter time-span than the duration of a survey (e.g., moderate pile driving effects). Due to their snapshot character, only in rare cases of temporal coincidence these data can be used to directly detect the range of pile-driving effects on marine mammals. On the other hand, aerial surveys are the only method allowing calculation of absolute densities over large areas. Regarding harbour porpoises, aerial surveys provide valuable information to supplement temporally continuous, but spatially small-scale PAM data, and to allow an interpretation of the latter in a larger spatial context.

Vessel-based surveys, which are snapshot studies like aerial surveys, cover only smaller areas than the latter. Density calculation after the line-transect-distance-sampling method (Buckland et al. 2001), is mostly not applicable with vessel-based data due to more severe uncertainties than with aerial surveys. Observations from vessels are especially prone to seastate and visibility differences: at wind speeds higher than 2-3 bft a large quantity of individuals might be overseen in the waves. Only dedicated surveys, conducted with much higher effort as demanded by the StUK and including a double platform approach, offer the possibility to come up with reliable density estimates (Hammond et al. 2002, 2013; Viquerat et al. 2014). Still, results may well be biased since animals potentially react to the ship (e.g., Barlow 1988; Polachek & Thorper 1990; Buckland & Turnock 1992; Hammond et al. 1995; Palka 1995; Polachek 1995; Teilmann 1996; Buckland et al. 2001; Teilmann et al. 2013).

In contrast to visual surveys, Passive Acoustic Monitoring (PAM) by Porpoise Detectors (PODs) provides long-term datasets with high temporal resolution, giving rise to the possibility of integrating short-term fluctuations. However, this is put into perspective by the fact that PAM is not applicable for seals, and that POD data are representative only for very small areas: the detection range of PODs is only a few hundred metres (ca. 200 m). PODs being only a few km apart from each other may gain substantially differing data (Diederichs et al. 2008b). For the investigation of harbour porpoises, PAM is thus ideally supplemented by aerial surveys.

Since PAM relies on the detection of echolocation clicks of harbour porpoises, misinterpreting missing clicks as absence is principally possible because animals may just change their behaviour in the proximity of pile driving activities by reducing echolocation during and after pile-driving activities. However, we consider this to be negligible since former studies showed that PAM detection rates were often correlated with absolute densities (Diederichs et al. 2004; Tougaard et al. 2006c; Verfuß et al. 2007; Siebert & Rye 2008; Haelters et al. 2012, 2013), and that densities may be even directly calculated out of POD data (Kyhn et al. 2012). Since echolocation is most important for the animals' orientation, feeding, and communication (e.g., Clausen et al. 2011, Miller & Wahlberg 2013), it is rather unlikely that harbour porpoises would not make use of this system over longer time-spans – especially in the North Sea with its unfavourable visibility conditions. Akamatsu et al. (2007) showed that harbour porpoises use their echolocation system almost continuously. In extreme cases, however, periods of up to 22 minutes without clicks were found in the wild (Linnenschmidt et al. 2013). Due to these considerations, the presence of a *displacement effect* is assumed when PAM detection rates are significantly lowered in response to pile driving noise.

Due to an inevitable shift in PAM methodology from T-POD to C-POD devices in April 2010, a model had to be developed for converting T-POD data into C-POD equivalents. Since both device

types were deployed together at some stations for certain periods, we were able to model a conversion factor. In consequence, it was possible to analyse combined data from both devices, for example to compare phenological data of all three project phases. Such comparisons were difficult to conduct in the past when a combined dataset of joint deployments of both POD types was lacking (e.g., Siebert et al. 2013).

Concerning the application of digital video techniques the two surveys conducted in April 2013 provided sighting rates which are well in line with those of visual surveys and it can be concluded that the video technique is capable in detecting marine mammals. Sample size of both surveys is considered as sufficient for density calculations. The density calculation which was applied for this report was straightforward by only considering the availability bias from literature data. The obtained densities correspond closely to four visual surveys conducted in January to March 2013 and may indicate that both methods provide comparable results. A cautionary note, however, is needed at this stage as porpoise densities have shown seasonal increases in the same period in previous years which was not detected by the video surveys. Although it is quite possible that this is due to natural variation of porpoise abundance in the area and POD data until April 2013 did not indicate marked changes in porpoise abundance, a methodological bias cannot be fully excluded. While for visual surveys solid methods to correct for biased data are available which provide consistent results, this has not been shown yet for digital survey techniques and more work needs to be done to account for the effects of varying survey conditions (light, seastate) in order to develop a standardized method for density calculations from digital surveys.

4.3 Harbour porpoise

4.3.1 Presence, density, phenology, calves

Harbour porpoises were almost continuously present in the alpha ventus project area. Overall detection rates of 17% *PP10M/day*, as found during the project, were basically in the range of rates from areas with relatively high harbour porpoise densities. Brandt et al. (2008) found a 6-months average of 20% *PP10M/day* in an area west of Sylt. At Horns Rev, Tougaard et al. (2006a) and Diederichs et al. (2008b) registered overall daily detection rates of 23% *PP10M/day*. A year later, with the project Horns Rev II rates of 18.5% *PP10M/day* were assessed by T-PODs in the same area (Brandt et al. 2009a, 2011, 2012). By contrast, around Nysted (Baltic Sea), an area with medium harbour porpoise densities, only 7% *PP10M/day* were recorded (Diederichs et al. 2008b). In the Danish North Sea west of Esbjerg Brandt et al. (2009b: FINO III) found highly varying rates, ranging from 4.1% *PP10M/day* to 37.9% *PP10M/day*. Similarly, harbour porpoises were unevenly distributed throughout the alpha ventus project area. The eastern part was an area of medium harbour porpoise densities (*PP10M/day* rates below 10%, and average monthly densities mostly below 1 ind./km², with a maximum of 1.6 ind./km²) whereas the western part, including parts of the Natura 2000 SCI Borkum Reef Ground, showed rates of around 30% *PP10M/day* and average monthly densities being higher than 1 ind./km² for seven out of twelve months (maximum of 2.2 ind./km²). In the area west of Sylt, even higher densities of up to 5 ind./km² were recorded (Gilles et al. 2009, 2010; Brandt et al. 2009b).

Harbour porpoise phenology curves of PAM analyses pointed to different seasonal patterns between 'Borkum Reef Ground' and three other more eastern POD station clusters ('Impact Area', 'Reference close', 'Reference distant'). At 'Borkum Reef Ground' greater differences in detection rates between years could be observed. However, in all years harbour porpoise activities peaked in June and July as well as in December, with minor peaks in March for some years. Lowest detection rates occurred during September. In contrast, the other three station clusters showed a more consistent seasonal pattern over five years. It was characterised by maxima in March and November, and lowest rates in June and July. The seasonal pattern was mostly, but not always congruent over the years within each POD station cluster. Differences in the seasonal pattern between locations most likely reflected a high small-scale variability (e.g., Diederichs et al. 2008b). In 2012, a considerable difference in detection rates could be observed compared to all previous years, which was consistent over all three clusters: Here, a distinct maximum of detections occurred in May/June, a period when in all previous years detections were low. The reasons for this additional peak remained unclear.

Aerial survey phenology patterns were mostly congruent with those obtained by PAM, but they still showed some deviations. In the eastern part of the survey area including the windfarm area of alpha ventus ('Aerial East'), a peak in April and a minimum in July were found, similar to the peak in March and the minimum in June/July shown by POD data. However, whereas detection rates during May and June were rather low, porpoise densities based on aerial surveys were only slightly lower when compared to the peak in April. The maximum in July at POD cluster 'Borkum Reef Ground' was found to occur about 1-2 months earlier in the western part of the aerial survey area.

Both methods provided two to three times higher densities/detection rates in the area of the Natura 2000 SCI Borkum Reef Ground, compared to the central and eastern part of the project area. It was not possible to define an exact delineation of the area of higher porpoise abundance by POD data alone. However, aerial surveys indicated that densities increased to the southwest of the alpha ventus windfarm area. This was probably related to different ecological conditions at Borkum Reef Ground, which was suggested to be an important feeding ground for harbour porpoises and grey seals by Gilles et al. (2011). Since it is known that the seasonal distribution of harbour porpoises is often correlated with their prey availability (Sveegaard et al. 2012), the temporal and spatial distribution pattern of potential prey was likely to be different within that area.

Harbour porpoise phenologies as derived from aerial survey data and the POD station clusters 'Impact Area', 'Reference close', and 'Reference distant' were to a good deal congruent to those reported by Camphuysen (2004, 2011) who found a well expressed maximum in February/March and a minimum between April and October near the Dutch coast. A decrease from March to April was also found by our study, but a strong difference between spring/summer and winter sightings, as found by Camphuysen, was less expressed, as sighting rates at alpha ventus project area increased in September already. Nevertheless, the hypothesis of a regular exchange of animals between German and Dutch waters was supported by these data. Phenological patterns similar to those at alpha ventus, with a maximum in late winter/early spring, were also found in Belgium coastal waters (Haelters et al. 2010). We suppose that Dutch and Belgium coastal waters serve as wintering grounds for harbour porpoises, and that our project area may be near the eastern margin of these wintering grounds. In contrast, in areas like Sylt Outer Reef and near the western Danish and Schleswig-Holstein North Sea coastline densities were reported to be highest in sum-

mer (e.g., Scheidat et al. 2004, Gilles et al. 2009, 2010, 2011), and it is assumed that porpoises from areas like alpha ventus or the Dutch coast regularly move to these north-eastern parts of the North Sea in summer. Following this hypothesis, the area around OWF alpha ventus served at least partly as a transit zone for animals moving between south western wintering grounds and north eastern summer grounds.

The phenology as derived from this study is similar to those reported by Gilles et al. (2006, 2007, 2011) and Gilles & Siebert (2009) for 'stratum D', which includes our investigation area, for the years 2002-2011. However, whereas we found almost continuously higher densities and higher PAM detection rates within the Natura 2000 SCI Borkum Reef Ground, this was not always the case in earlier surveys. Generally, the coastal waters off East Frisia, including SCI Borkum Reef Ground, were proposed to be of increasing importance for harbour porpoises due to increasing densities in that region since 2004. This was probably connected to a shift in the overall distribution pattern of this species in the North Sea during the last decades, shown by the two SCANS surveys in 1994 and 2005 (Hammond et al. 2002, 2013). Hammond et al. (2013) discuss this shift by a decline of prey availability in the north (whiting and sandeel), but sustained prey availability in the south (whiting and herring).

The proportion of calves was quite constant at about 10% during all years of investigation. This was within the range of 9-18% for the coast west of Schleswig-Holstein and the area west of Sylt (Germany) reported by Sonntag et al. (1999).

4.3.2 Effects of windfarm construction

Construction works for the offshore windfarm test site alpha ventus took place during a time of the year (spring/summer) when the presence of harbour porpoises was relatively low in the vicinity of the windfarm. Direct effects of pile-driving activities on the presence of harbour porpoises was most accurately assessed by modelling Passive Acoustic Monitoring (PAM) data.

German noise threshold value of 160 dB_{SEL} in 750 m distance to pile driving were exceeded by about 10 dB_{SEL} during pile driving for alpha ventus (Betke & Matuschek 2011); 160 dB_{SEL} were only undercut in 3,200 m distance. Unlike to all offshore windfarm projects in German Waters since 2012 no noise mitigation system was implemented at alpha ventus except partly for one foundation reducing pile-driving noise by 10 dB_{SEL} (Betke & Matuschek 2011). Additional to pile-driving noise also the partly exceptionally long lasting use of deterrence devices before pile driving started have to be considered when interpreting the results of effects of the construction of alpha ventus.

When sound levels exceeded 157 dB_{SEL50}, which happened in up to 4 km distance from pile driving, displacement effects on harbour porpoises lasted for 20-35 h. An effect of at least 9 h duration was found at a distance of about 9 km, corresponding to 150 dB_{SEL50}. At distances larger than 14 km, the result was ambiguous: no effect was detectable with pure detection rates, but with *Waiting times* a response was found at 16.6 km distance (143 dB_{SEL50}). Dähne et al. (2013) found comparable displacement effects up to a distance of 10.8 km (corresponding to 148 dB_{SEL50}), however, with no data between 10.8 km and 23 km distance. Studies at Horns Rev II (Brandt et al. 2009a, 2011, 2012), with slightly higher noise immission than for alpha ventus, caused displacement effects of 24-70 h in 2.6 km distance, and 11-23 h (according to Fig. 1 in Brandt et al. 2011)

in 17.8 km distance from pile-driving (~144-147 dB_{SEL50}), whereas no effect was found in 22 km distance from pile driving. Our results partly contradict those of Tougaard et al. (2009a), who found duration of an effect of only 1.6 h close to construction sites, which did not decrease with increasing distance. These authors proposed for the OWF Horns Rev I that an effect would possibly exceed 20 km. Since both the Horns Rev II study of Brandt et al. (2009a, 2011, 2012) and our study indicated a clear decrease of the duration of the effect with increasing distance from pile driving, it is supposed that our results were more realistic, and that those from Horns Rev I (Tougaard et al. 2009a) may have been based on a too small dataset to describe possible displacement effects sufficiently.

We further demonstrated that – apart from noise levels – duration of pile-driving or number of strikes determined displacement effects on harbour porpoises at OWF alpha ventus. For short *Pile-driving events* of about 1 h, displacement of harbour porpoises was statistically significant until a distance to pile-driving of 8.3-9.1 km, while for longer *Pile-driving events* of about 5 h but similar noise levels (single strike), displacement reached a median distance of 16.6 km. Hence, sound levels for a negative behavioural reaction were up to 7-8 dB_{SEL50} lower on average when *Pile-driving events* lasted for 5 h instead of 1 h. While we consider that for a single strike it is mainly the noise level which determines the strength of a response, the increasing displacement radii of longer piling events are likely to be caused by the fact that animals continuously move further away from the source as piling continues, making displacement effects apparent at lower noise levels. The importance of noise duration for a behavioural response of marine mammals was also proposed by Bailey et al. (2010). Recently, Dähne et al. (2013) showed that the effect of pile-driving was modelled best by taking into account the duration of pile driving.

Lowest noise levels inducing displacement as found by our study (143 dB_{SEL50}) are supported by experimental findings of Lucke et al. (2009) who showed onset of behavioural reactions of a captive harbour porpoise noise levels of > 145 dB_{SEL}. Such levels occurred at distances between > 10 km (146-152 dB_{SEL}) and < 25 km (139-145 dB_{SEL}). A range of displacement of about 20 km with unmitigated pile driving was also calculated by Haelters et al. (2012, 2013) by modelling short-term displacement of harbour porpoises up to a distance of 19 km from pile-driving activities in Belgian waters (relating to 140 dB_{SEL50}). Similar ranges were given by Brandt et al. (2011, 2012) and Tougaard et al. (2009a, b).

During construction of the offshore windfarm Trianel Windpark Borkum, Phase I (BW2), Diederichs et al. (2014) found significant displacement effects on harbour porpoises at noise levels above 144 dB_{SEL50}, being similar to our findings. However, the duration of *Pile-driving events* was not investigated in detail by the BW2 study, as pile-driving lasted only about 1 h (comparable piles with about 2.5 m diameter), and in this respect it resembled Jacket foundation pile-driving for OWF alpha ventus. With respect to the number of strokes, we found a significant correlation for the closest distance class (up to 4 km): the more strokes took place in the previous 24 hours, the longer was the time-span until harbour porpoises were detected again in the area. This was in contrast to the BW2 study where the duration of displacement effects was relatively stable for different noise levels and ranged around 12 h on average.

Aerial surveys provided valuable information to put local PAM data into a regional context. Our study, however, did not detect significant effects of pile-driving by aerial survey data. Based on data of an aerial survey in the alpha ventus area at a single pile-driving day (1st of May, 2009),

Gilles & Siebert (2009) and Dähne et al. (2013) proposed that pile driving noise might displace all harbour porpoises to distances of about 20 km from pile-driving localities on the short term. This phenomenon could not be confirmed by our POD data, as they showed very low detection rates at all stations even before pile-driving started at this particular day. Hence it is unlikely that the distribution pattern revealed by aerial surveys can be attributed only to pile driving. However, similar distances were modelled after aerial survey data by Haelters et al. (2012, 2013) for Belgian offshore windfarms. Brandt et al. (2009b) reported for the proximity of the research platform FINO III (about 90 km west of Sylt) extraordinary high densities of about 4 ind./km² at days before and after a day with pile-driving activity, whereas at the pile-driving day itself densities were much lower (only 0.8 ind./km²), at least up to a distance of 20 km from pile-driving (the range of the survey). However, some animals were still present at distances of only a few kilometres away from the pile-driving location during pile-driving activities. At distances larger than 20 km elevated porpoise densities and detection rates were proposed by some studies (Dähne et al. 2013; Haelters et al. 2012, 2013), and discussed to be attributed to aggregation effects within a zone where animals left the range of displacement effects. Since areas become very large with increasing distance to the pile-driving location, it would be rather speculative to attribute higher densities further apart to pile-driving activities.

Harbour porpoise densities in the western part of the project area were lower from late spring to autumn 2009, compared to the same period in the previous and following years. This finding may indicate displacement effects lasting throughout the construction and turbine installation works in 2009.

Pile-driving activities for OWF Trianel Windpark Borkum, Phase I (Sep 2011 to Mar 2012; distance to alpha ventus stations: 5-20 km) did not affect harbour porpoise detection rates from autumn 2011 onwards. Pile driving for BW2 was quite short on average (about 1 h), and mitigated by big bubble curtains for 31 out of 40 foundations, mostly reducing the radius of displacement of harbour porpoises to less than 5 km around pile-driving (Diederichs et al. 2014). This sufficiently explained the low effect of BW2 pile-driving activities on daily harbour porpoise detection rates at most alpha ventus POD stations. Only at POD station cluster 'Borkum Reef Ground', daily detection rates were lower in autumn 2011, compared to autumn 2009. However, since this was not the case for three other station clusters at similar distance to BW2, the outcome could not directly be addressed to pile driving for BW2.

Displacement of harbour porpoises by construction works for alpha ventus was clearly demonstrated by our study. But how likely was harming of animals? Referring to investigations by Lucke et al. (2009) and Kastelein et al. (2012) onset of a temporary threshold shift (TTS) in harbour porpoise is assumed to be at 165 dB_{SEL} (Tougaard 2013, NOAA 2013) and a permanent threshold shift (PTS) at 180 dB_{SEL}. The TTS level would have been reached at 2 km distance, the PTS level within about 200 m from pile-driving for OWF alpha ventus. Since we registered 32 harbour porpoise positive hours (PPH) coinciding with pile-driving hours at PODs within 2 km distance from construction sites, porpoises might have been exposed to noise levels causing TTS. Due to logistic constraints, no PODs were positioned closer than about 750 m from pile-drivings, thus no data are available for the PTS range. Leopold & Camphuysen (2008) found no evidence that harbour porpoises were physically harmed during the construction works for the Dutch OWF Egmond an Zee. Interestingly, for a related species of delphinids, the false killer whale (*Pseudorca crassidens*), Nachtigall & Supin (2013) demonstrated the ability of an active reduction of the hearing sensitivity

by more than 10 dB after an initial loud sound. Harbour porpoises might similarly be able to protect their hearing system actively after a first loud pile-driving stroke, but this would have to be evaluated by future studies.

In summary, harbour porpoises' results showed short-term displacement in response to pile-driving activities for OWF alpha ventus down to sound levels of about 143 dB_{SEL50}. Effects lasted for up to two days ($\varnothing = 31,5$ h) in close vicinity of less than 4 km from pile driving. Our data indicated that pile-driving duration affects range and duration of displacement. Additional effects of construction and turbine installation works in 2009, exceeding the here presented temporal and spatial scales of direct effects, could not be excluded, since during and after construction works in 2009 densities were also reduced at Borkum Reef Ground. Pile driving for BW2 might somehow have been involved into the slightly decreasing trend at Borkum Reef Ground during the operation phase, which, however, was not found at the other POD station clusters. At the latter, detection rates were highest in 2012. However, since the project area partly functions as a transition zone between summering and wintering grounds, the turnover of animals was generally high here and a shift of distribution patterns must not be seen isolated for this area.

4.3.3 Effects of windfarm operation

More than three years of continuous post-construction monitoring at OWF alpha ventus using PODs allow assessing the spatio-temporal trends in harbour porpoise presence and distribution during the Operation phase. Porpoise activities close to the windfarm area ('Impact area', 'Reference close') were lower during the first two years after OWF construction (2010, 2011), but reached again the level of the baseline survey, or even exceeded it, in 2012. At these stations, detection rates more than doubled during the operation phase. At more distant stations, where any impact of windfarm operation can be excluded ('Reference distant', 'Borkum Reef Ground'), detection rates in 2010 and 2011 were similar to 2008 and increased by only 20% ('Reference distant'), or even decreased by 15% ('Borkum Reef Ground') during the operation phase.

Possible impacts of offshore windfarm operation on harbour porpoises are a matter of ongoing discussions, based on different findings. A long-term negative effect of an offshore windfarm in operation on harbour porpoise detection rates was concluded by Teilmann & Carstensen (2012). These authors found no complete recovery even eight years after construction works for the Nysted Offshore Windfarm in the Danish Baltic Sea. This windfarm consisted of 90 turbines based on gravity foundations, though some sheet piling took place at one foundation. The study suffers from a short baseline survey and no conclusion was drawn which factor might have caused a long-term decrease in harbour porpoises. At the same windfarm, Diederichs et al. (2008b) found no avoidance effect of the OWF in operation. Porpoise detection rates between inside the windfarm compared to only a few hundred metres outside were only different in terms of diurnal activity but not for general presence/absence. Similarly, no difference in the presence of harbour porpoises was detected between POD data from inside and outside the offshore windfarm Horns Rev I (North Sea) (Diederichs et al. 2008b). Yet, in some years the diurnal activity pattern seemed to have shifted towards more nocturnal activity inside the OWFs Nysted and Horns Rev I, whereas outside of these windfarms more daylight activity was recorded (Diederichs et al. 2008b). Diurnal patterns were not investigated by our study. Also no negative effect of operational windfarms on porpoises was reported for the adjacent Rødsand 2 windfarm (Teilmann et al. 2012) and for the

Dutch windfarm Egmond an Zee (Scheidat et al. 2011). Here, even higher detection rates were measured during the operational phase compared with the baseline period, which is discussed to be caused by artificial reef effects and no fishing within the windfarm area.

Several studies regarded the noise of rotating wind turbines as being too low to cause negative reactions of harbour porpoises. At the Belgium offshore windfarm C-Power, Norro et al. (2013) found the operational noise to be only 5-10 dB above background noise. Due to similar findings, Tougaard et al. (2009b) proposed that behavioural reactions of porpoises to turbine noise were unlikely, except for that animals would be very close to the foundations (below 20-70 m). Diederichs et al. (2008b) reported maximum sound pressure levels (SPL) of 110 dB_{SPL} re 1 µPa for OWF Nysted, 114 dB_{SPL} re 1 µPa for OWF Utgrunden, 117 dB_{SPL} re 1 µPa for OWF Horns Rev I, and 110 dB_{SPL} re 1 µPa for OWF Paludans Flak. At those, the frequency peak of turbine noise was 10-15 dB above the threshold level of the porpoise audiogram only at frequencies higher than 800 Hz. It was assumed that the noise should have been clearly audible to animals in 83 m distance from turbines and that it disappeared below background noise in 260 m distance. The authors concluded that the generally low levels of noise emitted, combined with the relatively poor hearing abilities of porpoises at low frequencies, made it unlikely that turbine noise should be audible beyond a few hundred meters. The same authors found no negative effects of turbines in operation on harbour porpoises at OWF Nysted. We could show that at OWF alpha ventus even at highest rotational speed (load) the operation of wind turbines did not negatively affect harbour porpoise detection rates. At alpha ventus, sound levels of turbines in operation rarely exceeded 115 dB_{L50} under full load in 100 m distance (Betke & Matuschek 2012), which is below a level that would cause displacement of harbour porpoises.

Enhanced ship traffic due to maintenance operations was regarded a relevant factor for the presence of harbour porpoises by some authors. Nabe-Nielsen et al. (2014) proposed that broadband sound source levels of ships would be at least 10-20 dB higher than those of operating wind turbines. Harbour porpoises were observed to avoid engine-driven boats (e.g., Polacheck & Thorpe 1990). Tougaard et al (2006) found lowest detection rates inside the windfarm not in the construction period, but during the semi-operational phase (when intensive maintenance took place) of the Danish OWF Horns Rev I. Results from that OWF indicated a weak negative effect of construction and semi-operation on porpoises, with more specific effects linked to pile driving activities and no effects were observed from the operating windfarm (Tougaard et al. 2006). Our results from alpha ventus were similar to those of Horns Rev I. Due to extensive repair works and maintenance of OWF alpha ventus, ship traffic was enhanced close to the windfarm in 2010 and to a lesser extent also in 2011. Ships were moving and conducting certain operations in the project area, and by this probably affected harbour porpoises. Hence, we suppose that increased ship traffic due to maintenance operations contributed to a considerable displacement of harbour porpoises around OWF alpha ventus in 2010 and 2011. During normal operation of the windfarm in 2012 porpoise activities reached higher levels again. The strong increase of detection rates in the 'Impact area' and 'Reference close' during operation was probably not prone to generally increasing densities of harbour porpoises in the southern North Sea during the last decades (e.g., Haelters & Camphuysen 2008; Gilles & Siebert 2009; Gilles et al. 2011; Haelters et al. 2011; Scheidat et al. 2011; IFAW 2012; Geelhoed et al. 2013; Hammond et al. 2013), since such a strong increase was not found at POD station clusters 'Reference distant' and 'Borkum Reef Ground'.

Offshore windfarms in operation principally bear a potential of positive long-term effects on harbour porpoises. In soft-bottom environments OWF turbine foundations produce new hard-substrate habitats for marine organisms, as the foundations are soon overgrown by a rich epifauna which also attracts fish (e.g. Krone et al. 2012, Simon 2012). At Belgium offshore windfarms, local species richness and biomass were shown to be greatly enhanced not only around single turbine foundations, but also on the scale of entire OWF areas (Rumes et al. 2013). The new hard-substrate habitats attracted certain fish and other species on a local scale (e.g., Coates et al. 2013; De Mesel et al. 2013; Reubens et al. 2013; Vandendriesche et al. 2013a), which might in turn attract harbour porpoises due to new food sources (as shown for re-established reefs in the Danish Kattegat by Mikkelsen et al. 2013), and affect their diel rhythm (Brandt et al. 2014). The reef effect might be enhanced by the fact that OWF areas are closed to commercial fisheries, the so-called 'refugium effect', which however seemed to be differently valid for different fish species and windfarms (Vandendriesche et al. 2013b). Since reef and refuge effect could have led to potentially increased food sources for harbour porpoises around and inside the windfarm, these effects might cause higher detection rates at POD stations in the proximity of alpha ventus ('Impact area', 'Reference close') in 2012. Indeed, the number and biomass of fish caught in 100-150 m distance to turbine foundations clearly increased from 2010 to 2012 (IfAÖ 2013). Due to the small size of the alpha ventus windfarm, both effects are expected to be small but may be relevant on a local scale.

Finally, it has to be considered that our alpha ventus dataset did not represent an undisturbed operational phase of an OWF, since maintenance of the turbines was quite extensive, especially in the first year (2010) after construction of alpha ventus. Furthermore, the construction of OWF Trianel Windpark Borkum, Phase I (BW2) in the project area between September 2011 and March 2012 could have affected the presence and migration patterns of harbour porpoises in the area. In this respect, slightly lower harbour porpoise detection rates at 'Borkum Reef Ground' in autumn 2011 and partly afterwards might somehow have been connected to the construction of BW2, but the effect was probably low, if even existent.

In summary, the observed patterns of harbour porpoise daily detection rates close to OWF alpha ventus during the first and second year of the Operation phase supposedly have been affected by enhanced ship traffic inside and around the windfarm area. The higher rates in the third year of Phase III might partly be attributable to reef effects due to the availability of new hard-substrate habitats which led to increased local fish biomass. The noise of wind turbines in operation was considered negligible regarding a negative effect on harbour porpoise detection rates at OWF alpha ventus.

4.4 Harbour seal and grey seal

4.4.1 Presence, phenology

Harbour seals and grey seals were monitored only by aerial and vessel-based surveys. About five times more harbour seals than grey seals were observed during these surveys, which reflected properly the proportion of grey seals to harbour seals within the entire Wadden Sea region (Trilateral Seal Expert Group 2013a; Fig. 4-1). Similarly to harbour porpoises, many more seals were

observed in the Western part of the project area, including parts of the Natura 2000 SCI Borkum Reef Ground. This protected area obviously was of major ecological importance not only for harbour porpoises, but also for both seal species common in the region. For this reason, both seal species together with harbour porpoises are listed as important conservation objectives of the SCI Borkum Reef Ground. However, since seals are difficult to observe and overall densities are low, the dataset was insufficient for drawing any conclusions on seal phenologies.

4.4.2 Effects of windfarm construction and operation

During a seasonally comparable spring/summer period with pile-driving activities in 2009 (15.5.-31.7.), individuals numbers of harbour seals per valid aerial survey transect km were lowest in that year, when compared to numbers from the same period in 2008 and 2010-2012. This gives some advice that also for harbour seals construction activities could lead to avoidance behaviour. But since animal density and temporal resolution of visual surveys were too low in order to determine any possible small-scale effects of pile-driving activities on presence or absence of seals at a robust statistical level, the StUK standard methods failed to give any answers on possible effects of the construction of windfarms on seals. Here, data at a much higher temporal and spatial resolution can be gained by satellite telemetry, which was successfully shown by Adelung & Müller (2008) and Tougaard et al. (2008).

As for harbour porpoises, also for harbour seals the numbers counted during the Baseline survey were exceeded by numbers of the Operation phase, reflecting an increasing population in the European Wadden Sea (Trilateral Seal Expert Group 2013a). Regarding grey seals, sighting rates were much too low to draw further conclusions for this species.

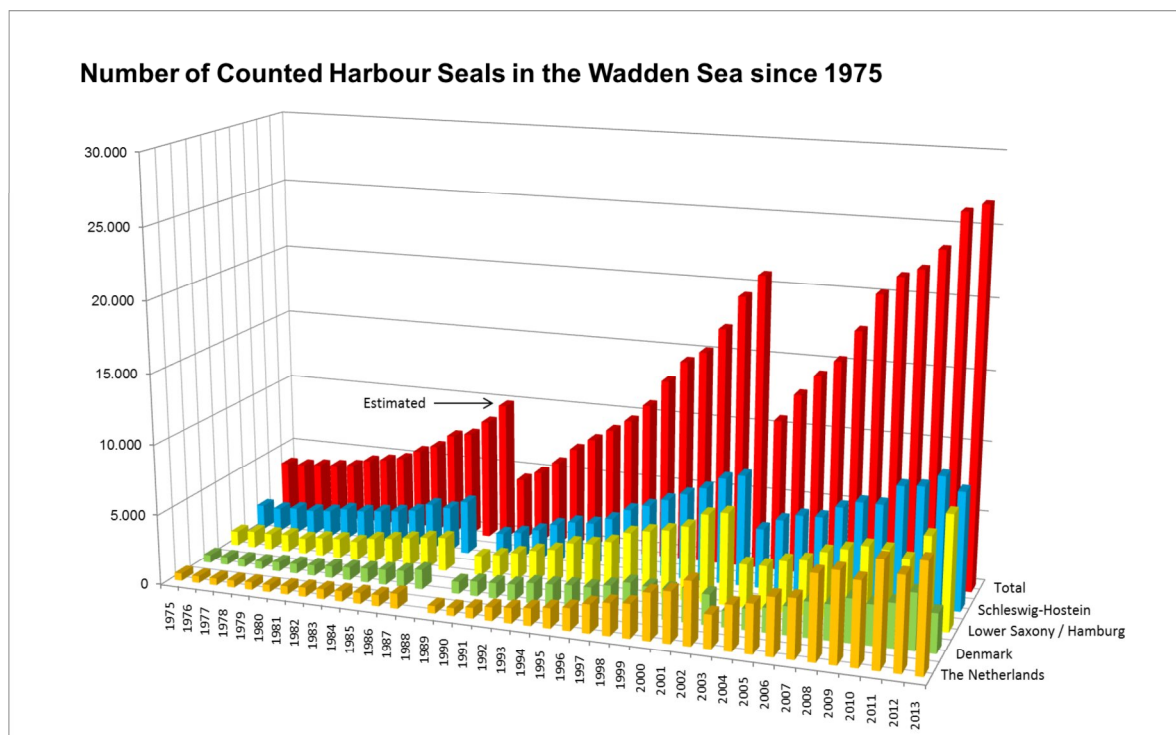

Fig. 4-1: Long-term development of harbour seals in the European Wadden Sea according to aerial surveys (source: Trilateral Seal Expert Group 2013a).

4.5 Evaluation of StUK3

Based on the results of this study, the Standards for Environmental Impact Assessments (StUK3) of the German Federal Maritime and Hydrographic Agency (BSH 2007) were only partly applicable and efficient regarding the evaluation of possible effects of the construction and operation of offshore windfarms on harbour porpoises. On the one hand, substantiated statements on effects of OWFs on these animals were possible when PAM data were analysed. On the other hand, the informative value of vessel-based surveys – and partly also of aerial surveys – in order to provide reliable data for analyses of windfarm effects on marine mammals was rather restricted. Data of such surveys were prone to be seriously affected by highly variable conditions, animal behaviour, and (for vessel-based surveys) by displacement effects. Regarding PAM, we were not able to strictly follow StUK3 since it was not possible to place PODs inside the windfarm area during Phase I and II of the project, and during Phase III only two instead of the demanded six PODs were deployed inside the OWF. Instead, more PODs were placed outside the OWF area. Three of these in the closest proximity of the OWF were considered as 'Impact Area'. Nine PODs in various distances were regarded as references (instead of the demanded three PODs); however, it turned out that around none of these PODs harbour porpoises remained truly unimpacted by the windfarm alpha ventus.

Certain statistical methods recommended in StUK3 were not up to date anymore, and we used more recent methods of model building (e.g., *GAMs*) that were also recommended by the new StUK4 (BSH 2013). Generally, developments in statistical methodology are rapid, and strict statistical demands might not be adequate over a period of several years.

A prominent feature of our study was the realisation of a baseline survey according to StUK3 before construction of OWF alpha ventus took place. Yet, due to logistic constraints, the baseline survey spanned less than the one-year period recommended by StUK3, which resulted in a shorter seasonal period available for comparisons of phenologies between the three project phases. Nevertheless, even with a shortened baseline survey statistically significant differences between harbour porpoise detection rates of the project phases were assessable.

Regarding the evaluation of any effect of the construction and operation of offshore windfarms on seals, the standard methods within the StUK were not sufficient to come up with a statistically robust data set. Here, only methods with a much higher effort like satellite telemetry would be sensitive enough to gain data in sufficient spatial and temporal resolution.

4.6 Synopsis and outlook

This 5-year study was the first based on a baseline, construction and three years operational survey when investigating the effects of the construction and operation of a German offshore windfarm on marine mammals. By means of a Baseline survey we were able to assess the effects of OWF alpha ventus on marine mammals more adequately.

We showed that pile driving during construction of OWF alpha ventus caused long-ranged, but short-termed displacement of harbour porpoise. Here, displacement of harbour porpoises was related to the noise level perceived. The study further demonstrated that such short-term displacement effects were also related to the duration of pile driving.

Apart from these clear short-term displacement effects of pile-driving, we could also show a reduction in porpoise presence and absolute abundance over two years after construction within the windfarm area and its close surrounding, likely to be caused by ship traffic for installation and maintenance of wind turbines.

Since effects of pile-driving for OWF alpha ventus were short-termed, and long-lasting effects of the windfarm were only short-ranged, we consider negative impacts of the construction, operation, and maintenance of the small OWF alpha ventus on harbour porpoises as being unlikely on the population level. In support of this, we found no pronounced shift in phenological cycles and regional distribution patterns of harbour porpoises.

Future interest will certainly be directed to cumulative effects on marine mammals by several OWFs during construction, operation, and maintenance. alpha ventus is a relatively small offshore windfarm with only 12 turbines, and its effects were not far-reaching. But not only Germany, also Denmark, the Netherlands, Belgium, and Great Britain have plans to build new OWFs in the North Sea during the next years, and most of these are much larger than alpha ventus. An interesting question would be whether the temporal and/or spatial range of potential long-lasting effects after windfarm construction would be related to the size of a windfarm. In this respect, it needs to be considered that all projects under construction are currently have to apply noise mitigation systems which markedly reduce temporary impacts of pile-driving. For example, with a big bubble curtain a noise mitigation of up to 12 dB was achieved at OWF Trianel Windpark Borkum, Phase I close to alpha ventus, corresponding to a reduction of the displacement radius to $\frac{1}{3}$ of its unmitigated range, and reducing the disturbed area around pile-driving locations by more than 90% (Diederichs et al. 2014). Even though noise levels of ongoing construction works with some projects still exceed the German norm (UBA 2011), a consequent application of noise mitigation systems already reduces the displacement of harbour porpoise to a level well below that with pile driving for alpha ventus.

Finally, studying potential effects of anthropogenic impacts on harbour porpoises inevitably leads to the question whether these effects would have consequences on the population level. Such were considered highly improbable with OWF alpha ventus, but a vast majority of offshore windfarms are larger than alpha ventus, and these might cause more far-reaching effects. In this respect, a promising approach regarding the assessment and quantification of the potential consequences for marine mammal populations of any displacement and/or injury that may result from offshore energy developments was developed by a panel convened by the National Research Council of the United States National Academy of Sciences (NRC) and published in a report on biologically significant effects of noise on marine mammal populations (NRC 2005: Fig. 4-2). The panel developed what they referred to as a 'conceptual model' that outlines the way marine mammals respond to anthropogenic sound, and how the population-level consequences of these responses could be inferred on the basis of observed changes in behaviour. This model was named 'Population Consequences of Acoustic Displacement' (PCAD). PCAD models should be used and further enhanced to ensure that no negative impacts of OWF construction, operation, and maintenance on marine mammals will take place on the population level. These models can provide critical values (for OWF size, pile-driving duration, noise level, etc.) above which negative consequences for marine mammals are possible on the population level, or specify the range of effects to be expected. By this, they will help to link noise protection norms to effects. The results of our study on effects of OWF alpha ventus on harbour porpoises will be an important mosaic

piece to be fed into PCAD models, in order to get a better estimation of population-level consequences of offshore windfarms in future.

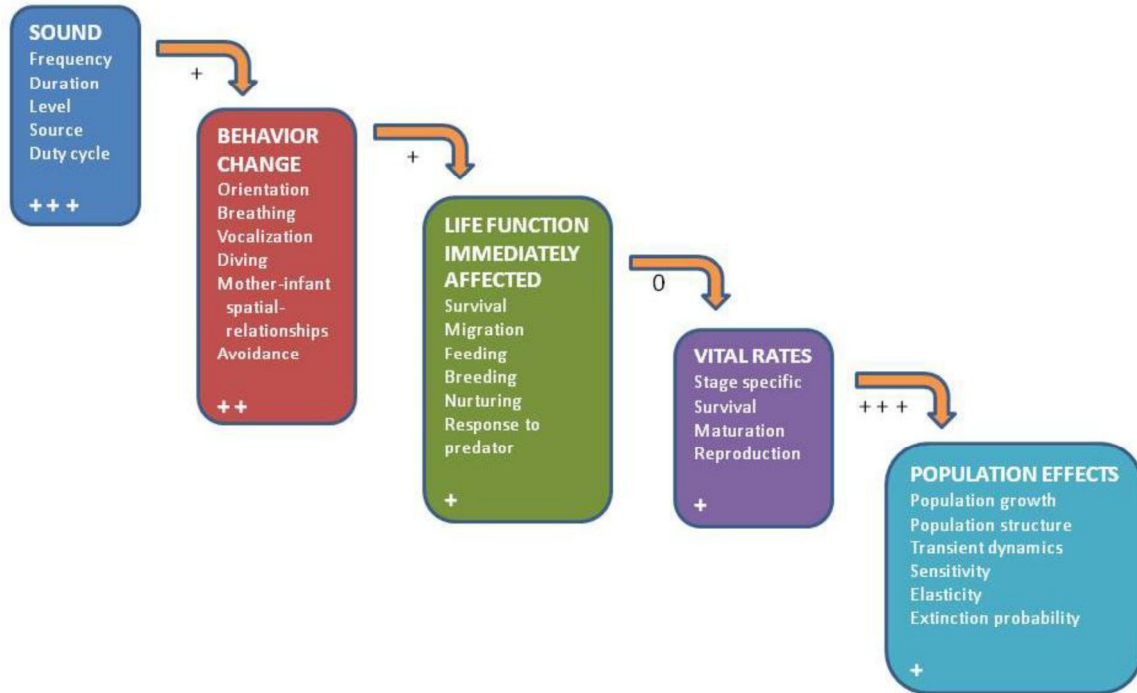

Fig. 4-2: The Population Consequences of Acoustic Displacement (PCAD) model developed by the National Research Council's panel on the biologically significant effects of noise. After Fig. 3.1 in NRC (2005). The number of + signs indicates the panel's evaluation of the relative level of scientific knowledge about the links between boxes, 0 indicates no knowledge. These links were described by the panel as "transfer functions".

5 SUMMARY

The first German offshore windfarm (OWF) alpha ventus was constructed between September 2008 and August 2009 in the German Bight north of Borkum, North Sea. It comprises twelve offshore wind turbines on an area of 4 km² and is officially operating since April 2010. Using OWF alpha ventus as a test site, a major goal of this study, being part of project alpha ventus on behalf of the Deutsche Offshore-Testfeld- und Infrastruktur GmbH & Co. KG (DOTI), was to investigate the effects of the construction and operation of offshore windfarms on marine mammals. The results provided a base for evaluating the Standards for Environmental Impact Assessments (StUK3) of the German Federal Maritime and Hydrographic Agency (BSH 2007) as to their appropriateness and efficiency. According to StUK3, the effects of the construction and operation of OWF alpha ventus on marine mammals were analysed by comparing data of the construction phase (Phase II: 2008/09) and operation phase (Phase III: 2010-2013) to those of the baseline survey (Phase I: 2008). StUK3 was only partly applicable and efficient. Whereas, PAM analyses allowed sound statements on possible effects of the construction and operation of offshore windfarms on harbour porpoises, data of vessel-based surveys (partly also aerial surveys) were less prone to do so, due to high variability. Because of these methodological flaws and due to low densities, the evaluation of effects of the construction and operation of offshore windfarms on seals was not feasible by StUK3. For the evaluation of such effects, a much higher effort like satellite telemetry would be needed in order to get data of sufficient spatial and temporal resolution.

Harbour porpoises were affected by the offshore windfarm test site alpha ventus. Most pronounced effects occurred along with pile-driving activities during the construction phase. In a close range of up to 4 km distance to pile driving, harbour porpoises were displaced for up to two days after pile driving. Taking into account all pile-drivings, a response of harbour porpoises started at 143 dB_{SEL50}. Since other studies found similar sound levels regarding a significant displacement of harbour porpoises due to pile-driving noise, nowadays profound evidence exists that escape reactions of these animals mostly start at sound exposure levels between 140 dB_{SEL50} and 145 dB_{SEL50}. Furthermore, we showed that the duration of pile-driving activities was of importance for the duration and range of displacement effects on harbour porpoises. Depending on the average pile-driving duration (1 h, or 5 h), significant displacement effects were detected at an average distance of 8.3 km, or 16.6 km from construction sites, respectively. According to sound propagation models, these distances would have corresponded to sound exposure levels of 143 dB_{SEL50} or 151 dB_{SEL50} respectively. Yet, whereas we consider that for a single strike it was mainly the noise level which determined the strength of a response, the increasing displacement radii of longer piling events were more likely to be caused by the fact that animals continuously moved further away from the sources as piling continued, making displacement effects apparent at lower noise levels. The respective increase of the radius of displacement from 8.3 km to 16.6 km would be equivalent to an up to 4-fold increase of the disturbed area (from 216 km² to 866 km²). Thus, for a better protection of harbour porpoises it would make sense to split long pile-driving periods into shorter phases of pile driving, with sufficient breaks inbetween. Temporary harming of animals was possible up to distances of 2 km from unmitigated pile driving, however, permanent injury was not very likely. We also found evidence for a negative impact of construction works on harbour seals, which were reduced in numbers during the Construction phase. A consequent operation of noise mitigation systems would help to reduce negative impacts of pile driving on marine mammals.

In a close range of up to 2 km around OWF alpha ventus, and only there, we registered lower harbour porpoise detection rates than measured during the baseline survey (2008) during a period of up to two years after construction works took place (i.e., operation phase until 2011). In the third year after construction even higher detection rates were recorded in close vicinity compared to the baseline. Whereas the moderate noise of offshore wind turbines in operation seemed to have had no effect on harbour porpoises, enhanced ship traffic for installation and maintenance of wind turbines was supposed to be a relevant factor for this finding. However, the causality complex was difficult to disentangle by our data, possibly also including positive long-term effects due to the availability of new hard-substrate habitats for marine organisms caused by the presence of wind turbine foundations.

Since effects of pile-driving for the small OWF alpha ventus were short-termed, and long-lasting effects of the windfarm were only short-ranged, we consider negative impacts of the construction, operation, and maintenance of OWF alpha ventus on harbour porpoises as being unlikely on the population level. In support of this, we found no pronounced shift in phenological cycles and regional distribution patterns of harbour porpoises.

A considerable number of offshore windfarms much larger than alpha ventus will be constructed in the North Sea during the next few years. Due to this, a substantial proportion of future research should be addressed to the evaluation of cumulative effects on marine mammals during simultaneous construction, maintenance, and operation of several OWFs. In this respect, the results of our study on effects of OWF alpha ventus on harbour porpoises will be an important mosaic piece to be fed into PCAD models, in order to get a better estimation of population-level consequences of offshore windfarms in future.

6 DEUTSCHE KURZFASSUNG

6.1 Einleitung und Methoden

Mit diesem Abschlussberichts des Fachgutachtens Meeressäuger des Projektes alpha ventus liegt erstmals eine 5-Jahres-Studie vor, in der das gesamte Standarduntersuchungskonzept des Bundesamtes für Schifffahrt und Hydrographie (BSH) zur Untersuchung der Auswirkungen von deutschen Offshore-Windparks auf die Meeresumwelt (StUK3: BSH 2007) – einschließlich einer Basisuntersuchung vor der Windpark-Errichtung – implementiert wurde.

Der erste deutsche Offshore-Windpark (OWP) alpha ventus wurde zwischen September 2008 und August 2009 auf einer Fläche von 4 km² in der Deutschen Bucht (Nordsee) 45 km nördlich der Insel Borkum gebaut. Die zwölf Windturbinen, von denen sechs auf Jacket- und weitere sechs auf Tripod-Fundamenten errichtet wurden, wurden offiziell im April 2010 in Betrieb genommen.

Von 2008 bis 2013 wurden ökologische Begleituntersuchungen an Meeressäugern gemäß StUK3 von BioConsult SH (Husum) sowie dem IfAÖ (Hamburg) im Auftrag der Deutsche Offshore-Testfeld- und Infrastruktur GmbH & Co. KG (DOTI) durchgeführt. Ziel der Untersuchungen war zum einen die Erfassung möglicher negativer Auswirkungen der Errichtung und des Betriebs von Offshore-Windparks auf Meeressäuger am Beispiel des Testfeldes alpha ventus, zum anderen eine Evaluierung der Effizienz und Anwendbarkeit des StUK3. Hierbei arbeitete die vorliegende Studie bereits mit neueren statistischen Methoden der Modellbildung, welche auch im aktuellen StUK4 (BSH 2013) empfohlen werden.

Gemäß StUK3 wurde die vorliegende Studie in drei Phasen unterteilt: 1) Eine Basisuntersuchung vor der Errichtung des Windparks (Phase I: März bis Juli 2008); 2) Untersuchungen während der Konstruktionsphase (Phase II: August 2008 bis Dezember 2009); 3) Untersuchungen während der Betriebsphase, der ersten Jahre des laufenden Betriebs des Windparks (Phase III: Dezember 2009 bis Mai 2013).

Drei Meeressäugerarten traten regelmäßig im Untersuchungsgebiet auf: Schweinswal (*Phocoena phocoena*), Seehund (*Phoca vitulina*) und Kegelrobbe (*Halichoerus grypus*). Von diesen ist der Schweinswal in der Roten Liste gefährdeter Tiere, Pflanzen und Pilze Deutschlands (Haupt et al. 2009) als stark gefährdet (Status 2), Seehund und Kegelrobbe als gefährdet (Status 3) eingestuft. Alle drei Arten sind von gemeinschaftlichem Interesse und u.a. im Annex II (als nicht prioritäre Arten, für die Natura 2000-Gebiete auszuweisen sind) sowie Annex IV der FFH-Richtlinie der EU (European Council 1992) gelistet, wobei für diese Arten ein strenges Schutzsystem nach Artikel 12 ff. einzurichten ist. Der Erhaltungszustand für den Schweinswal in der Atlantischen Biogeographischen Region (Nordsee) wird im neuesten FFH-Bericht der Bundesregierung mit „ungünstig- unzureichend“ eingeschätzt (zitiert nach BMU 2013).

Die Meeressäuger wurden mittels dreier Methoden erfasst. Alle drei Arten wurden visuell über Flugzeug- sowie Schiffstransektzählungen registriert, was vor allem der großräumigen Bestandsaufnahme zu bestimmten Zeitpunkten diente. Zudem wurden Schweinswalaktivitäten kontinuierlich mittels Methoden des Passiven Akustischen Monitorings (PAM) an räumlich eng begrenzten

Stationen überwacht. Vor allem die Kombination von PAM und Flugzeugzählungen lieferte ein umfassendes Bild der räumlich-zeitlichen Verteilungsmuster der Schweinswale im Projektgebiet.

Innerhalb des PAM fand im April 2010 ein Methodenwechsel der Schweinswaldetektoren (PODs) von T-PODs zu C-PODs statt, was die Entwicklung eines Modells zur Umrechnung von T-POD-Daten in C-POD-Äquivalente erforderte. Dies wurde durch das gleichzeitige Ausbringen beider POD-Typen an bestimmten Stationen ermöglicht, womit alle weiteren möglichen Einflussfaktoren konstant gehalten werden konnten.

Insgesamt waren im Projektverlauf jeweils 12 POD-Stationen besetzt (Fig. 6-1; s. Tab. 2-6). Jedoch mussten deren Positionen aufgrund logistischer Notwendigkeiten teilweise verschoben werden.

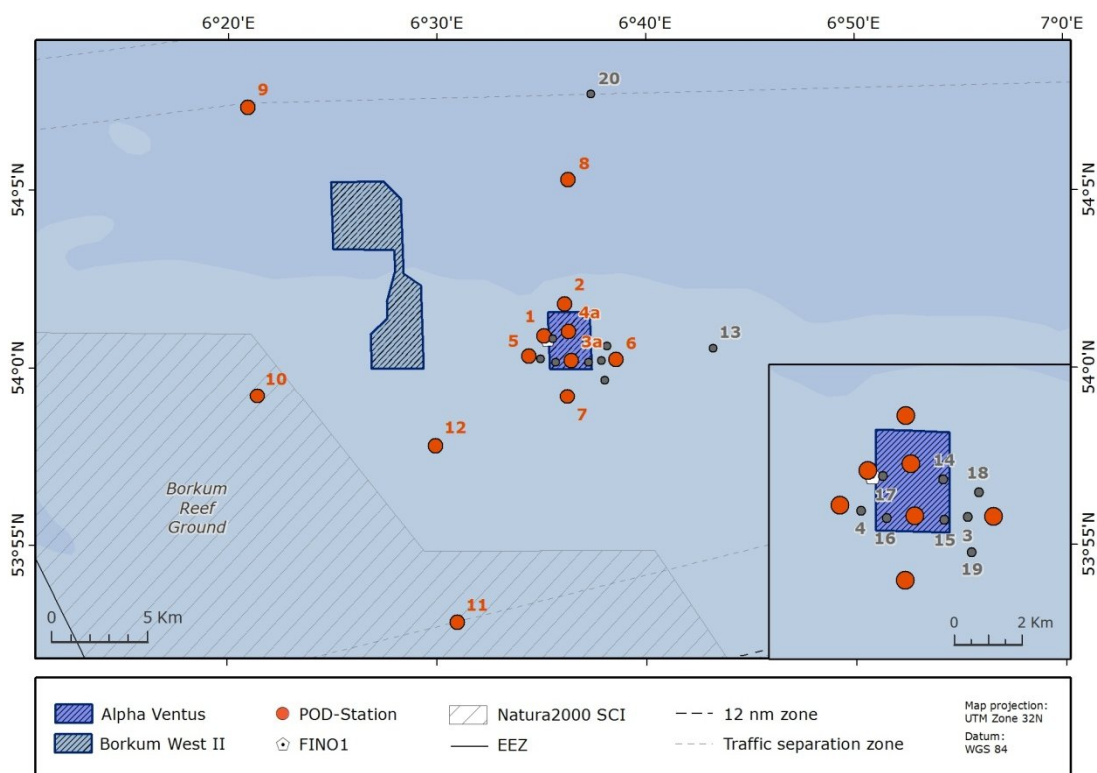

Fig. 6-1: Position des OWP alpha ventus (blau) und Trianel Windpark Borkum, Phase I (graugrün), sowie POD-Positionen in den Untersuchungsjahren 2008-2013 (graue Kreise: alte Positionen; rote Kreise: Positionen am Projektende; teils gab es aus logistischen Gründen Positionsverschiebungen).

6.2 Ergebnisse

An allen POD-Stationen wurden nahezu täglich Schweinswalsignale aufgezeichnet (Rate schweinswalpositiver Stationstage: 96,8%), wobei sich das Projektgebiet als uneinheitlich hinsichtlich des räumlichen Auftretens dieser Tiere erwies. An den südwestlichen Stationen, die zum Stationscluster ‚Borkum Reef Ground‘ zusammengefasst waren (im Natura 2000-Schutzgebiet Borkum Riffgrund), wurden im Durchschnitt gut doppelt so viele Schweinswalsignale aufgezeichnet wie an den drei nordöstlich davon gelegenen Stationsclustern ‚Impact Area‘, ‚Reference close‘ und ‚Reference distant‘.

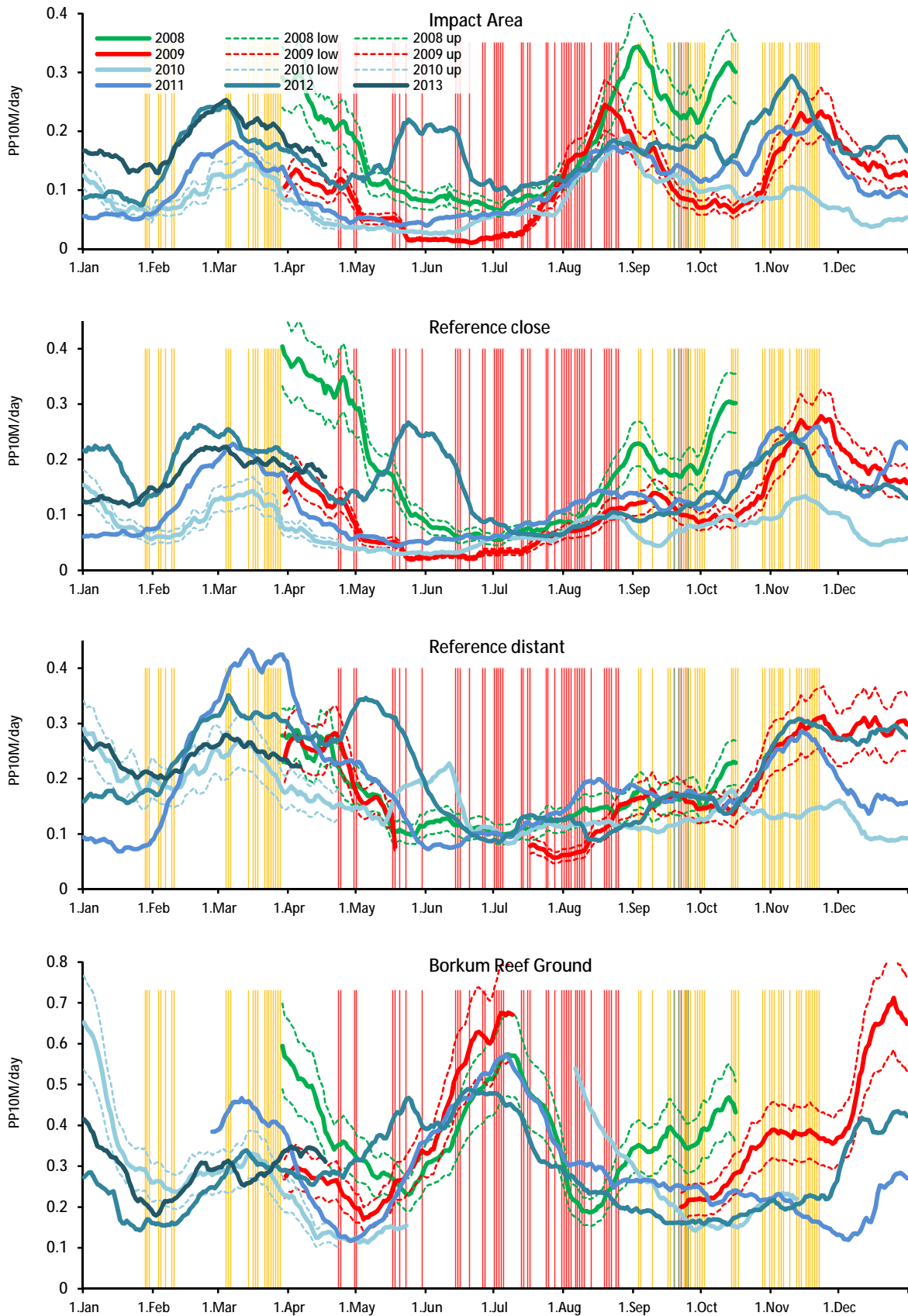

Fig. 6-2: *Tägliche Schweinswal-Detektionsraten (PP10M/day) im Verlauf der einzelnen Untersuchungs-jahre an vier POD-Stationsclustern; Kurven: 30-Tage 'moving averages' mit Konfidenzintervallen für konvertierte T-POD-Daten; senkrechte Linien: Rammungen (grün: alpha ventus 2008; rot: alpha ventus 2009; gelb: Trianel Windpark Borkum, Phase I: Sept 2011 bis März 2012).*

Die Berechnung täglicher Schweinswal-Detektionsraten *PP10M/day* aus den POD-Daten diente der Ermittlung phänologischer Muster und Langzeittrends. Insgesamt waren die phänologischen Muster für die jeweiligen Stationscluster über die Jahre hinweg relativ stabil, wobei es in einzelnen Jahren zu abweichenden Verläufen kommen konnte (Fig. 6-2).

Das jahreszeitliche Auftreten der Tiere bei Borkum Riffgrund unterschied sich aufgrund des dort ausgeprägten Frühsommer-Peaks deutlich von dem der anderen drei Stationscluster, wo in diesem Zeitraum zumeist (außer 2012) die niedrigsten Aktivitätsraten ermittelt wurden.

Ein klarer negativer Effekt der Rammarbeiten für OWP Trianel Windpark Borkum, Phase I auf die *PP10M/day*-Raten war anhand der Phänologiekurven nicht erkennbar. Allenfalls im Stationscluster ‚Borkum Reef Ground‘ lagen die Raten im Herbst 2011 und 2012 niedriger als in 2009.

Während eines phänologisch vergleichbaren Zeitraums, welcher im Jahr 2009 Rammarbeiten einschloss (15.5.-31.7.), wurden für die dem Windpark-Areal am nächsten liegenden Stationscluster ‚Impact Area‘ und ‚Reference close‘ (nächste Turbine max. 2 km entfernt) von 2009 bis 2011 zwar leicht ansteigende, aber signifikant niedrigere *PP10M/day*-Raten als während der Basisuntersuchung 2008 festgestellt. Ein solches Muster war bei den entfernteren Stationsclustern ‚Reference distant‘ und ‚Borkum Reef Ground‘ nicht erkennbar. Im Jahr 2012 wurden bei allen Clustern höhere Detektionsraten als während der Basisuntersuchung ermittelt, wobei der Unterschied bei ‚Borkum Reef Ground‘ am geringsten ausfiel (Fig. 6-3).

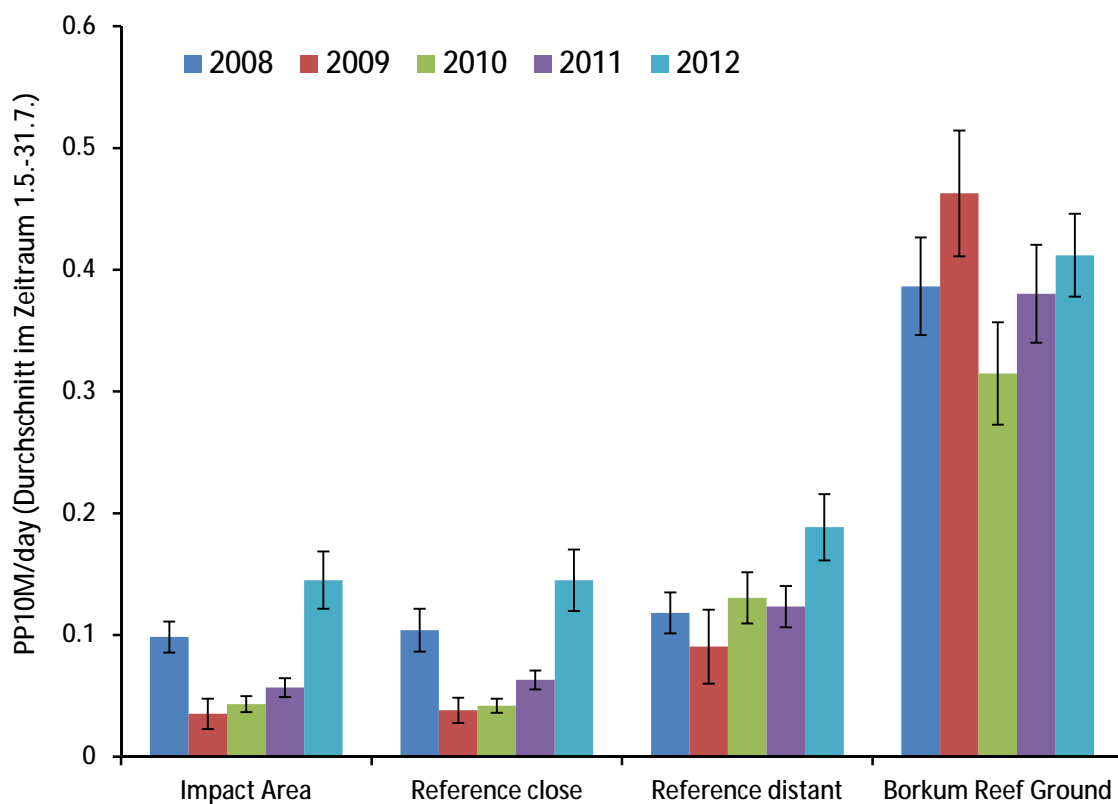

Fig. 6-3: Mittlere *PP10M/day*-Detektionsraten, unterteilt nach Projektjahren in vier POD-Stationsclustern, während eines jahreszeitlich vergleichbaren Zeitraums, welcher in 2009 Rammarbeiten einschloss (15.5.-31.7.); senkrechte Linien: 95%-Konfidenzintervalle.

Tab. 6-1: Anfangs- (15.12.2009) und Endwerte (21.04.2013) der über Zeitreihenanalysen für die Betriebsphase (Phase III) ermittelten Langzeittrends der täglichen Schweinswal-Detektionsraten (PP10M/day; Trend: prozentuale Änderung im angegebenen Zeitraum).

Stationscluster	PP10M/day Anfang	PP10M/day Ende	Differenz	Trend
Impact Area	0,0896	0,1915	+0,1019	+114%
Reference close	0,0781	0,1595	+0,0814	+104%
Reference distant	0,1756	0,2107	+0,0351	+20%
Borkum Reef Ground	0,3375	0,2865	-0,0510	-15%

Mittels Zeitreihenanalysen wurden Langzeittrends bei den täglichen Schweinswal-Detektionsraten (PP10M/day) in den einzelnen Stationsclustern über die gesamte Betriebsphase des Windparks (Phase III) hinweg ermittelt. Bei den Stationsclustern nahe des Windparks alpha ventus ('Impact area' und 'Reference close') verdoppelten sich die Werte in der Zeit von Dezember 2009 bis April 2013 (Spalte 'Trend' in Tab. 6-1), während sie im Cluster 'Reference distant' nur um 20% anstiegen. Bei 'Borkum Reef Ground' ergab sich ein umgekehrter Trend mit um 15% abnehmenden Raten im Verlauf der Phase III.

Mittels BACIP-Analysen (Before-After-Control-Impact-Analysen für paarweise Daten) der PP10M/day-Raten wurden Frühjahrs-/Sommer-Detektionsraten aus der Konstruktions- bzw. Betriebsphase (= After) denen von gleichen Kalendertagen der Basisuntersuchung (= Before) gegenübergestellt. Der BACIP-Effekt wurde über Datenunterschiede der Stationscluster 'Impact Area' (= Impact) und 'Borkum Reef Ground' (= Control) an diesen Tagen berechnet (Tab. 6-2).

Tab. 6-2: BACIP-Effekte ausgewählter Projektphasen-Vergleiche (Phase I [Before] vs Phase II/Phase III [After]), basierend auf prozentualen PP10M/day-Raten der Stationscluster 'Borkum Reef Ground' (Control) und 'Impact Area' (Impact); angegeben sind arithmetisches Mittel, Median, die erste (Q25) und dritte Quartile (Q75) sowie die Signifikanz des Unterschieds (** = hochsignifikant ($p \leq 0,01$); * = signifikant ($p \leq 0,05$); ns = nicht signifikant).

Phasen (B vs A)	Jahre (B vs A)	Signifikanzniveau	BACIP-Effekt in %PP10M/day			
			Arithm. Mittel	Q25	Median	Q75
I vs II	2008 vs 2009 **		-12,5	-31,7	-10,6	+3,2
I vs III/1	2008 vs 2010 **		-14,6	-35,1	-9,6	+4,9
I vs III/2	2008 vs 2011 *		-5,6	-16,0	-4,4	+5,5
I vs III/3	2008 vs 2012 ns		+1,1	-15,7	-1,6	+12,2

Der Unterschied zwischen Control und Impact war hochsignifikant bei einem Vergleich zwischen Daten der Basisuntersuchung 2008 und der Konstruktionsphase 2009 (Tab. 6-2). Der negative BACIP-Effekt betrug im Mittel mehr als 10% der PP10M/day-Raten, was in diesem Fall bedeutete, dass die täglichen Schweinswal-Detektionsraten des Jahres 2009 in der 'Impact Area' – bereinigt nach Kontrolldaten von 'Borkum Reef Ground' – um mehr als 10% unter den Raten eines vergleichbaren saisonalen Zeitraums des Vorjahres lagen. Gleiches galt für den Vergleich zwischen 2008 und dem ersten Jahr der Betriebsphase (2010). Noch signifikant war auch der Unterschied zwischen 2008 und 2011, wenn auch der negative BACIP-Effekt nur noch etwa 5% betrug. Kein

signifikanter Effekt konnte hingegen beim Vergleich der Basisuntersuchung 2008 mit dem dritten Jahr der Betriebsphase (2012) festgestellt werden.

Insgesamt konnte mittels passiven akustischen Monitorings (PAM) im Nahbereich bis zu 2 km um den Windpark alpha ventus herum übereinstimmend sowohl bei Phänologievergleichen als auch bei Zeitreihen- und BACIP-Analysen ein Wiedererreichen der täglichen Schweinswal-Detektionsraten *PP10M/day* der Basisuntersuchung (2008) erst im dritten Jahr der Windpark-Betriebsphase (2012) festgestellt werden.

Bezüglich der Konstruktionsphase (Phase II) erfolgte die genaue Ermittlung eines räumlich-zeitlichen Effekts der Rammarbeiten für alpha ventus auf das Auftreten von Schweinswalen mittels stündlicher Detektionsraten *PPM/h*. Es wurde über Generalisierte Additive Modelle (*GAM*) berechnet, ob es signifikante Effekte der Rammungen gab, bis in welche Entfernung zu Rammarbeiten Vertreibungseffekte feststellbar waren und wie viele Stunden lang eine Vertreibung anhielt. Bei Berücksichtigung aller Rammarbeiten – unabhängig von der Dauer der Rammphasen – wurden signifikante Schweinswal-Vertreibungseffekte der Rammungen bis in 10 km Distanz zu den Baustellen ermittelt.

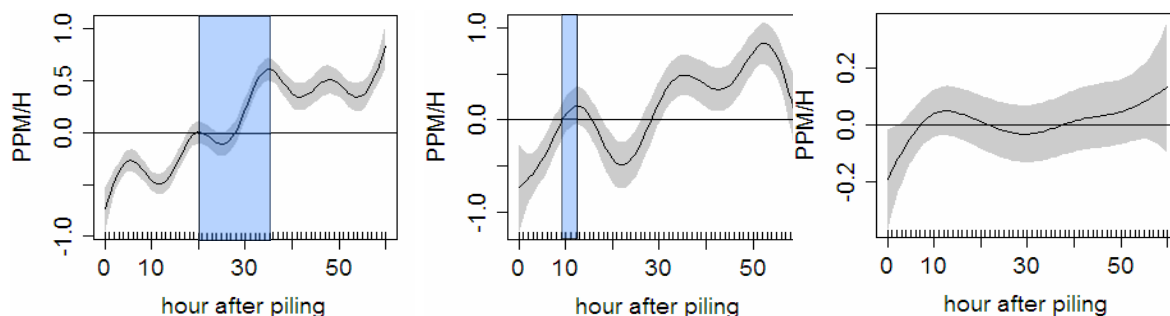

Fig. 6-4: *GAM plots von Rammeeffekten auf PPM/h-Detektionsraten von Schweinswalen bei Berücksichtigung aller Rammungen (von links nach rechts: Distanzklassen 1, 2, 3); blau: minimale bis maximale Dauer eines Vertreibungseffekts.*

Wurde hingegen nach Rammdauer unterschieden (stellvertretend hierfür stand bei alpha ventus der Fundamenttyp: Tripod: lange Rammphasen von durchschnittlich 5 h; Jacket: kurze Rammphasen von durchschnittlich 1 h), ergaben sich bei den Tripod-Fundamenten gravierendere Auswirkungen der Rammarbeiten auf die Schweinswal-Detektionsraten als beim Gesamtdatensatz.

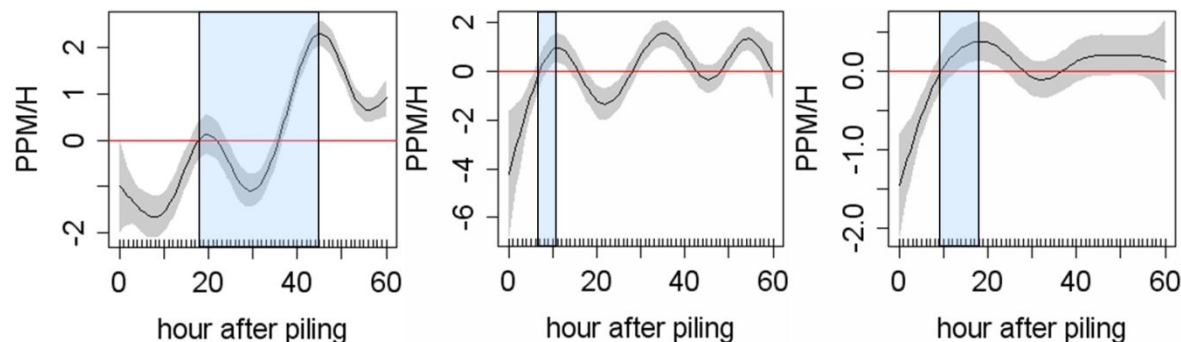

Fig. 6-5: *GAM plots von Rammeeffekten auf PPM/h-Detektionsraten von Schweinswalen bei Berücksichtigung von Rammungen für Tripod-Fundamente (von links nach rechts: Distanzklassen 1, 2, 3); blau: minimale bis maximale Dauer eines Vertreibungseffekts.*

Tab. 6-3: *Effektdauer bei verschiedenen Fundamenttypen mit unterschiedlicher Durchschnittsdauer der Pile-driving events (Tripod: 5 h; Jacket: 1 h) sowie bei Berücksichtigung der Daten aller Rammungen auf stündliche Schweinswal-Detektionsraten PPM/h.*

Distanzklasse (Entf.)	Tripod Effektdauer	Jacket Effektdauer	Alle Rammungen Effektdauer
1 (< 4 km: ø 2,4 km)	18-45 h	20-35 h	18-34 h
2 (4-10,2 km: ø 8,3-9,1 km)	6-11 h	9-13 h	6-12 h
3 (> 10,2 km: ø 16,6 km)	6-18 h	-	-

Nur bei den längeren Tripod-Rammarbeiten ergaben sich signifikante Effekte in der Distanzklasse 3 (Median: 16,6 km Distanz zu Rammarbeiten). Im Nahbereich hielt der Effekt mindestens 18 h lang an. Die maximale Effektdauer bei Tripod-Rammungen betrug etwa 10 h mehr als bei Rammungen für Jacket-Fundamente sowie beim Gesamtdatensatz (Tab. 6-3).

Auch die Gesamtdauer signifikant verlängerter Wartezeiten während und nach realen Rammungen in 2009 (im Vergleich zu hypothetischen Rammungen in 2008) war bei Tripod-Fundamenten deutlich erhöht (Tab. 6-4). Und nur bei den kurzen Rammungen der Jacket-Fundamente wurde kein signifikanter Effekt in Distanzklasse 3 festgestellt.

Tab. 6-4: *Durchschnittliche Gesamtdauer (Median) aufeinanderfolgender Wartezeiten mit signifikanten Unterschieden zwischen hypothetischen Rammungen in 2008 und realen Rammungen in 2009 (unterteilt nach Fundamenttyp; Durchschnitts-Rammdauer Tripod: 5 h; Jacket: 1 h); Effekt nach Rammung: Effekt mit geschnittener 1. Wartezeit anstelle der gesamten 1. Wartezeit; *) nur eine Station (T12).*

	Distanzklasse	Tripod		Jacket		Alle Rammungen	
		Effekt inkl. Rammung	Effekt nach Rammung	Effekt inkl. Rammung	Effekt nach Rammung	Effekt inkl. Rammung	Effekt nach Rammung
Median	1 (< 4 km)	49,2 h	16,5 h	15,5 h	3,1 h	19,7 h	9,0 h
	2 (4-10,2 km)	0 h *)	0 h *)	14,1 h	9,0 h	16,1 h	5,9 h
	3 (> 10,2 km)	8,6 h	0 h	0 h	0 h	4,0 h	0 h

Die über Modelle und Wartezeiten ermittelten Distanzen signifikanter Effekte von Rammungen auf Schweinswale wurden gemäß der von der itap GmbH entwickelten Schallausbreitungformel (Diederichs et al. 2014) in Schallpegel umgerechnet (Tab. 6-5). Für den Gesamtdatensatz aller Rammungen war ein signifikanter Vertreibungseffekt ab einem mittleren SEL (sound exposure level) von 143 dB_{SEL50} re 1 µPa feststellbar, dies allerdings nur mittels Wartezeiten. Über GAMS wurde ein solcher Effekt erst bei durchschnittlich 150 dB_{SEL50} re 1 µPa ermittelt. Für alle Rammungen lag die Spanne über beide Berechnungsmethoden bei 142-152 dB_{SEL50} re 1 µPa.

Die Dauer der Rammarbeiten war für das räumliche Ausmaß der Vertreibungseffekte von Bedeutung. Diese reichten hinsichtlich der längeren *Pile-driving events* für die Tripod-Fundamente (im Mittel 5 h lang) bis in 16,6 km Entfernung von den Rammorten (Spanne: 14,2-22,6 km), hingegen bei Jacket-Rammungen (im Mittel 1 h lang) bis in 8,4-9,1 km Entfernung von den Rammorten (Spanne: 7,5-10,1 km). Folglich lag der zusätzlich durch eine um 4 h längere Rammdauer verursachte räumliche Vertreibungseffekt beim OWP alpha ventus in der Größenordnung von 8-9 km.

Tab. 6-5: Distanzen zu Rammungen (Median, Minimum, Maximum) sowie umgerechnete Schallpegel ($dB_{SEL,50}$ re $1 \mu Pa$) erster signifikanter aversiver Reaktionen von Schweinswalen; Unterteilung nach Fundamenttypen für OWP alpha ventus (mit entsprechender durchschnittlicher Dauer der Pile-driving events); DistKI: Distanzklasse (nur für Detektionsraten).

	Rammungen	DistKI/ Station	Dist [m] Min.	Dist [m] Median	Dist [m] Max.	dB_{SEL} , D min	dB_{SEL} , D median	dB_{SEL} , D max
Detek- tionsraten PPM/h	Alle	2	7.459	8.974	10.125	152	150	148
	Lang (Tripod: 5h)	3	14.209	16.558	22.566	144	143	138
	Kurz (Jacket: 1h)	2	7.487	8.366	10.125	152	151	148
Warte- zeiten	Alle	T10	15.647	16.653	17.560	143	143	142
	Lang (Tripod: 5h)	T10	15.647	16.653	17.560	143	143	142
	Kurz (Jacket: 1h)	T8	7.487	9.065	9.975	152	150	148

Die Schweinswaldichten im Untersuchungsgebiet wurden aus den gemittelten Daten von Flugtransekt-Zählungen für Vögel (76 m Flughöhe) und marine Säuger (183 m Flughöhe) über die Distance-sampling-Methode errechnet (Buckland et al. 2001).

Auffällig sind niedrigere Dichten im westlichen Teil des Untersuchungsgebietes von Mai bis August 2009, also während des Zeitraums, in dem hauptsächlich Rammungen für alpha ventus stattfanden (Fig. 6-6, oben rechts). Ähnliches gilt für den Zeitraum von September bis November 2009 (Fig. 6-6, unten links), also die Monate, welche den Rammarbeiten folgten. Von Februar bis April 2009 (Fig. 6-6, oben links) wurden hingegen keine niedrigeren Dichten festgestellt; alle Flüge dieses Zeitraums fanden vor den Rammarbeiten in 2009 statt. Die insgesamt niedrigere Schweinswalpräsenz im Untersuchungsgebiet während der Konstruktionsphase (Phase II) wurde auch durch die Daten der Schiffstransektzählungen bestätigt (Fig. 6-6, unten rechts).

Auch bei den Seehunden wurde mittels Flugtransekt-Zählungen eine deutlich geringere Präsenz im Untersuchungsgebiet während der Konstruktionsphase festgestellt. Während der Operationsphase wurden (standardisiert) zwei- bis dreimal so viele Tiere gezählt wie bei der Basisuntersuchung und sogar etwa zehnmal so viele wie während der Bauphase des Windparks.

Da bei den Flugtransekt-Zählungen auch in den drei Monaten nach den Rammungen 2009 die Schweinswaldichten im westlichen Teil des Untersuchungsraumes herabgesetzt waren, könnten Rammarbeiten und Turbineninstallation in 2009 weiter reichende Auswirkungen auf die Schweinswalpräsenz im Gebiet gehabt haben, als dies allein durch kurzfristige Rammereffekte, wie über Modelle und Wartezeiten aufgezeigt, erklärt werden konnte.

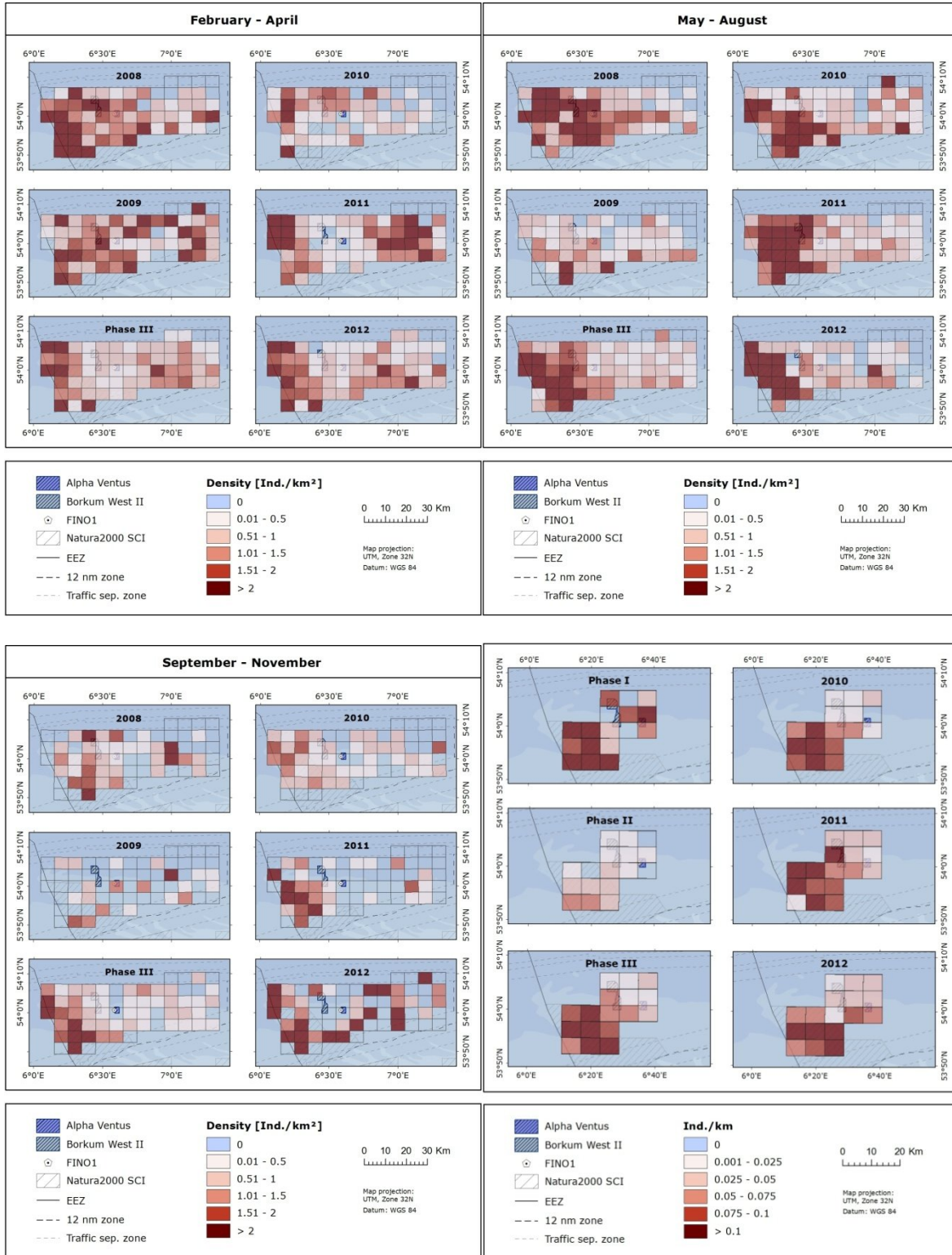

Fig. 6-6: Saisonale Rasterkarten der Schweinswaldichten (Ind./km²) aus Flugtransekten (unten links und oben) sowie der Individuen pro gültigem Transekt-km aus Schiffstransekten (unten rechts); Daten unterteilt nach Projektphasen (jeweils linke drei Plots), Phase III weiter unterteilt nach Jahren (jeweils rechte drei Plots).

Hinsichtlich der Auswirkungen der Operationsphase des OWP alpha ventus auf Schweinswale konnte auch unter Volllast kein negativer Effekt der Turbinen auf deren tägliche Detektionsraten *PP10M/day* im Nahbereich um den Windpark herum (POD-Stationscluster ‚Impact Area‘) ermittelt werden. Offenbar war die mit der Operation der Turbinen verbundene Lärmbelastung nicht hoch genug, um eine Scheuchwirkung auf Schweinswale auszuüben.

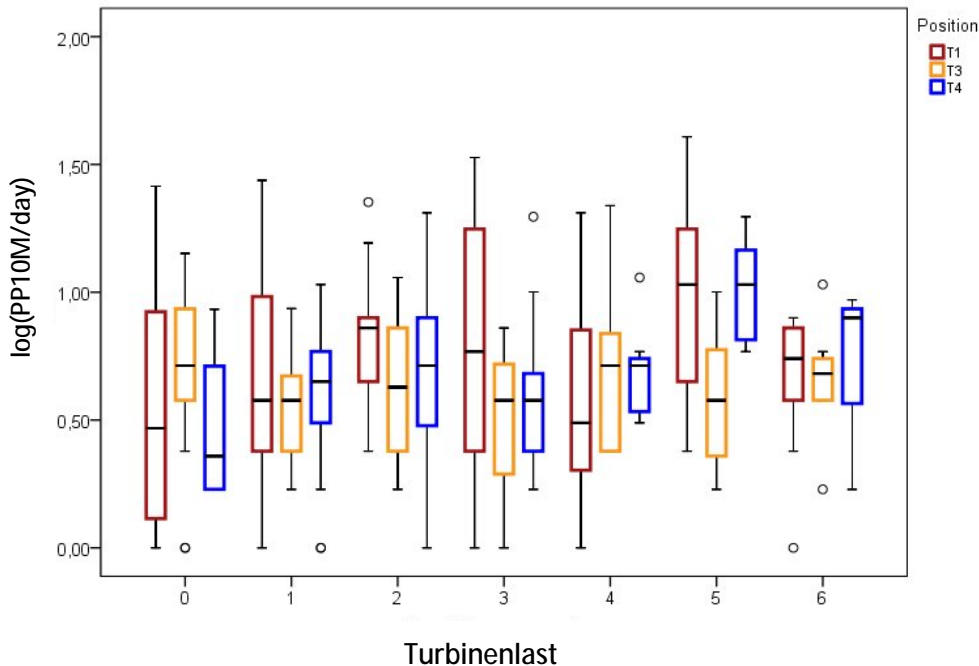

Fig. 6-7: Schweinswal-Detektionsraten *PP10M/day* im Nahbereich des Windparks alpha ventus (POD-Stationscluster ‚Impact Area‘) bei unterschiedlicher Turbinenlast (Volllast = 6).

6.3 Zusammenfassende Diskussion

Im Rahmen der vorliegenden 5-Jahres-Studie gemäß StUK3 (BSH 2007) zur Evaluierung der Auswirkungen des Baus und Betriebs von deutschen Offshore-Windparks auf Meeressäuger konnte erstmals für einen solchen Windpark eine Basisuntersuchung vor dessen Errichtung durchgeführt und berücksichtigt werden. Insgesamt erwies sich das StUK3 als nur teilweise geeignetes Instrumentarium, um die Auswirkungen von Offshore-Windparks auf Meeressäuger zu untersuchen. Zwar ließen die mittels eines Passiven Akustischen Monitorings (PAM) erhobenen Daten statistisch belastbare Aussagen hinsichtlich der Auswirkungen des Baus und Betriebs von Windparks auf Schweinswale zu. Jedoch konnten aus sicherheitstechnischen Gründen nicht von Beginn an, wie in StUK3 vorgesehen, PODs innerhalb des OWP alpha ventus positioniert werden. Zudem waren in puncto Robben die dort empfohlenen Transekt-Methoden aufgrund der hohen Variabilität der Daten und der geringen Dichten der Tiere im Gebiet nicht ausreichend. Hier wäre die Satelliten-Telemetrie in Zukunft ein brauchbareres Mittel, um Auswirkungen auf Robben in ausreichender räumlicher und zeitlicher Auflösung zu untersuchen.

Bei den verwendeten Erfassungsmethoden ergänzten sich hinsichtlich der Schweinswal-erfassungen Passives Akustisches Monitoring und Flugtransekte sinnvoll. Während PAM-Daten ein kontinuierliches Bild der Schweinswalaktivitäten an bestimmten, räumlich eng begrenzten Statio-

nen lieferten, waren die als Snapshot-Studien anzusehenden Flugtransekt-Erfassungen geeignet, diese Muster in einen größeren regionalen Kontext zu stellen und Dichten zu berechnen. Schiffstransekte lieferten bestenfalls ergänzende Daten zur Präsenz von Schweinswalen und anderen Meeressäugern, denn deren Daten waren stärker mit Unsicherheiten behaftet als jene der Flugtransekte und lieferten daher bei Meeressäuger-Erhebungen den geringsten zusätzlichen Nutzen der drei Methoden. Da Robben nur mit Schiffs- und Flugtransekten erfassbar waren, ließen sich für diese beiden Arten nur wenig belastbare Aussagen treffen.

Auch wenn die Rammarbeiten zur Errichtung des OWP alpha ventus in einen Zeitraum mit relativ geringen Schweinswalddichten fielen, was negative Auswirkungen auf natürliche Weise abschwächte, hatten die Bauarbeiten dennoch erheblichen Einfluss auf die Meeressäuger-Präsenz im Untersuchungsgebiet. Innerhalb eines Radius von 4 km um Baustellen herum waren Vertreibungseffekte der Rammarbeiten auf Schweinswale feststellbar, welche bis zu zwei Tage lang anhielten. Erste aversive Reaktionen der Tiere wurden über Wartezeiten zwischen Schweinswal-signalen ermittelt und traten ab einem Schallpegel von 143 dB_{SEL50} auf. Dieses Ergebnis stand in Übereinstimmung mit denen anderer Studien (z.B. Lucke et al. 2009; Brandt et al. 2009a, 2011, 2012; Haelters et al. 2012, 2013; Diederichs et al. 2014). Insgesamt deuten die meisten Studien darauf hin, dass in der Nordsee Vertreibungseffekte auf Schweinswale durch Rammschall bei Schallpegeln von 140-145 dB_{SEL50} beginnen. Jedoch konnten wir zeigen, dass in diesem Zusammenhang zusätzlich die Dauer der Rammarbeiten von Bedeutung ist. Bei den im Durchschnitt fünf Stunden lang andauernden Rammungen der Tripod-Fundamente für alpha ventus reichte ein Effekt im Mittel bis in 16,6 km Entfernung von den Baustellen, während ein solcher bei den durchschnittlich nur einstündigen Rammungen der Jacket-Fundamente nur bis in etwa 8,3 km Entfernung feststellbar war. Dies entspräche einer bis zu vierfachen Zunahme der Fläche signifikanter Vertreibungseffekte von 216 km² auf 866 km² bei langanhaltenden Rammarbeiten. Im Sinne eines besseren Schutzes von Schweinswalen vor Lärmbelastungen durch Rammarbeiten sollten geplante längere Rammperioden daher in kürzere Rammabschnitte mit ausreichenden Pausen dazwischen unterteilt werden. Zudem sollten konsequent Schallschutzsysteme nach neuestem technischem Stand eingesetzt werden. So können z.B. Blasenschleier den Rammschall um 10 dB_{SEL50} reduzieren, was Effektradien auf $\frac{1}{3}$ verringern und somit gestörte Flächen um über 90% reduzieren kann (Diederichs et al. 2014).

Kumulative Effekte von Rammarbeiten könnten auch auf größeren räumlichen Skalen als der einzelner Windturbinen oder Windparks relevant sein. Nicht nur Deutschland, sondern auch Dänemark, Holland, Belgien und Großbritannien haben zahlreiche weitere Bauvorhaben für Windparks in der Nordsee initiiert, welche innerhalb der nächsten Jahre realisiert werden sollen. Dies könnte dazu führen, dass Schweinswale und andere Meeressäuger zwischen verschiedenen Windpark-Arealen hin- und hergetrieben werden. Bei Schweinswalen handelt es sich um kleine, warmblütige Tiere in relativ kalten Gewässern, welche durch ihre Eigenschaften und Umweltbedingungen gezwungen sind, die meiste Zeit des Tages Nahrung aufzunehmen. Wenn die Tiere jedoch zuviel Energie auf Fluchtreaktionen verwenden müssen, könnte dies einen Anstieg der Mortalitätsrate verursachen. Auf lange Sicht könnte eine erhöhte Mortalität der Schweinswale negative Auswirkungen auf Populationsebene und letzten Endes auch auf den Gesamtbestand in der Nordsee haben (Haelters et al. 2013). Auch hier können Schallschutzsysteme zu einer Verminderung möglicher negativer Effekte auf Populationsebene beitragen.

Nicht nur in der Konstruktionsphase, auch während Betriebs des Windparks alpha ventus waren Auffälligkeiten zu beobachten. So wurden 2012 deutlich höhere Aktivitäten als 2008 gemessen, was mit sogenannten Riffeffekten zusammenhängen könnte, welche allerdings nur in Umgebungen mit weichem Substrat zum Tragen kommen. Turbinenfundamente stellen künstliche Hartsubstrate dar, die im Laufe der Jahre von einer vielfältigen Fauna besiedelt werden können, was bei einigen Fischarten zu erhöhten Dichten führen kann. Diese wiederum wären eine mögliche Ursache erhöhter Schweinswaldichten einige Jahre nach einer Windpark-Errichtung. Die erhöhten Werte in 2012 könnten teilweise auch durch das Anwachsen der Schweinswal-Bestände in der südlichen Nordsee in den letzten Jahren bedingt sein (Hammond et al. 2013). Als unwahrscheinlich erachtet wurde hingegen ein Vertreibungseffekt des Turbinenlärms auf Schweinswale.

Die Schweinswalaktivität war in den ersten beiden Jahren der Operationsphase (2010 und 2011) im Nahbereich um den Windpark signifikant geringer als während der Basisuntersuchung aus dem Jahr 2008. Ein aufgrund intensiver Wartungsarbeiten erhöhter Schiffsverkehr in diesem Zeitraum könnte eine mögliche Ursache für dieses Muster gewesen sein. alpha ventus ist ein relativ kleiner Offshore-Windpark. Wenn ähnliche längerfristige Effekte durch Untersuchungen bei größeren Windparks bestätigt würden, könnten kumulative Effekte von Windparks auf diese Meeressäuger noch weitreichender und langfristiger sein, da auch Wartungsarbeiten sowie die Größe der Windparks in solche Überlegungen eingeschlossen werden müssten. Die Relevanz kumulativer Effekte und die Wichtigkeit von Schallschutzsystemen wurden international bereits erkannt (z.B. Danish Energy Agency 2013) und spielen auch im aktuellen Schallschutzkonzept des BMU eine wichtige Rolle (BMU 2013).

Da Effekte der Rammungen für alpha ventus auf Schweinswale kurzfristiger Natur waren und die längerfristigen Effekte während der Operationsphase räumlich eng begrenzt waren, werden negative Auswirkungen des sehr kleinen OWP alpha ventus auf die Schweinswale der Nordsee auf Populationsebene für unwahrscheinlich erachtet. Dies wird auch durch die Tatsache gestützt, dass keine wesentlichen Verschiebungen im phänologischen Auftreten und regionalen Verteilungsmuster der Tiere festgestellt wurden.

Zukünftige Studien sollten dennoch eventuelle Populationseffekte des Baus von Windparks auf Meeressäuger im Fokus behalten, welche möglicherweise durch die aktuell rasanten Entwicklungen im Offshore-Energiesektor mit allgemein wesentlich größeren Offshore-Windparks verursacht werden könnten. Ein vielversprechender Ansatz in Form eines konzeptionellen Modells, welches die möglichen Auswirkungen anthropogener Lärmbelastung auf Meeressäuger umreißt, wurde vom National Research Council of the United States National Academy of Sciences (NRC) entwickelt und unter dem Begriff ‚Population Consequences of Acoustic Displacement‘ (PCAD) veröffentlicht (NRC 2005). PCAD-Modelle könnten dabei helfen, die räumliche und zeitliche Reichweite von Effekten genauer einzugrenzen und bessere, biologisch relevantere Grenzwerte (z.B. für Lärmpegel, Rammdauer und Windparkgröße) zu ermitteln, oberhalb derer negative Konsequenzen für Meeressäuger auf Populationsebene möglich sind. In diesem Zusammenhang liefern die Ergebnisse unserer Studie einen wichtigen Mosaikbaustein für zukünftige PCAD-Modelle, welche die Auswirkungen von Offshore-Windparks auf Schweinswal-Populationen besser abschätzen.

7 REFERENCES

- ADELUNG, D., HEIDEMANN, G., FRESE, K., DUINKER, J., HAASE, E. & G. SCHULZ (1997): Untersuchung an Kleinwalen als Grundlage eines Monitorings. BMBF-Projekt 03F0139A. Final report.
- ADELUNG, D. & G. MÜLLER (2008): Teilprojekt 6 – Telemetrische Untersuchungen zur räumlichen und zeitlichen Nutzung des Schleswig-Holsteinischen Wattenmeeres und des angrenzenden Seegebietes durch Seehunde (*Phoca vitulina vitulina*) in Hinblick auf die Errichtung von Offshore-Windparks. In: Marine Warmblüter in Nord- und Ostsee: Grundlagen zur Bewertung von Windkraftanlagen im Offshore-Bereich. In: Final Report of the Minos-plus project „Weiterführende Arbeiten an Seevögeln und Meeressäugern zur Bewertung von Offshore-Windkraftanlagen“ (MINOSplus). Report on behalf of the German federal ministry of the environment, nature conservation and nuclear safety (BMU), FKZ 0329946C. Kiel University, Kiel.
- AKAMATSU, T., TEILMANN, J. T., MILLER, L. A., TOUGAARD, J., DIETZ, R., WANG, D., WANG, K., SIEBERT, U. & Y. NAITO (2007): Comparison of echolocation behaviour between coastal and riverine porpoises. *Deep-Sea Research II* 54: 290-297.
- AU, W. W. L., KASTELEIN, R. A., RIPPE, T. & N. M. SCHOONEMAN (1999): Transmission beam pattern and echolocation signals of a harbor porpoise (*Phocoena phocoena*). *J Acoust Soc Am* 106: 3699-3705.
- BAILEY, H., SENIOR, B., SIMMONS, D., RUSIN, J., PICKON, G. & P. M. THOMPSON (2010): Assessing underwater noise levels during pile-driving at an offshore windfarm and its potential effects on marine mammals. *Marine Pollution Bulletin* 60: 888-897.
- BARLOW, J. (1988): Harbor porpoise, *Phocoena phocoena*, abundance estimation for California, Oregon, and Washington: I Ship surveys. *Fish Bull* 86: 417-432.
- BETKE K. & M. SCHULTZ-VON GLAHN (2008): Prognose des Unterwassergeräusches beim Bau und beim Betrieb des Offshore-Windparks Borkum-West („Alpha ventus“) und Messung des Hintergrundgeräusches im Planungsgebiet. ITAP, Oldenburg.
- BETKE K. & R. MATUSCHEK (2011): Messungen von Unterwasserschall beim Bau der Windenergieanlagen im Offshore-Testfeld "Alpha ventus". Final report for monitoring after StUK3 in the construction phase. ITAP, Oldenburg.
- BETKE K. & R. MATUSCHEK (2012): Messungen von Unterwasserschall beim Betrieb der Windenergieanlagen im Offshore-Windpark alpha ventus. StUKplus Report on behalf of BSH. ITAP, Oldenburg.
- BORAN, J. R., EVANS, P. G. H., REID, J. B. & S. NORTHRIDGE (1999): Cetaceans in northeastern Atlantic waters: using diverse sightings sources to monitor distribution and relative abundance. In: PARSONS, E. C. M. & P. G. H. EVANS (eds): *European Research on Ceta-*

- ceans 12. Proc 12th Ann Conf ECS, 20-24 Jan 1998, Monaco. European Cetacean Society, Valencia, Spain: 81-88.
- BORCHERS, D. L., BUCKLAND, S. T. & W. ZUCCHINI (2002): Estimating animal abundance: closed populations. Springer, London.
- BRANDT, M., DIEDERICHS, A. & G. NEHLS (2008): Fachgutachten Meeressäuger. Im Rahmen der Umweltverträglichkeitsstudie für das Sandentnahmegebiet "Westerland III" westlich von Sylt. BioConsult SH, Husum.
- BRANDT, M. J., DIEDERICHS, A. & G. NEHLS (2009a): Harbour porpoise responses to pile driving at the Horns Rev II offshore windfarm in the Danish North Sea. Report to DONG Energy. BioConsult SH, Husum.
- BRANDT, M. J., DIEDERICHS, A. & G. NEHLS (2009b): Einfluss der Rammarbeiten zur Errichtung der Forschungsplattform FINO III auf Schweinswale (*Phocoena phocoena*). Report to the German federal ministry of the environment, nature conservation and nuclear safety (BMU). BioConsult SH, Husum.
- BRANDT, M. J., DIEDERICHS, A., BETKE, K. & G. NEHLS (2011): Responses of harbour porpoises to pile driving at the Horns Rev II offshore windfarm in the Danish North Sea. Mar Ecol Prog Ser 421: 205-216.
- BRANDT, M. J., DIEDERICHS, A., BETKE, K. & G. NEHLS (2012): Effects of offshore pile driving at the Horns Rev II offshore windfarm in the Danish North Sea. In: POPPER, A. N. & A. HAWKINS (eds.): The effects of noise on aquatic life. Advances in Experimental Medicine and Biology 730: 281-284. Springer Science and Business Media. doi 10.1007/978-1-4419-7311-5_62.
- BRANDT, M. J., HANSEN, S., DIEDERICHS, A. & G. NEHLS (2014): Do man-made structures and water depth affect the diel rhythms in click recordings of harbor porpoises (*Phocoena phocoena*)? Marine Mammal Science. doi: 10.1111/mms.12112.
- BRASSEUR, S., REIJNDERS, P., HENRIKSEN, O.D., CARSTENSEN, J., TOUGAARD, J., TEILMANN, J., LEOPOLD, M., CAMPHUYSEN, K. & J. GORDON (2004): Baseline data on the harbour porpoise, *Phocoena phocoena*, in relation to the intended windfarm site NSW, in the Netherlands. Alterra-rapport 1043. Alterra, Wageningen.
- BUCKLAND, S. T. & S. T. TURNOCK (1992): A robust line transect model. Biometrics 48: 901-909.
- BUCKLAND, S. T., ANDERSON, D. R., BURNHAM, K. P. & J. L. LAAKE (1993): Distance sampling: estimating abundance of biological populations. Chapman & Hall, London.
- BUCKLAND, S. T., ANDERSON, D. R., BURNHAM, K. P., LAAKE, J. L., BORCHERS, D. L. & L. THOMAS (2001): Introduction to distance sampling – Estimating abundance of biological populations. Oxford University Press.

- BUCKLAND, S. T., BURT, L. M., REXSTAD, E. A., MELLOR, M., WILLIAMS, A. E. & R. WOODWARD (2012): Aerial surveys of seabirds: the advent of digital methods. *Journal of Applied Ecology* 49: 960-967.
- BUNDESAMT FÜR SEESCHIFFFAHRT UND HYDROGRAPHIE (BSH) (2007): Standard – Investigation of the impacts of offshore wind turbines on the marine environment (StUK 3). BSH-Nr. 7003. Bundesamt für Seeschifffahrt und Hydrographie (BSH), Hamburg & Rostock.
- BUNDESAMT FÜR SEESCHIFFFAHRT UND HYDROGRAPHIE (BSH) (2010): Leitsätze für die Anwendung der Eingriffsregelung innerhalb der ausschließlichen Wirtschaftszone und auf dem Festlandsockel im Rahmen von § 58 Abs. 1 Satz 2 BNatSchG. URL: http://www.bsh.de/de/Meeresnutzung/Wirtschaft/Windparks/Grundlagen/Leitsaetze_Eingriffsregelung.pdf. Accessed 11 Jul 2013.
- BUNDESAMT FÜR SEESCHIFFFAHRT UND HYDROGRAPHIE (BSH) (2013): Standard – Investigation of the impacts of offshore wind turbines on the marine environment (StUK 4). BSH-Nr. 7003. Bundesamt für Seeschifffahrt und Hydrographie (BSH), Hamburg & Rostock.
- BUNDESMINISTERIUM FÜR UMWELT, NATURSCHUTZ UND REAKTORSICHERHEIT (BMU) (2013): Konzept für den Schutz der Schweinswale vor Schallbelastungen bei der Errichtung von Offshore-Windparks in der deutschen Nordsee (Schallschutzkonzept). URL: http://www.bfn.de/fileadmin/MDB/documents/themen/erneuerbareenergien/Strategie_Positionspapiere/schallschutzkonzept_BMU.pdf. Accessed 07 Jan 2014.
- CAMPHUYSEN, C. J. (2004): The return of the harbor porpoise (*Phocoena phocoena*) in Dutch coastal waters. *Lutra* 47: 113-122.
- CAMPHUYSEN, C. J. (2011): Recent trends and spatial patterns in nearshore sightings of harbour porpoises (*Phocoena phocoena*) in the Netherlands (Southern Bight, North Sea), 1990-2010. *Lutra* 54: 39-57.
- CLAUSEN, K. T., WAHLBERG, M., BEEDHOLM, K., DERUITER, S. & P. T. MADSEN (2011): Click communication in harbour porpoises *Phocoena phocoena*. *The International Journal of Animal Sound and its Recording* 20 (1): 1-28. doi: 10.1080/09524622.2011.9753630.
- COATES, D., DESCHUTTER, J., VINCX, M. & J. VANAUVERBEKE (2013): Macrobenthic enrichment around a gravity based foundation. In: DEGRAER, S., BRABANT, R. & B. RUMES (eds.): Environmental impacts of offshore windfarms in the Belgian part of the North Sea. Royal Belgian Institute of Natural Sciences (RBINS), Brussels, Belgium. pp. 141-151.
- DÄHNE, M., GILLES, A., LUCKE, K., PESCHKO, V., ADLER, S., KRÜGEL, K., SUNDERMEYER, J. & U. SIEBERT (2013): Effects of pile-driving on harbour porpoises (*Phocoena phocoena*) at the first offshore windfarm in Germany. *Environ Res Lett* 8: 025002. doi: 10.1088/1748-9326/8/2/025002.
- DANISH ENERGY AGENCY (2013): Danish Offshore Wind. Key Environmental Issues – a Follow-up. The Environmental Group. The Danish Energy Agency. The Danish Nature Agency, DONG Energy & Vattenfall.

- DEGRAER, S., BRABANT, R. & B. RUMES (eds) (2013): Environmental impacts of offshore wind-farms in the Belgian part of the North Sea. Royal Belgian Institute of Natural Sciences (RBINS), Brussels, Belgium.
- DE MESEL, I., KERCKHOF, F., RUMES, B., NORRO, A., HOUZIAUX, J.-S. & S. DEGRAER (2013): Fouling community on the foundations of wind turbines and the surrounding scour protection. In: DEGRAER, S., BRABANT, R. & B. RUMES (eds.): Environmental impacts of offshore windfarms in the Belgian part of the North Sea. Royal Belgian Institute of Natural Sciences (RBINS), Brussels, Belgium. pp. 123-137.
- DIEDERICHS, A., GRÜNKORN, T. & G. NEHLS (2002): Erprobung von Klickdetektoren zur Erfassung von Schweinswalen im Sommer und Herbst 2002 im Seegebiet westlich von Sylt. Report on behalf of Offshore-Bürger-Windpark-Butendiek GmbH & Co.KG. BioConsult SH, Husum.
- DIEDERICHS, A., GRÜNKORN, T. & G. NEHLS (2004): Einsatz von Klickdetektoren zur Erfassung von Schweinswalen im Seegebiet westlich von Sylt. BioConsult SH, Husum.
- DIEDERICHS, A., BRANDT, M. J. & G. NEHLS (2008a): Basisuntersuchung im Frühjahr 2008 am Offshore-Testfeld „alpha ventus“. Untersuchungen zu Schweinswalen mit T-PODs. BioConsult SH, Husum.
- DIEDERICHS, A., HENNING, V. & G. NEHLS (2008b): Investigations on the bird collision risk and the responses of harbour porpoises in the offshore windfarm Horns Rev, North Sea and Nysted, Baltic Sea, in Denmark, Part II: harbour porpoises. Final report on behalf of the German federal ministry of the environment, nature conservation and nuclear safety (BMU). BioConsult SH, Husum.
- DIEDERICHS, A., NEHLS, G., DÄHNE, M., ADLER, S., KOSCHINSKI, S. & U. VERFUß (2008c): Methodologies for measuring and assessing potential changes in marine mammal behaviour, abundance or distribution arising from the construction, operation and decommissioning of offshore windfarms. Report on behalf of COWRIE Ltd. BioConsult SH, Husum.
- DIEDERICHS, A., BRANDT, M. & G. NEHLS (2009a): Auswirkungen des Baus des Umspannwerks am Offshore-Testfeld „alpha ventus“ auf Schweinswale. Untersuchungen zu Schweinswalen mit T-PODs. BioConsult SH, Husum & Biola, Hamburg.
- DIEDERICHS, A., BRANDT, M. & G. NEHLS (2009b): Auswirkungen der Vergrämungsmaßnahmen auf Schweinswale beim Bau des Offshore-Testfeldes „alpha ventus“. Untersuchungen zu Schweinswalen mit T-PODs. BioConsult SH, Husum & Biola, Hamburg.
- DIEDERICHS, A., BRANDT, M. J., NEHLS, G., LACZNY, M., HILL, A. & W. PIPER (2010): Auswirkungen des Baus des Offshore-Testfeldes „alpha ventus“ auf marine Säugetiere. BioConsult SH, Husum & Biola, Hamburg.
- DIEDERICHS, A., PEHLKE, H., NEHLS, G., BELLMANN, M., GERKE, P., OLDELAND, J., GRUNAU, C. WITTE, S. & A. ROSE (2014): Entwicklung und Erprobung des Großen Blasenschleiers zur

- Minderung der Hydroschallemissionen bei Offshore-Rammarbeiten. Report on behalf of the German federal ministry of the environment, nature conservation and nuclear safety (BMU), FKZ 0325309 A/B/C. BioConsult SH, Husum & ITAP, Oldenburg.
- EUROPEAN COUNCIL (1992): Council Directive 92/43/EEC of 21 May 1992 on the conservation of natural habitats and of wild fauna and flora. Report 01992L0043-20070101. URL: <http://eur-lex.europa.eu/LexUriServ/LexUriServ.do?uri=CONSLEG:1992L0043:20070101:EN:PDF>.
- EVANS, P. G. H., SWANN, C., LEWIS, E., PARSONS, E., HEIMLICH-BORAN, J. & S. HEIMLICH-BORAN (1993): Survey of cetaceans in the minches and Sea of Hebrides, Northwest Scotland. In: EVANS, P.G.H. (ed): European Research on Cetaceans 7, Proc 7th Ann Conf ECS, 18-21 Feb 1993, Inverness, Scotland. European Cetacean Society, Cambridge, England: 111-117.
- GEELHOED, S. C. V., SCHEIDAT, M., VAN BEMMELEN, R. S. A. & G. AARTS (2013): Abundance of harbour porpoises (*Phocoena phocoena*) the Dutch Continental Shelf, aerial surveys in July 2010-March 2011. *Lutra* 56 (1): 45-57.
- GILLES, A., HERR, H., RISCH, D., SCHEIDAT, M. & U. SIEBERT (2006): Erfassung von Meeressäugtieren und Seevögeln in der deutschen AWZ von Nord- und Ostsee (EMSON) – Teilvorhaben: Erfassung von Meeressäugtieren. Forschungs- und Technologiezentrum Westküste, Büsum.
- GILLES, A., HERR, H., LEHNERT, K., SCHEIDAT, M., KASCHNER, K., SUNDERMEYER, J., WESTERBERG, U. & U. SIEBERT (2007): MINOS Teilvorhaben 2 – "Erfassung der Dichte und Verteilungsmuster von Schweinswalen (*Phocoena phocoena*) in der deutschen Nord- und Ostsee". Forschungs- und Technologiezentrum Westküste, Büsum.
- GILLES, A. & U. SIEBERT (2009): Erprobung eines Bund/Länder-Fachvorschlags für das Deutsche Meeresmonitoring von Seevögeln und Schweinswalen als Grundlage für die Erfüllung der Natura 2000-Berichtspflichten mit einem Schwerpunkt in der deutschen AWZ von Nord- und Ostsee. (FFH-Berichtsperiode 2007-2012) Teilbericht: Visuelle Erfassung von Schweinswalen. Report on behalf of BfN. Forschungs- und Technologiezentrum Westküste, Büsum & Deutsches Meeresmuseum Stralsund. URL: http://www.bfn.de/habitatmare/de/downloads/monitoring/BfN-Monitoring_MarineSaeuetiere_2008-2009.pdf. Accessed 14 Jan 2014.
- GILLES, A., SIEBERT, U., GALLUS, A., DÄHNE, M. & H. BEHNKE (2010): Marine Säugetiere und Seevögel in der deutschen AWZ von Nord- und Ostsee – Teilbericht marine Säugetiere. Report on behalf of BfN. Forschungs- und Technologiezentrum Westküste, Büsum & Deutsches Meeresmuseum Stralsund.
- GILLES, A., PESCHKO, V. & U. SIEBERT (2011): Monitoringbericht 2010-2011. Marine Säugetiere und Seevögel in der deutschen AWZ von Nord- und Ostsee. Teilbericht: Marine Säugetiere. A. Visuelle Erfassung von Schweinswalen und akustische Erfassung im See-

gebiet Doggerbank. Report on behalf of BfN. Stiftung Tierärztliche Hochschule Hannover & Deutsches Meeresmuseum Stralsund.

- GOODSON, A. D. & S. DATTA (1995): Investigating the sonar signals of the harbour porpoise *Phocoena phocoena*. *J Acoust Soc India* 23: 205-211.
- GORDON, J., THOMPSON, D., GILLESPIE, D., LONERGAN, M., CALDERAN, S., JAFFEY, B. & V. TODD (2007): Assessment of the potential for acoustic deterrents to mitigate the impact on marine mammals of underwater noise arising from the construction of offshore windfarms. COWRIE Ltd, Report: COWRIE DETER-01-2007. URL: http://mhk.pnnl.gov/wiki/images/c/cc/Gordon_et_al_2007.pdf. Accessed 25 Jul 2013.
- GUNNLAUGSSON, T., SIGURJONSSON, J. & G. P. DONOVAN (1988): Aerial surveys of cetaceans in the coastal waters off Iceland, June – July 1986. *Rep Int Whal Commn* 38: 489-500.
- GRÜNKORN, T., DIEDERICHS, A. & G. NEHLS (2004): Fachgutachten Meeressäuger: Linientranssektzählungen mit Flugzeug und Schiff westlich von Sylt. Zwischenbericht für den Untersuchungszeitraum von Mai 2002 bis Dezember 2003. Report on behalf of Offshore-Bürger-Windpark-Butendiek GmbH & Co.KG. BioConsult SH, Husum.
- HAELTERS, J. & C. J. CAMPHUYSEN (2008): The harbour porpoise in the southern North Sea: Abundance, threats and research & management proposals. Report commissioned by IFAW EU office.
- HAELTERS, J., JACQUES, T. G., KERCKHOF, F. & S. DEGRAER (2010): Spatio-temporal patterns of the harbour porpoise *Phocoena phocoena* in the Belgian part of the North Sea. In: DEGRAER, S., BRABANT, R. & B. RUMES (eds.): Offshore windfarms in the Belgian part of the North Sea: early environmental impact assessment and spatio-temporal variability. Royal Belgian Institute of Natural Sciences, Brussels, Belgium. pp. 153-163.
- HAELTERS, J., KERCKHOF, F., JACQUES, T. G. & S. DEGRAER (2011): The harbour porpoise *Phocoena phocoena* in the Belgian part of the North Sea: trends in abundance and distribution. *Belgian Journal of Zoology* 141: 75.
- HAELTERS, J., VAN ROY, W., VIGIN, L. & S. DEGRAER (2012): The effect of pile driving on harbour porpoises in Belgian waters. In: DEGRAER, S., BRABANT, R. & B. RUMES (eds.): Offshore windfarms in the Belgian part of the North Sea. Heading for an understanding of environmental impacts. Royal Belgian Institute of Natural Sciences, Brussels. Management Unit of the North Sea Mathematical Models, Marine ecosystem management unit. 155 pp. + annexes. pp. 127-143.
- HAELTERS, J., DEBUSSCHERE, E., BOTTELDOOREN, D., DULIÈRE, V., HOSTENS, K., NORRO, A., VANDENDRIESSCHE, S., VIGIN, L., VINCX, M. & S. DEGRAER (2013): The effects of pile driving on marine mammals and fish in Belgian waters. In: DEGRAER, S., BRABANT, R. & B. RUMES (eds.): Environmental impacts of offshore windfarms in the Belgian part of the North Sea. Royal Belgian Institute of Natural Sciences (RBINS), Brussels, Belgium. pp. 71-77.

- HAMMOND, P. S. (1986): Estimating the size of naturally marked whale populations using capture-recapture techniques. Rep Int Whal Commn, Special Issue 8: 253-282.
- HAMMOND, P. S., BENKE, H., BERGGREN, P., BORCHERS, D. L., BUCKLAND, S. T., COLLET, A., HEIDE-JØRGENSEN, M. P., HEIMLICH-BORAN, S., HIBY, A. R., LEOPOLD, M. F. & N. ØIEN (1995): Distribution and abundance of the harbour porpoise and other small cetaceans in the North Sea and adjacent waters. EU-Project LIFE 92-2/UK/027, Final report.
- HAMMOND, P. S., MACCLEOD, K., BERGGREN, P., BORCHERS, D. L., BURT, L., CAÑADAS, A., DESPORTES, G., DONOVAN, G. P., GILLES, A., GILLESPIE, D., GORDON, J., HIBY, L., KUKLIK, I., LEAPER, R., LEHNERT, K., LEOPOLD, M., LOVELL, P., ØIEN, N., PAXTON, C. G. M., RIDOUX, V., ROGAN, E., SAMARRA, F., SCHEIDAT, M., SEQUEIRA, M., SIEBERT, U., SKOV, H., SWIFT, R., TASKER, M.L., TEILMANN, J., VAN CANNEYT, O. & J. A. VÁZQUEZ (2013): Cetacean abundance and distribution in European Atlantic shelf waters to inform conservation and management. *Biological Conservation* 164: 107-122.
- HANSEN, S., HÖSCHLE, C., DIEDERICHS, A., NEHLS, G., LACZNY, M. & W. PIPER (2013): Offshore-Testfeld alpha ventus. Fachgutachten Meeressäuger. 2. Untersuchungsjahr der Betriebsphase (Januar – Dezember 2011). BioConsult SH, Husum & IfAÖ, Hamburg.
- HASTIE, T. J. & R. J. TIBSHIRANI (1990): Generalized Additive Models. Chapman and Hall, New York.
- HAUPT, H., LUDWIG, G., GRUTKE, H., BINOT-HAFKE, M., OTTO, C. & A. PAULY (eds.) (2009): Rote Liste gefährdeter Tiere, Pflanzen und Pilze Deutschlands. Band 1: Wirbeltiere. Bundesamt für Naturschutz, Bonn-Bad Godesberg. *Naturschutz und Biologische Vielfalt* 70 (1): 1-386.
- HEIDE-JØRGENSEN, M. P., MOSBECH, A., TEILMANN, J., BENKE, H. & W. SCHULTZ (1992): Harbour porpoise densities obtained from aerial surveys north of Fyn and in the Bay of Kiel. *Ophelia* 35 (2): 133-146.
- HEIDE-JØRGENSEN, M. P., TEILMANN, J., BENKE, H. & J. WULF (1993): Abundance and distribution of harbour porpoises *Phocoena phocoena* in selected areas of the western baltic and the North Sea. *Helgoländer Meeresunters* 47: 335-346.
- HÖSCHLE, C., DIEDERICHS, A., NEHLS, G., LACZNY, M. & W. PIPER (2011): Statusbericht Meeressäuger im Bereich des Offshore-Testfeldes alpha ventus. BioConsult SH, Husum & Biola, Hamburg.
- IFAW (2011): Final report for a survey for harbour porpoises (*Phocoena phocoena*) of the Dogger Bank and southern North Sea conducted from R/V Song of the Whale, 7th-24th November 2011. Marine Conservation Research International, Essex, UK.
- INSTITUT FÜR ANGEWANDTE ÖKOLOGIE (IfAÖ) (2013): Fischbiologische Untersuchungen im Offshore Windpark „alpha ventus“. Bericht über das 3. Betriebsjahr (Frühjahr und Herbst 2012). Report on behalf of Stiftung Offshore Windenergie. IfAÖ, Hamburg.

- ITO, J., NIKOLAEV, A.R., LUMAN, M., AUKES, M. F., NAKATANI, C. & C. VAN LEEUWEN (2003): Perceptual switching, eye movements, and the bus paradox. *Perception* 32: 681-698.
- KAMMINGA, C. & H. WIERSMA (1981): Investigations of cetacean sonar II: Acoustical similarities and differences in odontocete sonar signals. *Aquatic Mammals* 8: 41-62.
- KASTELEIN, R. A., GRANSIER, R., HOEK, L. & J. OLTHUIS (2012): Temporary threshold shifts and recovery in a harbor porpoise (*Phocoena phocoena*) after octave-band noise at 4 kHz. *J Acoust Soc Am* 132(5): 3525-3537.
- KOSCHINSKI, S., CULIK, B. M., HENRIKSEN, O. D., TREGENZA, N., ELLIS, G., JANSEN, C. & G. KATHE (2003): Behavioural reactions of free-ranging porpoises and seals to the noise of a simulated 2 MW windpower generator. *Mar Ecol Prog Ser* 265: 263-273.
- KYHN, L. A., TOUGAARD, J., THOMAS, L., DUVE, L. R., STENBACK, J., AMUNDIN, M., DESPORTES, G. & J. TEILMANN (2012): From echolocation clicks to animal density – Acoustic sampling of harbor porpoises with static dataloggers. *J Acoust Soc Am* 131(1): 550-560.
- LACZNY, M., PIPER, W., GAUGER, M., NEHLS, G., DIEDERICHS, A. & T. GRÜNKORN (2009): Fachgutachten Meeressäugtiere. Untersuchungsgebiet: „alpha ventus“. Betrachtungszeitraum Juli bis Oktober 2008. Unpublished report on behalf of Stiftung Offshore-Windenergie. BioConsult SH, Husum & Biola, Hamburg.
- LEOPOLD, M. F. & C. J. CAMPHUYSEN (2008): Did the pile driving during the construction of the Offshore Windfarm Egmond aan Zee, the Netherlands, impact porpoises? Report on behalf of NoordZeeWind. Wageningen IMARES, Texel.
- LINNENSCHMIDT, M., TEILMANN, J., AKAMATSU, T., DIETZ, R. & A. MILLER (2013): Biosonar, dive, and foraging activity of satellite tracked harbor porpoises (*Phocoena phocoena*). *Marine Mammal Science* 29(2): E77-E97. doi: 10.1111/j.1748-7692.2012.00592.x.
- LUCKE, K., LEPPER, P., BLANCHET, M.-A. & U. SIEBERT (2009): Temporary shift in masked hearing thresholds in a harbour porpoise (*Phocoena phocoena*) after exposure to seismic airgun stimuli. *J Acoust Soc Am* 125: 4060-4070.
- MASON, T. I. & R. J. BARHAM (2013): Underwater noise modelling of impact piling in support of the Horns Rev 3 Offshore Windfarm. Subacoustech Environmental Report No. E390R0104.
- MIKKELSEN, L., MOURITSEN, K. N., DAHL, K., TEILMANN, J. & J. TOUGAARD (2013): Re-established stony reef attracts harbour porpoises *Phocoena phocoena*. *Mar Ecol Prog Ser* 481: 239-248.
- MILLER, L. A. & M. WAHLBERG (2013): Echolocation by the harbor porpoise: life in coastal waters. *Frontiers in Physiology* 4 (Article 52). doi: 10.3389/fphys.2013.00052.
- NABE-NIELSEN, J., SIBLY, R. M., TOUGAARD, J., TEILMANN, J. & S. SVEEGAARD (2014): Effects of noise and by-catch on a Danish harbour porpoise population. *Ecological Modelling* 272: 242-251. doi: <http://dx.doi.org/10.1016/j.ecolmodel.2013.09.025>.

- NACHTIGALL, P. E. & A. Y. SUPIN (2013): A false killer whale reduces its hearing sensitivity when a loud sound is preceded by a warning. *Journal of Experimental Biology* 04/2013. doi: 10.1242/jeb.085068.
- NEHLS, G. (2008): Vergrämung von marinen Säugetieren beim Bau des Offshore-Windparks alpha ventus. BioConsult SH, Husum.
- NORRO, A. M. J., RUMES, B. & S. J. DEGRAER (in press): Differentiating between underwater construction noise of monopile and jacket foundations for offshore windmills: a case study from the Belgian part of the North Sea. *The Scientific World Journal* 2013. URL: <http://dx.doi.org/10.1155/2013/897624>. Accessed 12 Dec 2013.
- National Research Council. (2005). *Marine Mammal Populations and Ocean Noise: Determining when noise causes biologically significant effects*. The National Academy Press. Washington D.C.
- PALKA, D. (1995): Abundance estimate of the Gulf of Maine harbor porpoise. In: BØRGE, A. & G.P. DONOVAN (eds): *Biology of the Phocoenids*. Rep Int Whal Commn, Special Issue 16: 27-50.
- PIPER, W., KULIK, G., LACZNY, M., VON DER HEYDE, L. & V. BROCK (2008): Fachgutachten Vögel – hier: Rastvögel. Untersuchungsgebiet: alpha ventus. Betrachtungszeitraum: Februar bis Juni 2008. Unpublished report on behalf of Stiftung Offshore-Windenergie. Biola, Hamburg & BioConsult SH, Husum.
- POLACHEK, T. (1995): Double team field tests of line transect methods for shipboard sighting surveys for harbor porpoises. - In: BØRGE, A. & G.P. DONOVAN (eds): *Biology of the Phocoenids*. Rep Int Whal Commn, Special Issue 16: 51-68.
- POLACHEK, T., & L. THORPE (1990): The swimming direction of harbor porpoise in relation to survey vessel. *Rep Int Whal Commn* 40: 463-470.
- PROCHNOW, G. (1998): Grundlagen für den Schutz von Schweinswalen (*Phocoena phocoena*) im Seegebiet westlich der Insel Amrum und Sylt. Diploma thesis. Hamburg University, Hamburg.
- R DEVELOPMENT CORE TEAM (2007): *R: A Language and Environment for Statistical Computing*. The R Foundation for Statistical Computing, Vienna, Austria. URL: <http://www.r-project.org/>. Accessed 08 Nov 2013.
- READ, A. J. & A. A. HOHN (1995): Life in the fast lane: The life history of harbour porpoises from the Gulf of Maine. *Marine Mammals Science* 11(4): 423-440.
- REID, J. B., EVANS, P. G. H. & S. P. NORTHLEDGE (2003): *Atlas of Cetacean distribution in north-west European waters*. Joint Nature Conservation Committee, Peterborough, U.K.
- REUBENS, J., DEGRAER, S. & M. VINCX (2013): Offshore windfarms significantly alter fish community structure – Aggregation of Atlantic cod and pouting. In: DEGRAER, S., BRABANT, R. & B. RUMES (eds.): *Environmental impacts of offshore windfarms in the Belgian*

- part of the North Sea. Royal Belgian Institute of Natural Sciences (RBINS), Brussels, Belgium. pp. 115-121.
- RUMES, B., COATES, D., DE MESEL, I., DERWEDUWEN, J., KERCKHOF, F., REUBENS, J. & S. VANDENDRIESSCHE (2013): Does it really matter? Changes in species richness and biomass at different spatial scales. In: DEGRAER, S., BRABANT, R. & B. RUMES (eds.): Environmental impacts of offshore windfarms in the Belgian part of the North Sea. Royal Belgian Institute of Natural Sciences (RBINS), Brussels, Belgium. pp. 183-189.
- SCHEIDAT, M., KOCK, K.-H. & U. SIEBERT (2003). Summer distribution of harbour porpoises *Phocoena phocoena* in German waters. Paper presented to 10th AC ASCOBANS meeting, 9-11 April 2003.
- SCHEIDAT, M., KOCK, K.-H. & U. SIEBERT (2004): Summer distribution of harbour porpoises (*Phocoena phocoena*) in the German North Sea and Baltic Sea. J Cetacean Res Manage 6: 251-257.
- SCHEIDAT, M., TOUGAARD, J, BRASSEUR, S., VAN POLANEN PETEL, T., TEILMANN, J. & P. REIJNDERS (2011): Harbour porpoises (*Phocoena phocoena*) and windfarms: a case study in the Dutch North Sea. Environ Res Lett 6. doi: 10.1088/1748-9326/6/2/025102.
- SIEBERT, U. & J. RYE (2008): Excursus 2: Correlation between aerial surveys and acoustic monitoring. In: WOLLNY-GOERKE, K. & K. ESKILDSEN 2008 (eds): Marine mammals and seabirds in front of offshore wind energy. Teubner Verlag, Wiesbaden.
- SIEBERT, U., GILLES, A., DÄHNE, M., PESCHKO, V., KRÜGEL, K., BENKE, H., LUCKE, K., MÜLLER, S., ADLER, S. & J. SUNDERMEYER (2012): Ergänzende Untersuchungen zum Effekt der Bau und Betriebsphase im Offshore-Testfeld „Alpha ventus“ auf marine Säugetiere. In: BLASCHE, K., DAHLKE, C., BOETHLING, M. & A. BINDER (eds): Ökologische Begleitforschung am Offshore-Testfeldvorhaben „Alpha ventus“ zur Evaluierung des Standarduntersuchungskonzeptes des BSH – StUKplus. Zwischenbericht StUKplus 2011. Report on behalf of BSH. FKZ 0327689A/TiHo1. Tierärztliche Hochschule, Hannover.
- SIEBERT, U., GILLES, A., DÄHNE, M., PESCHKO, V., RUSER, A., MEYER-KLÄDEN, O., BENKE, H., VIQUERAT, S., GIEWAT, H. & K. RONNENBERG (2013): Ergänzende Untersuchungen zum Effekt der Bau und Betriebsphase im Offshore-Testfeld „Alpha ventus“ auf marine Säugetiere. Zwischenbericht StUKplus 2012. Report on behalf of BSH. FKZ 0327689A/TiHo1. Tierärztliche Hochschule, Hannover.
- SONNTAG, R. P., BENKE, H., HIBY, A. R., LICK, R. & D. ADELUNG (1999): Identification of the first harbour porpoise (*Phocoena phocoena*) calving ground in the North Sea. Journal of Sea Research 41: 225-232.
- SOUTHALL, B. L., BOWLES, A. E., ELLISON, W. T., FINNERAN, J. J., GENTRY, R. L., GREENE JR., C. R., KASTAK, D., KETTEN, D. R., MILLER, J. H., NACHTIGALL, P. E., RICHARDSON, W. J., THOMAS, J. A., & P. L. TYACK (2007): Marine mammal noise exposure criteria: initial scientific recommendation. Aquatic Mammals 33: 411-521.

- SVEEGAARD, S., ANDREASEN, H., MOURITSEN, K. N., JEPPESEN, J. P., TEILMANN, J. & C. C. KINZE (2012): Correlation between the seasonal distribution of harbour porpoises and their prey in the Sound, Baltic Sea. *Mar Biol* 159: 1029-1037.
- TEILMANN, J. (1996): Status of the harbour porpoise (*Phocoena phocoena*) in Danish waters. *Rep Int Whal Commn* 46, SC/47/SM46: 619-625.
- TEILMANN, J. (2000): The behaviour and sensory abilities of harbour porpoises (*Phocoena phocoena*) in relation to bycatch in Danish gillnet fishery. University of Southern Denmark, Odense.
- TEILMANN, J., HEIDE-JØRGENSEN, M. P., DIETZ, R., SONNTAG, R. P., BENKE, H., SIEBERT, U. & G. DESPORTES (1997): Diving behaviour of a harbour porpoise (*Phocoena phocoena*) in Danish waters. In: EVANS, P. G. H. (ed): *Proc 11th Ann Conf ECS, Stralsund, Germany*. European Cetacean Society, Stralsund: 201.
- TEILMANN, J., HENRIKSEN, O. D. & J. CARSTENSEN (2001): Status report of the pilot project: Porpoise detectors (PODs) as a tool to study potential effects of offshore windfarm on harbour porpoise at Rødsand. Report for SEAS.
- TEILMANN, J. & J. CARSTENSEN (2012): Negative long term effects on harbour porpoises from a large scale offshore windfarm in the Baltic – evidence of slow recovery. *Environ Res Lett* 7: 045101. doi: 10.1088/1748-9326/7/4/045101.
- TEILMANN, J., TOUGAARD, J. & J. CARSTENSEN (2012): Effects on harbour porpoises from Rødsand 2 Off-shore Windfarm. Aarhus University, DCE – Danish Centre for Environment and Energy, 66 pp. Scientific Report from DCE – Danish Centre for Environment and Energy No. 42. URL: <http://www.dmu.dk/Pub/SR42.pdf>. Accessed 19 Dec 2013.
- TEILMANN, J., CHRISTIANSEN, C. T., KJELLERUP, S., DIETZ, R. & G. NACHMAN (2013): Geographic, seasonal, and diurnal surface behavior of harbor porpoises. *Marine Mammal Science* 29(2): E60-E7. doi: 10.1111/j.1748-7692.2012.00597.x6.
- THAXTER, C. B. & N. H. K. BURTON (2009): High Definition Imagery for Surveying Seabirds and Marine Mammals: A Review of Recent Trials and Development of Protocols. British Trust for Ornithology Report Commissioned by COWRIE Ltd.
- THOMAS, L., LAAKE, J. L., REXSTAD, E., STRINDBERG, S., MARQUES, F. F. C., BUCKLAND, S. T., BORCHERS, D. L., ANDERSON, D. R., BURNHAM, K. P., BURT, M. L., HEDLEY, S. L., POLLARD, J. H., BISHOP, J. R. B. & T. A. MARQUES (2009): Distance 6.0. Release 2. Research Unit for Wildlife Population Assessment, University of St Andrews, Scotland. <http://www.ruwpa.stand.ac.uk/distance/>.
- THOMSEN, F., LACZNY, M. & W. PIPER (2004): Methodik zur Erfassung von Schweinswalen (*Phocoena phocoena*) und anderen marinen Säugern mittels Flugtransekt-Zählungen. *Seevögel* 25 (1): 3-12.

- THOMSEN, F., VAN ELK, N., BROCK, V. & W. PIPER (2005): On the performance of automated porpoise-clickdetectors in experiments with captive harbour porpoises (*Phocoena phocoena*). *J Acoust Soc Am* 118: 37-40.
- TOUGAARD, J. (2013): Test af LF Sonar, Notat fra DCE – Nationalt Center for Miljø og Energi.
- TOUGAARD, J., CARSTENSEN, J., WISZ, M. S., JESPERSEN, M., TEILMANN, J., BECH, N. I. & H. SKOV (2006a): Harbour porpoises on Horns Reef – Effects of the Horns Reef Windfarm. Roskilde, DK. National Environmental Research Institute DHI Water and Environment, Hørsholm.
- TOUGAARD, J., CARSTENSEN, J., ILSTED BECH, N. & J. TEILMANN (2006b): Final report on the effect of Nysted Offshore Windfarm on harbour porpoises. Technical report to Energi E2 A/S. Ministry of the Environment, Roskilde, DK.
- TOUGAARD, J., ROSAGER POULSEN, L., AMUNDIN, M., LARSEN, F., RYE, J., & J. TEILMANN (2006c): Detection function of T-PODs and estimation of porpoise densities. ECS Newsletter No 46 (Special Issue) Proceedings of the workshop Static Acoustic Monitoring of Cetaceans. 20th Annual Meeting of the European Cetacean Society, Gdynia, Poland, 2 April 2006. European Cetacean Society.
- TOUGAARD, J., TEILMANN, J. & S. TOUGAARD (2008): Harbour seal spatial distribution estimated from Argos satellite telemetry: overcoming positioning errors. *Endangered Species Research* 4: 113-122.
- TOUGAARD, J., CARSTENSEN, J. & J. TEILMANN (2009a): Pile driving zone of responsiveness extends beyond 20 km for harbor porpoises (*Phocoena phocoena* (L.)). *J Acoust Soc Am* 126: 11-14.
- TOUGAARD, J., HENRIKSEN, O. D. & L. A. MILLER (2009b): Underwater noise from three types of offshore wind turbines: Estimation of impact zones for harbor porpoise and harbor seals. *J Acoust Soc Am* 125: 3766-3773.
- TRILATERAL SEAL EXPERT GROUP (2013a): Aerial surveys of Harbour Seals in the Wadden Sea in 2013. URL: <http://www.waddensea-secretariat.org/monitoring-tmap/topics/marine-mammals>. Accessed 14 Nov 2013.
- TRILATERAL SEAL EXPERT GROUP (2013b): Aerial surveys of Grey Seals in the Wadden Sea in the season of 2012-2013. URL: <http://www.waddensea-secretariat.org/monitoring-tmap/topics/marine-mammals>. Accessed 14 Nov 2013.
- UMWELTBUNDESAMT (UBA) (2011): Empfehlung von Lärmschutzwerten bei der Errichtung von Offshore-Windenergieanlagen (OOWT). Information Unterwasserlärm, Umweltbundesamt Berlin. URL: <http://www.umweltdaten.de/publikationen/fpdf-l/4118.pdf>. Accessed 11 Jul 2013.
- VANDENDRIESSCHE, S., REUBENS, J., DERWEDUWEN, J., DEGRAER, S. & M. VINCX (2013a): Offshore windfarms as productive sites for fishes? In: DEGRAER, S., BRABANT, R. & B. RUMES

- (eds.): Environmental impacts of offshore windfarms in the Belgian part of the North Sea. Royal Belgian Institute of Natural Sciences (RBINS), Brussels, Belgium. pp. 153-161.
- VANDENDRIESSCHE, S., DERWEDUWEN, J. & K. HOSTENS (2013b): Between the turbines: soft substrate epibenthos and fish. In: DEGRAER, S., BRABANT, R. & B. RUMES (eds.): Environmental impacts of offshore windfarms in the Belgian part of the North Sea. Royal Belgian Institute of Natural Sciences (RBINS), Brussels, Belgium. pp. 99-113.
- VERFUß, U. K., HONNEF, C. G., MEDING, A., DÄHNE, M., ADLER, S., KILIAN, A. & H. BENKE (2008): The history of the German Baltic Sea harbour porpoise acoustic monitoring at the German Oceanographic Museum. Teubner Verlag/GWV Fachverlage GmbH, Wiesbaden: 41-56.
- VERFUß, U. K., DÄHNE, M., MEDING, A., HONNEF, C. G., JABBUSCH, M., ADLER, S., MUNDRY, R., HANSEN RYE, J., CHARWAT, H. & H. BENKE (2007): Teilprojekt 3 Untersuchungen zur Raumnutzung durch Schweinswale in der Nord- und Ostsee mit Hilfe akustischer Methoden (PODs) (FKZ 0329946C). In: Final Report of the Minos-plus projekt Weiterführende Arbeiten an Seevögeln und Meeressäugetieren zur Bewertung von Offshore-Windkraftanlagen (MINOSplus). Stralsund, Germany.
- VIQUERAT, S., HERR, H., GILLES, A., PESCHKO, V., SIEBERT, U., SVEEGARD, S. & J. TEILMANN (2014): Abundance of harbour porpoises (*Phocoena phocoena*) in the western Baltic, Belt Seas and Kattegat. Mar Biol. doi: 10.1007/s00227-013-2374-6.
- WESTGATE, A. J., READ, A. J., BERGGREN, P., KOOPMAN, H. N. & D. E. GASKIN (1995): Diving behaviour of harbour porpoises, *Phocoena phocoena*. Can J Fish Aquat Sci 52: 1064-1073.
- WOOD, S. N. (2004): Stable and efficient multiple smoothing parameter estimation for generalized additive models. Journal of the American Statistical Association 99: 673-686.
- WOOD, S. N. (2006): Generalized Additive Models: An Introduction with R. Chapman and Hall, London.
- ZUUR, A. F., IENO, E. N., WALKER, N. J., SAVELIEV A. A. & G. M. SMITH (2009): Mixed effects models and extensions in ecology with R. Springer, New York.

8 SUPPLEMENTS

8.1 Definitions

<i>1st Waiting time</i>	The first <i>Waiting time</i> after a <i>Pile-driving event</i> ; a time-span of at least ten minutes between the last detected porpoise click before a <i>Pile-driving event</i> was finished and the first click after a <i>Pile-driving event</i> . It is not always defined. <i>2nd to 10th Waiting time</i> followed. Synonymously used: <i>1. (or first) Waiting time</i> .
<i>AIC</i>	<i>Akaike Information Criterion</i> , describing the explanatory power of a model. Lower AIC values refer to more suitable models.
<i>Construction type/period</i>	Period within Phase II with pile-drivings for 'Tripod' (longer <i>Pile-driving events</i>) or 'Jacket' foundations (shorter <i>Pile-driving events</i>).
<i>Control waiting time</i>	Time-congruent <i>Waiting times</i> from Phase I (2008) as control for <i>Waiting times</i> from Phase II (2009).
<i>Day X after piling</i>	Calendarly day <i>X</i> after a <i>Pile-driving day</i> ; with negative sign this is calendarly day <i>X</i> before a <i>Pile-driving day</i> ; (factor, taking values from -6 to 6 with analyses in this report).
<i>Day X before piling</i>	The temporally closest preceding calendarly day without <i>Pile-driving events</i> before a <i>Pile-driving day</i> is defined as <i>Day 1 before piling</i> , or <i>Day -1 after piling</i> . Earlier days are categorised as <i>Day -X after piling</i> .
<i>Deterrence</i>	Often deterrence was conducted before <i>Pile-driving events</i> . Since its effects on the behaviour of harbour porpoises could not clearly be separated from the effects of pile driving, both actions were combined regarding the definition of a <i>Pile-driving phase</i> .
<i>Encounter (time)</i>	Complementary to <i>Waiting time</i> (see 'Main parameters' and Fig. 2-22).
<i>End of pile-driving</i>	Hour containing the last strike of a <i>Pile-driving phase</i> which often, but not always corresponded to the end of pile-driving works at a certain OWT (see <i>Pile-driving phase</i>). The following hour was defined as <i>Hour 1 after Pile-driving</i> .
<i>GAM</i>	<i>Generalised Additive Model</i> : A model allowing for inclusion of non-linear distributions of the dependent variable.
<i>GLM</i>	<i>Generalised Linear Model</i> : A model allowing for inclusion of more linear distributions of the dependent variable than a simple <i>LM</i> .

<i>GLMM</i>	<i>Generalised Linear Mixed-Effects Model</i> : a <i>GLM</i> considering fixed effects and random effects simultaneously.
<i>GLS</i>	<i>Generalised Least-Squares Model</i> : A linear model (<i>LM</i>) allowing for the correction of heteroscedasticity (heterogeneity of variances); it might be combined with other models.
<i>LM</i>	<i>Linear Model</i> : a linear model considering only fixed effects.
<i>LME</i>	<i>Linear Mixed-Effects Model</i> : a <i>LM</i> considering fixed effects and random effects simultaneously.
<i>Month</i>	Month, in which a porpoise detection by a POD took place (factor, taking values from 1 to 12).
<i>Netto pile-driving time</i>	<i>Pile-driving phase</i> minus the duration of work intermissions, and minus the deterrence time before pile-driving activities started.
<i>Position</i>	Position at which the POD detection took place (factor, taking values from T1 to T12).
<i>Pile-driving</i>	As variable defined as a specific hour or day relative to a <i>Pile-driving phase</i> . Synonymously used: <i>Hour after pile-driving</i> , <i>Day after pile-driving</i> .
<i>Pile-driving event</i>	A period of strokes with the hydraulic hammer with a maximum break of 60 minutes between two strokes. If a break was longer than one hour, a new <i>Pile-driving event</i> started.
<i>Pile-driving day</i>	A day with an open-end <i>Pile-driving phase</i> that took place from midnight on. By this definition, only those days counted as <i>Pile-driving days</i> that were completely influenced by pile driving.
<i>Pile-driving minute</i>	A minute with pile-driving activity.
<i>Pile-driving phase</i>	Interval from the full hour in which deterrence started (starting the pinger) until the <i>End of pile-driving</i> . An intermission of more than ten hours implied the end of a <i>Pile-driving phase</i> , even when it took place at the same OWT. By this, more <i>Pile-driving phases</i> than OWTs were defined. For certain analyses the whole <i>Pile-driving phase</i> including its last whole hour was set to <i>Hour 0 after Pile-driving</i> .
<i>Pile-driving period/type</i>	see <i>Construction type/period</i> .
<i>Truncated 1st Waiting time</i>	The truncated part of a <i>1st Waiting time</i> , only spanning the time after a <i>Pile-driving event</i> .
<i>Year</i>	Year in which a harbour porpoise detection by a POD took place (factor, taking values from 2008 to 2013).

8.2 Methods

8.2.1 Windfarm construction works

Tab. 8-1: Pile-driving events for turbine foundations of OWF alpha ventus.

Foundation	Turbine	Start of piling	End of piling	Duration [min]	Strokes [n]
Tripod	AV12	24.04.2009 09:49	24.04.2009 12:47	81	2479
	AV12	24.04.2009 15:01	24.04.2009 19:59	242	7464
	AV12	24.04.2009 21:03	25.04.2009 00:21	153	4722
	AV11	01.05.2009 10:20	02.05.2009 04:22	802	25208
	AV10	18.05.2009 14:47	19.05.2009 02:28	458	15828
	AV7	21.05.2009 11:50	21.05.2009 15:33	167	6670
	AV7	21.05.2009 16:38	21.05.2009 22:58	308	10942
	AV8	24.05.2009 10:15	24.05.2009 10:47	12	432
	AV8	24.05.2009 13:05	24.05.2009 22:54	407	16490
	AV9	31.05.2009 14:18	31.05.2009 22:19	376	15994
			Tripod	Sum	3006
			Mean	300.6	10622.9
Jacket	R1	15.06.2009 02:30	15.06.2009 03:49	23	NA
	R1	16.06.2009 18:32	16.06.2009 22:05	128	1651
	R1	17.06.2009 13:51	17.06.2009 16:23	91	2184
	R1	21.06.2009 09:27	21.06.2009 11:25	26	839
	R1	21.06.2009 12:47	21.06.2009 14:56	36	789
	R1	21.06.2009 16:56	21.06.2009 17:08	12	131
	R1	21.06.2009 18:58	21.06.2009 19:00	2	50
	R1	21.06.2009 20:40	21.06.2009 20:53	13	120
	R1	27.06.2009 15:02	27.06.2009 17:00	96	2100
	R1	28.06.2009 05:37	28.06.2009 07:01	84	1700
	R1	28.06.2009 22:15	29.06.2009 00:42	80	1819
	R6	02.07.2009 12:25	02.07.2009 13:28	63	NA
	R6	03.07.2009 08:34	03.07.2009 10:04	77	1850
	R6	03.07.2009 18:39	03.07.2009 21:18	130	1850
	R6	04.07.2009 03:23	04.07.2009 04:13	50	1455
	R6	04.07.2009 10:45	05.07.2009 13:33	137	3650
	R6	05.07.2009 18:54	05.07.2009 20:36	86	2200
	R6	06.07.2009 01:06	06.07.2009 01:59	53	1508
	R6	06.07.2009 03:25	06.07.2009 04:08	43	1293
	R2	14.07.2009 05:05	14.07.2009 06:43	98	NA
	R2	14.07.2009 16:24	14.07.2009 18:13	77	2030
	R2	15.07.2009 03:06	15.07.2009 04:33	87	1950
	R2	15.07.2009 09:19	15.07.2009 09:37	18	570
	R2	15.07.2009 10:42	15.07.2009 11:06	24	585
	R2	15.07.2009 16:53	15.07.2009 18:19	52	1150
	R2	17.07.2009 05:25	17.07.2009 07:27	107	1950
	R2	17.07.2009 17:24	17.07.2009 18:57	79	2000
	R2	18.07.2009 01:48	18.07.2009 02:33	45	1204
	R2	18.07.2009 04:13	18.07.2009 04:24	11	400
	R2	18.07.2009 09:22	18.07.2009 09:52	30	738
	R3	25.07.2009 08:30	25.07.2009 08:35	5	NA
	R3	25.07.2009 20:40	25.07.2009 22:00	80	NA
	R3	26.07.2009 01:17	26.07.2009 01:40	23	NA
R3	29.07.2009 04:06	29.07.2009 06:30	144	2000	
R3	01.08.2009 19:24	01.08.2009 21:27	72	2050	
R3	02.08.2009 04:46	02.08.2009 10:26	85	2372	
R3	03.08.2009 15:05	03.08.2009 17:29	69	1900	
R3	04.08.2009 12:13	04.08.2009 14:07	60	1700	
R3	04.08.2009 17:40	04.08.2009 17:55	15	250	
R3	05.08.2009 11:49	05.08.2009 12:36	47	1320	
R3	05.08.2009 16:12	05.08.2009 16:55	43	1291	
R5	07.08.2009 05:37	07.08.2009 06:35	58	NA	
R5	08.08.2009 15:25	08.08.2009 17:07	89	2056	

Foundation	Turbine	Start of piling	End of piling	Duration [min]	Strokes [n]
	R5	08.08.2009 23:44	09.08.2009 01:18	82	1850
	R5	09.08.2009 06:17	09.08.2009 07:06	49	1164
	R5	09.08.2009 08:44	09.08.2009 09:41	57	1100
	R5	10.08.2009 13:15	10.08.2009 15:07	76	1849
	R5	10.08.2009 22:41	11.08.2009 01:22	68	900
	R5	11.08.2009 08:21	11.08.2009 08:56	35	575
	R5	11.08.2009 16:15	11.08.2009 16:37	22	529
	R5	11.08.2009 20:50	13.08.2009 22:57	61	1041
	R5	14.08.2009 00:20	14.08.2009 01:09	49	1033
	R4	19.08.2009 22:30	19.08.2009 23:38	68	NA
	R4	20.08.2009 20:34	20.08.2009 23:18	68	2480
	R4	21.08.2009 06:35	21.08.2009 07:53	49	1934
	R4	21.08.2009 10:27	21.08.2009 11:04	25	811
	R4	22.08.2009 09:20	22.08.2009 11:15	87	2924
	R4	22.08.2009 14:58	22.08.2009 16:35	41	1520
	R4	23.08.2009 13:45	23.08.2009 14:18	33	27
	R4	25.08.2009 06:43	25.08.2009 08:35	87	3700
	R4	25.08.2009 16:48	25.08.2009 18:34	99	3300
	R4	26.08.2009 00:34	26.08.2009 01:41	36	1237
	R4	26.08.2009 02:48	26.08.2009 03:52	42	1426
		Jacket	Sum	3782	82105
			Mean	60.0	1492.8

8.2.2 T-POD specifications

The software TPOD.exe (Chelonia Ltd., UK) makes T-POD data accessible. It allows defining certain criteria to filter cetacean clicks out of background sound of other sound sources (e.g., ship echolots). Within one minute a T-POD is able to perform six scans after six different criteria, each scan lasting for 9.3 seconds. The remaining 4.2 seconds are used for internal processing; no registrations take place then. The following parameters are set manually (Fig. 8-1):

1. 'A' filter:

This bandpass filter is adjusted to 130 kHz (+/-10 kHz) which is the frequency covering the main energy of harbour porpoise click sounds (Goodson & Datta 1995, Kamminga & Wiersma 1981). Only sounds within a certain range (parameter 3: 'Bandwidth') around this frequency are filtered out of other sounds.

2. 'B' filter:

This bandpass filter is set to 90 kHz, a frequency not used by harbour porpoises.

Combining both filters, sounds around 130 kHz are selected only if these at the same time are not immitted at 90 kHz. This is done against the biological backdrop that the range of the frequency spectrum of harbour porpoise click sounds is relatively small (Goodson & Datta 1995, Kamminga & Wiersma 1981), whereas sounds of other sources often cover broad-band frequency spectra. Hence, operating both filters effectively separates porpoise click sounds from disturbing noise.

v4	1	2	3	4	5	6
Scan	1	2	3	4	5	6
A kHz	130k	130k	130k	130k	130k	130k
B kHz	92k	92k	92k	92k	92k	92k
B.width	5	5	5	5	5	5
AGC	++	++	++	++	++	++
Sens	8	8	8	8	8	8
limit	240	240	240	240	240	240

Fig. 8-1: Overall scan settings used with this project by software T-POD.exe, except for parameter ‚Sens‘ which was set individually (see text). All others parameters have the default settings.

3. ‚Bandwidth‘:

This parameter sets the selectivity, hence the band width of the ‚A‘ filter frequency, to be compared with the ‚B‘ filter frequency. The higher the selectivity, the smaller is the range around the filter frequency ‚A‘ to be considered.

4. ‚AGC‘:

Reduction of background white-noise registration is operating, if this parameter is set to ‚++‘.

5. ‚Sensitivity‘:

Defines a relative threshold level that the energy of a certain sound event has to surpass for positive registration. Since individual T-PODs partly show different sensitivities, the possibility is given to adjust for such differences.

6. ‚Scanlimit‘:

Sets the limit of click registrations during a 9.3 seconds scan period. This option allows to prevent the RAM from overflow by too many other sound events (e.g., crossing vessels or waves during periods of bad weather). Limit was set to 240 clicks.

Calibration: It is advantageous for comparisons of different stations that sensitivities of individual T-PODs do not differ too much. Therefore, all devices were calibrated in a test tank prior to deployment (at Deutsches Meeresmuseum Stralsund; see also Verfuß et al. 2008). By this, a detection limit is set which a harbour porpoise click sound has to surpass for positive registration (see parameter ‚Sensitivity‘). Taking into account calibration results, threshold sound levels were set to 130 dB re 1 µPa for all T-PODs.

8.2.3 Converting T-POD data into C-POD equivalents

The model

After inspection of raw data it turned out that the most suitable variable for conversion of T-POD data into C-POD data – based on the restricted comparable dataset of eleven joint deployments (see Section 2.4.2) – was *PP10M/day*. Variables with lower (e.g., *PPD/month*), or higher (e.g., *PPM/hour*) temporal resolution provided a too biased range of detection rates for meaningful correlation of T-POD and C-POD data over a wide range of data.

Since both T-POD and C-POD data depended on a third variable, the harbour porpoise activity, a correlation procedure would have been the usual statistical choice (e.g., Pearson Product Moment or Spearman Rank Correlation). However, we were not interested in a symmetric correlation procedure here, but in a method for calculating C-POD-equivalent values out of T-POD data. This required a model based on C-POD data as dependent variable Y , and T-POD data as explanatory variable X . Inspection of an XY -plot of the available joint data (Fig. 8-2) gave strong evidence that a linear model (LM) was most suitable. Provided that the coefficient of determination R^2 was high enough (which was given: see top of Fig. 8-2), the slope of the regression line b would principally be the conversion factor of interest.

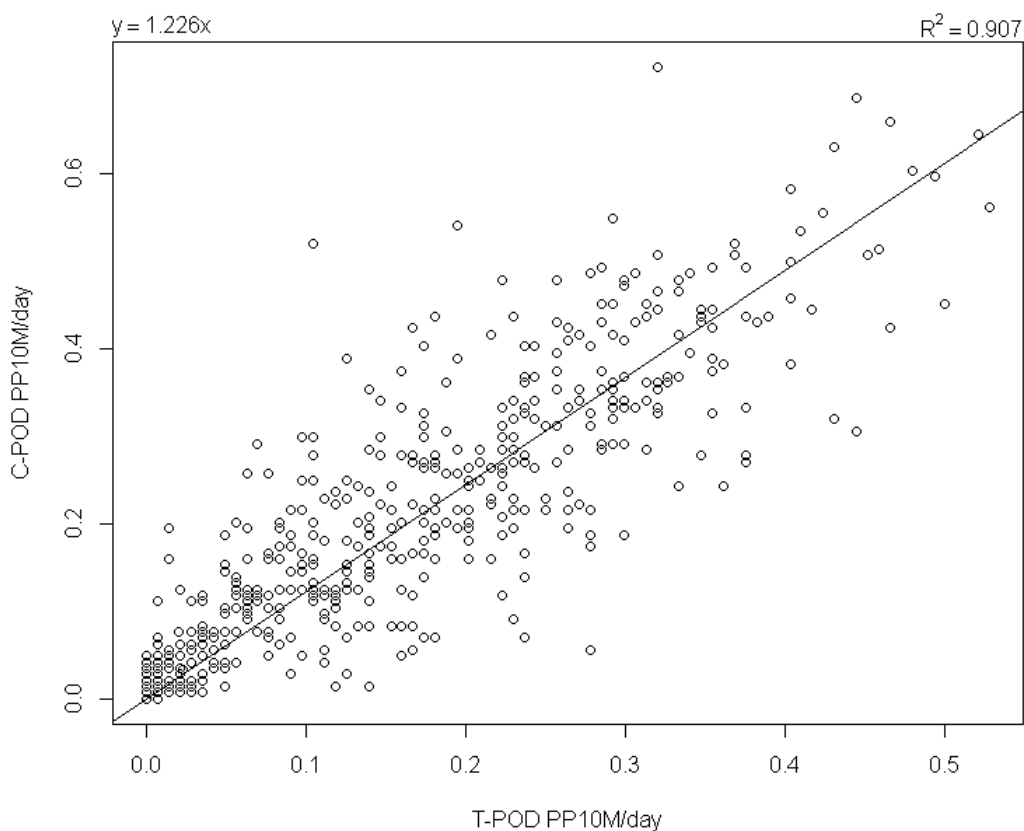

Fig. 8-2: Simple linear regression of C-POD data on T-POD data (PP10M/day) for the whole dataset (11 subsets regarding different T-POD/C-POD combinations; $N = 527$).

However, a simple linear model (Fig. 8-2) turned out to be inadequate here since normality was not given (Fig. 8-3, upper right panel), and – as a more serious item – the required equality of variances (homoscedasticity) was violated as well (Fig. 8-3, upper left panel).

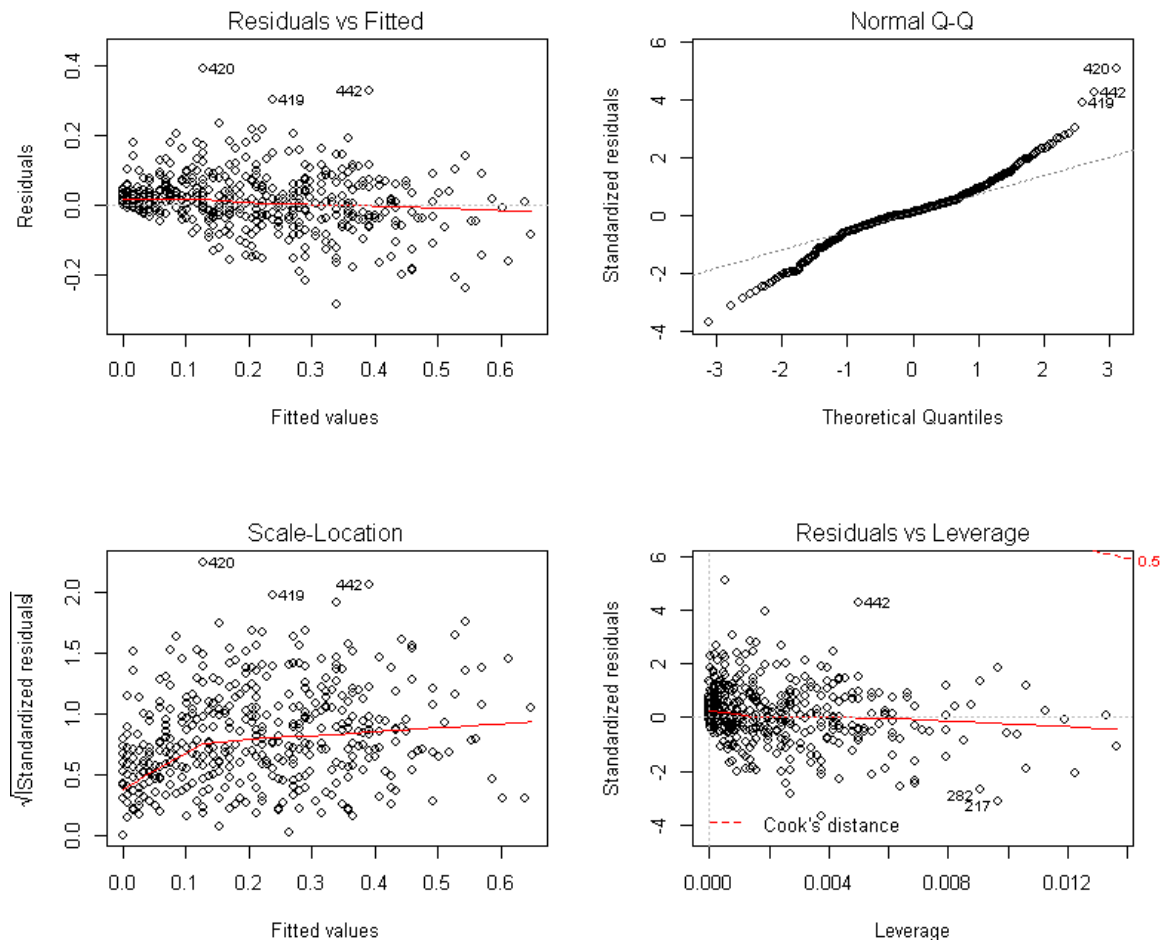

Fig. 8-3: Residuals plots for a simple linear model (LM) with all data (11 subsets regarding different T-POD/C-POD combinations; $N = 527$).

Furthermore, considerable variability between the regression slopes for different combinations of T-PODs and C-PODs occurred (Tab. 8-2). Since all other factors were kept constant, this could have been caused by differing operational qualities of the PODs, or to inaccuracies due to the restricted data range of some data subsets. Indeed, three out of four data subsets from 2010 (Tab. 8-2, first three combinations in column *tc_comb*) were quite restricted in their range (Fig. 8-4). Furthermore, the normality assumption was violated for these three subsets, though the assumption held true for most of the other eight subsets (Tab. 8-3). The difference between the average slope per subset (*Avg.comb* = 1.484; Tab. 8-2) and the overall value (*Simple LM* = 1.226) gave further indication of a remarkable inter-subset variability, especially influenced by the first two data subsets.

Hence, data from POD combinations "618_772", "479_774", and "494_762" were excluded from further analyses. Even though the normality assumption was violated with combination "450_757" (Tab. 8-3), it was kept included due to its balanced range of data.

Tab. 8-2: Parameters of simple linear regressions with each of 11 data subsets (*tc_comb* = T-POD/C-POD combination; range: + = balanced data range, - = biased data range (zero-inflated); Estimate = slope of the regression line; rel. factor = inverse relation of a subset Estimate to slope *b* of the overall-linear-model regression line ('Overall LM': $b = 1.22597$): e.g., 40.1% would be the proportion of a C-POD value estimated by subset 618_772 in relation to a mean estimated value based on all data; relative over-/underestimation by data of a subset: in percentage and +/- (one sign stands for 10%); minimum, maximum and median Estimates are indicated; Avg.comb = arithm. mean of Estimates and rel. factor).

tc_comb	range	year	Estimate	Std.Error	rel. factor	over-/underestimation		
618_772	-	2010	3.05790	0.21460	40.1%	-59.9%	-----	min
479_774	-	2010	1.82220	0.12230	67.3%	-32.7%	----	
494_762	-	2010	1.18040	0.11620	103.9%	3.9%	+	
450_757	+	2010	1.42050	0.05191	86.3%	-13.7%	--	
498_700	+	2013	1.12225	0.03822	109.2%	9.2%	+	
478_772	+	2013	1.04686	0.04226	117.1%	17.1%	++	
450_1040	+	2013	1.02660	0.03640	119.4%	19.4%	++	max
479_1117	+	2013	1.26067	0.03358	97.2%	-2.8%	-	median
494_1043	+	2013	1.63300	0.11100	75.1%	-24.9%	---	
627_763	+	2013	1.58212	0.06974	77.5%	-22.5%	---	
480_1121	+	2013	1.17498	0.03976	104.3%	4.3%	+	
			1.22597	Overall LM				
			1.48432	Avg.comb	90.7%			

Tab. 8-3: Shapiro-Wilks normality tests for all 22 single POD datasets out of 11 POD-combination subsets (*tc_comb* = T-POD/C-POD combination, bold: eight subsets chosen for further analyses; T-POD resp. C-POD = ID of a POD; *W* = test statistics; *p* value and sign. = probability of normality and significance after Bonferroni correction).

tc_comb	T-POD	W	p value	sign.	C-POD	W	p value	sign.
618_772	618	0.657	0.000000	***	772	0.783	0.000004	***
479_774	479	0.844	0.000031	***	774	0.860	0.000080	**
494_762	494	0.755	0.000000	***	762	0.823	0.000009	***
450_757	450	0.860	0.000078	**	757	0.883	0.000337	**
498_700	498	0.943	0.051990		700	0.954	0.118900	
478_772	478	0.963	0.064820		772	0.967	0.100200	
450_1040	450	0.978	0.235400		1040	0.944	0.002673	
479_1117	479	0.967	0.106400		1117	0.960	0.049030	
494_1043	494	0.971	0.500800		1043	0.946	0.098460	
627_763	627	0.928	0.007973		763	0.970	0.290200	
480_1121	480	0.971	0.303600		1121	0.973	0.359800	

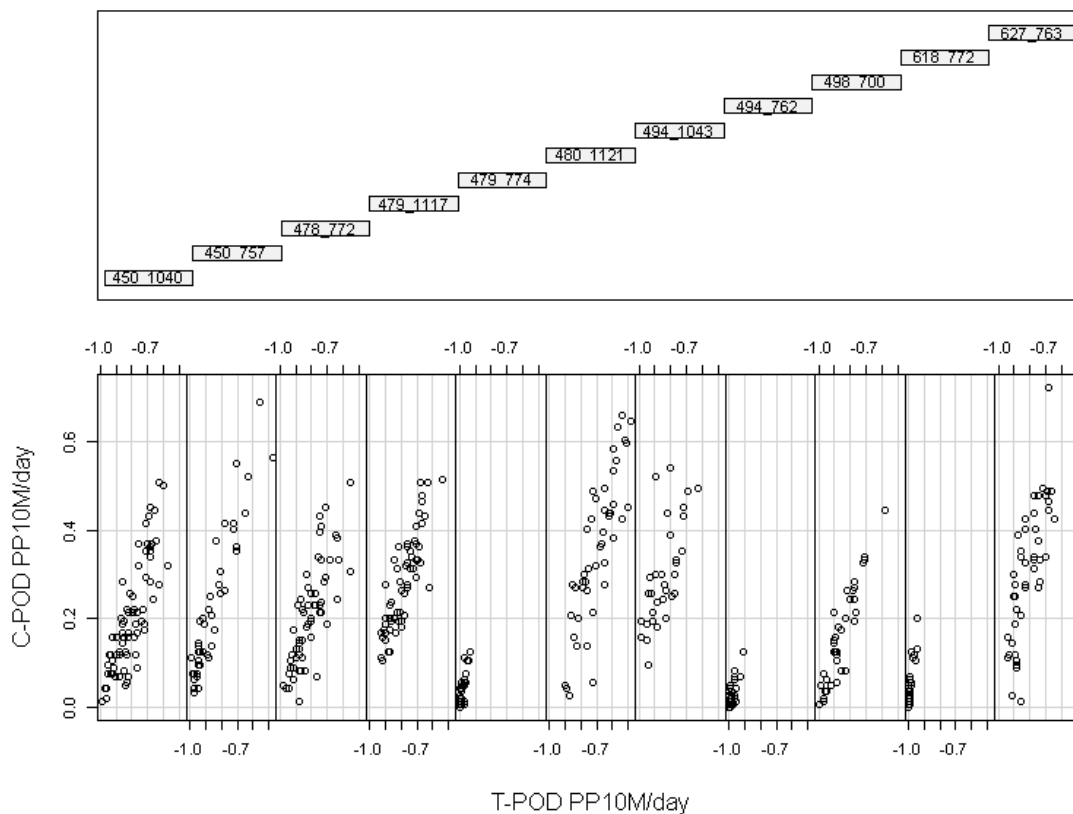

Fig. 8-4: Dot plots for 11 data subsets, each representing a T-POD/C-POD combination; for combinations “618_772”, “479_774”, and “494_762” the detection rates were always low, rendering these subsets unsuitable for assessment of a T-POD/C-POD conversion factor.

Since a simple linear model (LM) was not suitable for the dataset, a linear mixed-effects model (LME) was chosen. An LME model allowed inclusion of random effects into the model structure. A special form of LME models, a random-slope model (Zuur et al. 2009), was applied to the reduced dataset consisting of the remaining eight data subsets (Tab. 8-3). By this kind of model it was possible to correct for differing slopes of regression lines for different POD combinations, which was shown to be the case (Tab. 8-2). Furthermore, a VarIdent structure was included into this baseline model (eight POD combinations, $N = 400$), in order to correct for heteroscedasticity of data according to differing variances of the eight data subsets. This resulted in a GLS model as a special variant of an LME random-slope model.

The slope of the regression line resulting from the LME (GLS) random-slope model ($b = 1.2724$, Fig. 8-5) was the desired conversion factor for T-POD data into C-POD equivalent values. It was slightly higher than the factor b from the simple linear model (Fig. 8-2). In order to account for data variation, 95% confidence intervals for the slope were calculated by the model ($1.115 < b < 1.430$); these, however, were the b mean value and confidence intervals for $N_{total} = 400$ (all data), which was regarded as our baseline distribution. For comparing any T-POD data with C-POD data, we had to correct the model by permutation of subsamples of size N_{sample} taken from the baseline distribution ($N_{sample} =$ size of the T-POD dataset of interest), with subsequent averaging of b and its 95% confidence intervals. This adjusted confidence levels according to the T-POD sample size

(Fig. 8-6). Inclusion of the VarIdent structure into subsample models turned out not to be meaningful below $N_{sample} = 80$, due to low partial N of some POD-combinations.

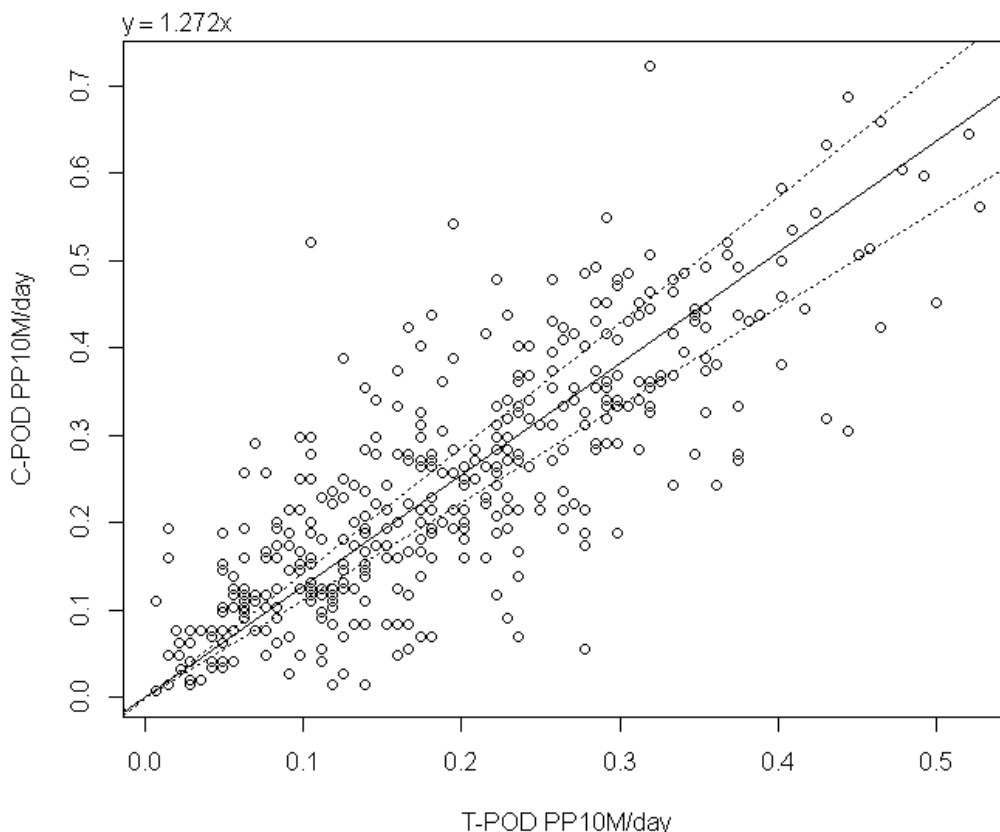

Fig. 8-5: LME modeling of C-POD data on T-POD data (PP10M/day) with the reduced dataset (see Tab. 8-4: eight subsets regarding different T-POD/C-POD combinations; $N_{total} = 400$: baseline distribution with LME regression line and CI envelope).

Tab. 8-4: Parameters of simple linear regressions with each of the remaining eight data subsets (legend: see Tab. 8-2), compared to the Estimate of the overall LME model ('Overall LME').

tc_comb	range	year	Estimate	Std.Error	rel. factor	over/underestimation		
450_757	+	2010	1.42050	0.05191	89.6%	-10.4%	--	
498_700	+	2013	1.12225	0.03822	113.4%	13.4%	+	
478_772	+	2013	1.04686	0.04226	121.5%	21.5%	++	
450_1040	+	2013	1.02660	0.03640	123.9%	23.9%	++	max
479_1117	+	2013	1.26067	0.03358	100.9%	0.9%	-	median
494_1043	+	2013	1.63300	0.11100	77.9%	-22.1%	---	min
627_763	+	2013	1.58212	0.06974	80.4%	-19.6%	---	
480_1121	+	2013	1.17498	0.03976	108.3%	8.3%	+	
			1.27244	Overall LME				
			1.28337	Avg.comb	102.0%			

The negligible difference between the average slope per subset ($Avg.comb = 1.283$; Tab. 8-4) and the overall value ($Overall LME = 1.272$; Tab. 8-4) gave evidence for the much better suitability of the *LME* model. Based on data of single subsets, the assessed C-POD values would be over-/underestimated by 15.0% on average (maximum: 22.1% overestimation and 23.9% underestimation; Tab. 8-4). One should be aware of the variability of *b* values of up to 25%; however, confidence intervals for the slope of the overall model ($\pm 12.4\%$) amounted to just half of the inter-subset variability of the model for the baseline dataset ($N_{total} = 400$).

In summary, the *LME (GLS)* random-slope model was much more suitable for the conversion of T-POD data into C-POD equivalents than a simple linear regression model. Since the *LME* model treated the chosen data subsets of POD combinations as a random selection taken from the population of POD combinations, the conversion factor was applicable to other POD combinations, which was essential for further analyses. However, the model always had to be adapted to the respective subsample size N_{sample} .

Confidence intervals

In addition to the mean calculated by the random-slope model, $D_{Bi,mean}$, the adjusted 95%-confidence levels, $D_{Bi,L95}$ and $D_{Bi,U95}$, were computed. This was done by a permutation procedure (1,000 subset permutations with N_{sample} data). Confidence intervals were not definable for comparisons of phenologies ($PP10M/day$) on a daily base (single days: $N_{sample} = 1$). At this temporal resolution, analyses of phenologies had to be kept on a strictly explorative level. Lower confidence intervals surpassed zero when phenologies were smoothed over at least seven days per curve point ($N_{sample} = 7$, see Fig. 8-6). Hence, comparisons did not make sense with T-POD subsample sizes of $N_{sample} < 7$. Comparisons started to make sense for $N_{sample} \geq 10$.

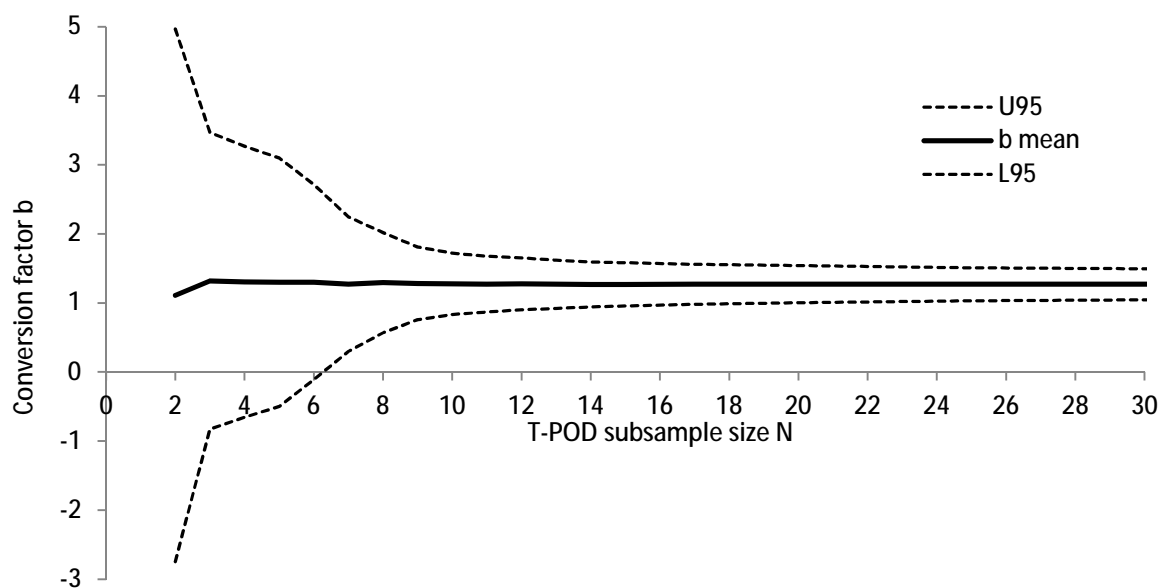

Fig. 8-6: Dependence of the 95% confidence envelope of conversion factor *b* on subsample size N_{sample} (envelopes are based on 1,000 permutations of N_{sample} data randomly drawn from the baseline dataset with $N_{total} = 400$ pairs of T-POD and C-POD data).

8.3 Results

8.3.1 Aerial surveys

Harbour porpoise and seal observations

Tab. 8-5: Number of harbour porpoise individuals observed during 47 aerial marine mammal transect surveys (183 m) from March 2008 to March 2013; also given: number of sightings, valid transect range, individuals per valid transect km, average group size, number and proportion of calves (only valid sightings of the main observers at valid transect parts were included); flights on days with pile-drivings in red.

Date	Valid km	Ind.	Sightings	Ind./km	Group size	Calves (ind.)	Calves (%)
15.03.2008	516	33	33	0.03	1	0	0
08.04.2008	462	73	64	0.07	1.14	0	0
06.05.2008	448	121	116	0.13	1.04	0	0
15.05.2008	455	29	27	0.03	1.07	0	0
24.07.2008	220	3	3	0.02	1	0	0
Phase I: Sum/Avg	2100	259	243	0.06	1.05	0	0.0
17.09.2008	522	43	29	0.07	1.48	0	0
18.09.2008	250	33	20	0.1	1.65	4	12.1
09.10.2008	442	24	14	0.04	1.71	0	0
13.04.2009	489	94	85	0.21	1.11	0	0
23.04.2009	518	172	169	0.39	1.02	0	0
08.06.2009	482	23	17	0.04	1.35	5	21.7
29.06.2009	322	37	30	0.11	1.23	3	8.1
14.07.2009	520	36	29	0.07	1.24	2	5.6
26.07.2009	314	11	10	0.04	1.1	1	9.1
03.08.2009	521	28	23	0.05	1.22	1	3.6
22.08.2009	335	16	9	0.03	1.78	4	25
18.09.2009	493	9	8	0.02	1.13	0	0
Phase II: Sum/Avg	5207	526	443	0.10	1.34	20	7.1
09.02.2010	415	1	1	0.00	1.00	0	0
21.03.2010	318	30	28	0.09	1.07	0	0
04.04.2010	521	15	15	0.03	1.00	0	0
05.05.2010	441	30	28	0.07	1.07	0	0
26.05.2010	447	35	29	0.08	1.21	6	17.1
04.06.2010	471	24	16	0.05	1.50	2	8.3
23.06.2010	519	96	80	0.18	1.20	8	8.3
20.07.2010	513	79	52	0.15	1.52	15	19.0
12.08.2010	520	41	37	0.08	1.11	4	9.8
21.09.2010	520	69	63	0.13	1.10	2	2.9
12.10.2010	372	5	3	0.01	1.67	0	0
Phase III-1: Sum/Avg	5057	425	352	0.08	1.22	37	6.0
13.03.2011	521	17	14	0.03	1.21	0	0
15.04.2011	310	39	39	0.13	1.00	0	0
20.04.2011	521	84	69	0.16	1.22	2	2.4
06.05.2011	493	67	66	0.14	1.02	0	0
02.06.2011	518	92	76	0.18	1.21	10	10.9
05.07.2011	505	52	44	0.10	1.18	6	11.5
27.07.2011	444	17	13	0.04	1.31	3	17.7
22.08.2011	507	60	48	0.12	1.25	6	10.0
16.09.2011	461	27	27	0.06	1.00	0	0
Phase III-2: Sum/Avg	4280	455	396	0.11	1.16	27	5.8
16.01.2012	468	19	13	0.04	1.46	0	0
14.03.2012	521	38	31	0.07	1.23	0	0
15.03.2012	454	47	46	0.10	1.02	0	0
22.03.2012	520	124	107	0.24	1.16	0	0
23.03.2012	475	111	101	0.23	1.10	0	0
31.05.2012	521	163	118	0.31	1.38	14	8.6
03.07.2012	351	5	5	0.01	1.00	0	0
11.08.2012	307	20	18	0.07	1.11	1	5.0
30.11.2012	521	70	47	0.13	1.49	0	0
06.03.2013	455	21	16	0.05	1.31	0	0
Phase III-3: Sum/Avg	4592	618	502	0.13	1.23	15	1.4
Phase III: Sum/Avg	13929	1498	1250	0.10	1.20	79	4.4
Total: Sum/Avg	21235	2283	1936	0.09	1.19	99	4.6

Tab. 8-6: Number of harbour porpoise individuals observed during 49 combined marine mammal/bird survey flights (76 m) from March 2008 to March 2013; also given: number of sightings, valid transect range, relative abundance per valid transect km, average group size, number and proportion of calves (only valid sightings of the main observers at valid transect parts were included); flights on days with pile-drivings in red.

Date	Valid km	Ind.	Sightings	Ind./km	Group size	Calves (ind.)	Calves (%)
16.02.2008	474	39	33	0.035	1.18	0	0
27.03.2008	460	63	60	0.065	1.05	0	0
31.03.2008	494	57	45	0.046	1.27	0	0
10.04.2008	475	38	36	0.038	1.06	0	0
17.04.2008	420	35	35	0.042	1	0	0
02.05.2008	477	81	77	0.081	1.05	0	0
09.05.2008	497	50	47	0.047	1.06	0	0
04.06.2008	521	61	48	0.046	1.27	5	8.2
03.07.2008	521	31	25	0.057	1.24	6	19.4
Phase I: Sum/Avg	4339	455	406	0.05	1.13	11	3.1
15.08.2008	508	19	17	0.04	1.11	0	0
20.03.2009	522	35	29	0.066	1.21	0	0
21.04.2009	519	26	26	0.06	1	0	0
19.05.2009	489	31	22	0.053	1.41	0	0
17.06./03.07.2009	474	11	9	0.023	1.22	1	9.1
05.08.2009	387	10	10	0.031	1	0	0
19.09.2009	520	4	3	0.007	1.33	0	0
27.10.2009	520	13	11	0.025	1.18	1	7.7
10.11.2009	514	9	7	0.016	1.29	0	0
08.12.2009	475	32	27	0.068	1.19	1	3.1
Phase II: Sum/Avg	4927	190	161	0.04	1.19	3	2.0
07.03.2010	519	28	25	0.05	1.12	0	0
23.03.2010	509	46	37	0.09	1.24	0	0
15./19.04.2010	469	20	20	0.04	1.00	0	0
09.05.2010	441	8	8	0.02	1.00	0	0
05.06.2010	505	50	33	0.10	1.52	11	22.0
24.06.2010	504	73	55	0.14	1.33	8	11.0
09.07.2010	491	19	15	0.04	1.27	2	10.5
27.07.2010	494	50	42	0.10	1.19	4	8.0
07.10.2010	520	4	3	0.01	1.33	2	50.0
16.11.2010	495	19	17	0.04	1.12	0	0
Phase III-1: Sum/Avg	4947	317	255	0.06	1.21	27	10.1
28.01.2011	414	1	1	0.00	1.00	0	0
13.03.2011	520	30	25	0.06	1.20	0	0
11.04.2011	502	106	93	0.21	1.14	0	0
05.05.2011	511	132	124	0.26	1.06	1	0.8
20.05.2011	520	72	68	0.14	1.06	0	0
07.06.2011	500	51	41	0.10	1.24	6	11.8
20.07.2011	506	34	29	0.07	1.17	4	11.8
18.08.2011	519	32	24	0.06	1.33	4	12.5
01.09.2011	516	15	12	0.03	1.25	2	13.3
25.09.2011	521	30	22	0.06	1.36	0	0
Phase III-2: Sum/Avg	5029	503	439	0.10	1.18	17	5.0
15.01.2012	425	21	18	0.05	1.17	0	0
06.03.2012	507	11	10	0.02	1.10	0	0
08.04.2012	452	55	52	0.12	1.06	0	0
20.04.2012	521	68	68	0.13	1.00	0	0
14.06.2012	476	9	8	0.02	1.13	1	11.1
07.07.2012	508	43	34	0.08	1.26	4	9.3
15.11.2012	248	41	36	0.17	1.14	0	0
24.01.2013	514	13	13	0.03	1.00	0	0
13.02.2013	504	13	11	0.03	1.18	0	0
27.02.2013	344	10	10	0.03	1.00	0	0
Phase III-3: Sum/Avg	4499	284	260	0.07	1.10	5	2.0
Phase III: Sum/Avg	14475	1104	954	0.08	1.17	49	5.7
Total: Sum/Avg	23741	1749	1521	0.06	1.14	63	4.4

Tab. 8-7: Seal observations during marine mammal survey flights (183 m; valid sightings of the main observers, here identical to numbers of individuals; survey days with pile driving in red).

Phase	Date	Harbour seal	Grey seal	Seal indet.
Phase I (2008)	15.03.2008	2	3	
	08.04.2008	4	2	1
	06.05.2008	1	1	
	15.05.2008	1		
	24.07.2008			
	Phase I: Sum		8	6
Phase II (2008/09)	17.09.2008	1		
	18.09.2008	1		
	09.10.2008	2		
	13.04.2009			
	23.04.2009			
	08.06.2009			
	29.06.2009		1	1
	14.07.2009	1		
	26.07.2009			
	03.08.2009			
	22.08.2009			
18.09.2009				
Phase II: Sum		5	1	1
Phase III-1 (2010)	09.02.2010	1		
	21.03.2010	4		
	04.04.2010			
	05.05.2010			
	26.05.2010		4	
	04.06.2010	2		1
	23.06.2010	2	6	2
	20.07.2010			2
	12.08.2010			2
	21.09.2010	2		4
	12.10.2010	1		
Phase III-1: Sum		12	10	11
Phase III-2 (2011)	13.03.2011	3		1
	15.04.2011		2	1
	20.04.2011	14		
	06.05.2011	1		1
	02.06.2011	4	1	
	05.07.2011		1	
	27.07.2011		1	1
	22.08.2011	2		1
	16.09.2011	5	1	
Phase III-2: Sum		24	5	5
Phase III-3 (2012/13)	16.01.2012	4	1	
	14.03.2012	4		2
	15.03.2012	11		
	22.03.2012	24		1
	23.03.2012	21		
	31.05.2012	4	1	
	03.07.2012			
	11.08.2012	1		
	30.11.2012	4	2	4
	06.03.2013			1
Phase III-3: Sum		73	4	8
Phase III: Sum		109	19	24
Total: Sum		122	26	26

Tab. 8-8: Seal observations during combined marine mammal/bird survey flights (76 m; valid sightings of main observers, here identical to numbers of individuals; days with pile driving in red).

Phase	Date	Harbour seal	Grey seal	Seal indet.
Phase I (2008)	16.02.2008	4	3	
	27.03.2008	3		
	31.03.2008	4		
	10.04.2008		1	
	17.04.2008	5		
	02.05.2008			
	09.05.2008	1		
	04.06.2008		1	
	03.07.2008	1		
	Phase I: Sum		18	4
Phase II (2008/09)	15.08.2008			
	20.03.2009			
	21.04.2009	1		
	19.05.2009			
	17.06./03.07.2009	1		
	05.08.2009			
	19.09.2009	1		
	27.10.2009	2		1
	10.11.2009			
	08.12.2009	2		
Phase II: Sum		7	0	1
Phase III-1 (2010)	07.03.2010	8		
	23.03.2010	1	2	
	15./19.04.2010		1	
	09.05.2010			
	05.06.2010	1		
	24.06.2010	4	11	2
	09.07.2010	3		
	27.07.2010	6	2	3
	07.10.2010			
	16.11.2010	1		1
Phase III-1: Sum		24	16	6
Phase III-2 (2011)	28.01.2011	2	1	1
	13.03.2011	5		
	11.04.2011	3		2
	05.05.2011	4	1	3
	20.05.2011	5	2	1
	07.06.2011	15		1
	20.07.2011	3		1
	18.08.2011		1	1
	01.09.2011	2		
	25.09.2011	3	1	
Phase III-2: Sum		42	6	10
Phase III-3 (2012/13)	15.01.2012	3	6	1
	06.03.2012	4		
	08.04.2012	6		
	20.04.2012	2	2	
	14.06.2012			
	07.07.2012	6		
	15.11.2012	1	1	1
	24.01.2013	5	1	3
	13.02.2013	1	1	
	27.02.2013	1	1	1
Phase III-3: Sum		29	12	6
Phase III: Sum		95	34	22
Total: Sum		120	38	23

Harbour porpoise densities

Tab. 8-9: Harbour porpoise stock and densities in the project area (aerial marine mammal transect surveys from March 2008 to March 2013; 183 m); also given: correction factor $g(0)$ and one-sided ESW (Effective Strip Width; * = cumulative value); only valid sightings of the main observers at valid transect parts were included; flights on days with pile-drivings in red.

Date	$g(0)$	One-sided ESW after software Distance (m)*	Density (ind./ km ²)	Project area (km ²)	Stock in project area (ind.)		
15.03.2008	0.30	198.44	0.53	2048	1086		
08.04.2008	0.38		1.05		2151		
06.05.2008	0.31		2.19		4491		
15.05.2008	0.31		0.52		1060		
24.07.2008	0.31		0.11		225		
Phase I: Avg	0.32		0.88		1803		
17.09.2008	0.30	198.44	0.70	2048	1425		
18.09.2008	0.30		1.12		2287		
09.10.2008	0.34		0.41		832		
13.04.2009	0.42		1.15		2358		
23.04.2009	0.42		1.99		4077		
08.06.2009	0.30		0.40		826		
29.06.2009	0.30		0.97		1990		
14.07.2009	0.31		0.56		1139		
26.07.2009	0.31		0.28		576		
03.08.2009	0.30		0.45		930		
22.08.2009	0.30		0.40		827		
18.09.2009	0.30	0.15	316				
Phase II: Avg	0.33		0.72		1465		
09.02.2010	0.34	185.28	0.02	2048	39		
21.03.2010	0.34		0.74		1521		
04.04.2010	0.43		0.18		372		
05.05.2010	0.35		0.52		1073		
26.05.2010	0.35		0.60		1236		
04.06.2010	0.30		0.45		928		
23.06.2010	0.30		1.64		3364		
20.07.2010	0.32		1.30		2664		
12.08.2010	0.30		0.70		1435		
21.09.2010	0.30		1.18		2415		
12.10.2010	0.34		0.11		217		
Phase III-1: Avg	0.33				0.68		1388
13.03.2011	0.41		185.28		0.21	2048	439
15.04.2011	0.33	1.04		2121			
20.04.2011	0.33	1.33		2714			
06.05.2011	0.34	1.09		2236			
02.06.2011	0.29	1.65		3373			
05.07.2011	0.31	0.91		1861			
27.07.2011	0.31	0.34		692			
22.08.2011	0.33	0.97		1990			
16.09.2011	0.29	0.54		1112			
Phase III-2: Avg	0.33		0.90		1838		
16.01.2012	0.34	185.28	0.32	2048	655		
14.03.2012	0.43		0.46		942		
15.03.2012	0.43		0.65		1336		
22.03.2012	0.43		1.50		3074		
23.03.2012	0.43		1.47		3017		
31.05.2012	0.35		2.41		4937		
03.07.2012	0.32		0.12		246		
11.08.2012	0.34		0.51		1052		
30.11.2012	0.34		1.06		2167		
06.03.2013	0.43		0.29		595		
Phase III-3: Avg	0.38		0.88		1802		
Phase III: Avg	0.35		0.81		1661		
Total: Avg	0.33		0.78		1588		

Tab. 8-10: Harbour porpoise stock and densities in the project area (combined marine mammal/bird aerial surveys; 76 m; see Tab. 8-9 for explanations).

Date	g(0)	One-sided ESW after software Distance (m)*	Density (ind./ km ²)	Project area (km ²)	Stock in project area (ind.)
16.02.2008	0.30	103.72	1.31	2048	2673
27.03.2008	0.30		2.17		4450
31.03.2008	0.30		1.83		3751
10.04.2008	0.38		1.02		2080
17.04.2008	0.38		1.06		2170
02.05.2008	0.31		2.64		5400
09.05.2008	0.31		1.56		3198
04.06.2008	0.27		2.10		4297
03.07.2008	0.24		1.20		2448
Phase I: Avg	0.31				1.65
15.08.2008	0.23	103.72	0.79	2048	1617
20.03.2009	0.26		1.26		2571
21.04.2009	0.32		0.75		1536
19.05.2009	0.26		1.16		2377
17.06./03.07.2009	0.23		0.49		1004
05.08.2009	0.23		0.55		1116
19.09.2009	0.23		0.16		333
27.10.2009	0.26		0.47		958
10.11.2009	0.26		0.33		672
08.12.2009	0.26		1.26		2583
Phase II: Avg	0.25		0.72		1477
07.03.2010	0.34	101.47	0.79	2048	1614
23.03.2010	0.34		1.32		2706
15./19.04.2010	0.42		0.50		1020
09.05.2010	0.34		0.26		531
05.06.2010	0.30		1.63		3344
24.06.2010	0.30		2.39		4892
09.07.2010	0.31		0.61		1244
27.07.2010	0.31		1.59		3250
07.10.2010	0.34		0.11		230
16.11.2010	0.34		0.56		1150
Phase III-1: Avg	0.33		0.98		1998
28.01.2011	0.40	101.47	0.03	2048	62
13.03.2011	0.49		0.58		1178
11.04.2011	0.40		2.63		5388
05.05.2011	0.40		3.15		6447
20.05.2011	0.40		1.69		3458
07.06.2011	0.35		1.43		2937
20.07.2011	0.37		0.90		1839
18.08.2011	0.40		0.77		1575
01.09.2011	0.35		0.41		837
25.09.2011	0.35		0.81		1660
Phase III-2: Avg	0.39		1.24		2538
15.01.2012	0.33	101.47	0.73	2048	1501
06.03.2012	0.42		0.26		527
08.04.2012	0.33		1.80		3694
20.04.2012	0.33		1.93		3963
14.06.2012	0.29		0.32		647
07.07.2012	0.31		1.35		2756
15.11.2012	0.33		2.45		5010
24.01.2013	0.33		0.37		768
13.02.2013	0.33		0.38		783
27.02.2013	0.33		0.43		883
Phase III-3: Avg	0.33		1.00		2053
Phase III: Avg	0.35		1.07		2197
Total: Avg	0.33		1.11		1999

8.3.2 Vessel-based surveys

Harbour porpoise and seal observations

Tab. 8-11: Overview of harbour porpoise groups (sighting events) and individuals counted during vessel-based transect surveys in subareas 'Vessel West' and 'Vessel East' (AGS: average group size).

Date	Harbour porpoise								
	Vessel West			Vessel East			Total		
	Ind.	Groups	AGS	Ind.	Groups	AGS	Ind.	Groups	AGS
11.02.2008	88	49	1.80	19	8	2.38	107	57	1.88
15.03.2008	12	6	2.00				12	6	2.00
05.04.2008	4	3	1.33	7	3	2.33	11	6	1.83
11.04.2008				3	1	3.00	3	1	3.00
17.04.2008	3	2	1.50	2	1	2.00	5	3	1.67
12.05.2008				1	1	1.00	1	1	1.00
23.07.2008	1	1	1.00	2	2	1.00	3	3	1.00
Phase I: Sum	108	61	1.77	34	16	2.13	142	77	1.84
01.04.2009				5	4	1.25	5	4	1.25
12.04.2009	1	1	1.00	5	2	2.50	6	3	2.00
23.04.2009	13	6	2.17				13	6	2.17
07.06.2009				1	1	1.00	1	1	1.00
15.07.2009	1	1	1.00				1	1	1.00
03.08.2009	2	2	1.00	1	1	1.00	3	3	1.00
18.09.2009	2	1	2.00				2	1	2.00
26.09.2009	3	2	1.50				3	2	1.50
11.10.2009	12	6	2.00				12	6	2.00
18.10.2009	3	2	1.50	5	3	1.67	8	5	1.60
30.10.2009	2	2	1.00	3	3	1.00	5	5	1.00
10./11.11.2009	1	1	1.00				1	1	1.00
10./11.12.2009	1	1	1.00	1	1	1.00	2	2	1.00
Phase II: Sum	41	25	1.64	21	15	1.40	62	40	1.55
04./05.01.2010	4	2	2.00	4	2	2.00	8	4	2.00
06./07.02.2010	1	1	1.00				1	1	1.00
22./25.02.2010				1	1	1.00	1	1	1.00
10.03.2010	9	9	1.00	2	2	1.00	11	11	1.00
23.03.2010	2	2	1.00	6	4	1.50	8	6	1.33
30.03.2010	1	1	1.00				1	1	1.00
07.04.2010				2	2	1.00	2	2	1.00
25.04.2010				2	2	1.00	2	2	1.00
09.05.2010	1	1	1.00	1	1	1.00	2	2	1.00
26.05.2010	1	1	1.00				1	1	1.00
08.06.2010	5	2	2.50	3	2	1.50	8	4	2.00
04.07.2010	6	5	1.20	7	4	1.75	13	9	1.44
01.08.2010	55	41	1.34	1	1	1.00	56	42	1.33
17.08.2010	14	7	2.00				14	7	2.00
04.09.2010	4	2	2.00				4	2	2.00
21.09.2010	35	26	1.35				35	26	1.35
31.10./01.11.2010	22	11	2.00	1	1	1.00	23	12	1.92
19./20.11.2010	38	25	1.52	6	5	1.20	44	30	1.47
27./28.11.2010	1	1	1.00				1	1	1.00
20./21.12.2010	7	6	1.17	1	1	1.00	8	7	1.14
Phase III-1: Sum	206	143	1.44	37	28	1.32	243	171	1.42
20./21.01.2011				2	2	1.00	2	2	1.00
28./29.01.2011	7	5	1.40	1	1	1.00	8	6	1.33
13./15.02.2011	7	6	1.17				7	6	1.17
02.03.2011	7	6	1.17				7	6	1.17
13.03.2011	3	3	1.00	9	7	1.29	12	10	1.20
27./28.03.2011	19	9	2.11	23	17	1.35	42	26	1.62
05./10.04.2011	2	2	1.00	2	2	1.00	4	4	1.00
17./18.04.2011	2	1	2.00	2	2	1.00	4	3	1.33
07.05.2011	1	1	1.00				1	1	1.00
21.05.2011	3	2	1.50	21	18	1.17	24	20	1.20
31.05.2011	10	4	2.50	6	3	2.00	16	7	2.29

Date	Harbour porpoise								
	Vessel West			Vessel East			Total		
	Ind.	Groups	AGS	Ind.	Groups	AGS	Ind.	Groups	AGS
09.06.2011	4	3	1.33				4	3	1.33
13.08.2011	2	2	1.00	1	1	1.00	3	3	1.00
22.08.2011	20	11	1.82				20	11	1.82
16.09.2011	7	6	1.17	4	4	1.00	11	10	1.10
25.09.2011	10	8	1.25				10	8	1.25
01.10.2011	44	26	1.69	4	3	1.33	48	29	1.66
16.10.2011	1	1	1.00				1	1	1.00
28.10.2011	2	1	2.00				2	1	2.00
22./23.12.2011	28	21	1.33	7	5	1.40	35	26	1.35
Phase III-2: Sum	179	118	1.52	82	65	1.26	261	183	1.43
28./29.01.2012	2	1	2.00				2	1	2.00
27.02.2012	5	4	1.25	2	2	1.00	7	6	1.17
06.03.2012	8	6	1.33	2	1	2.00	10	7	1.43
18.03.2012				1	1	1.00	1	1	1.00
27.03.2012	2	2	1.00	1	1	1.00	3	3	1.00
05.04.2012				3	1	3.00	3	1	3.00
14.04.2012	12	5	2.40	3	2	1.50	15	7	2.14
23.04.2012				9	8	1.13	9	8	1.13
07.05.2012	1	1	1.00	11	8	1.38	12	9	1.33
30.05.2012	5	4	1.25	25	18	1.39	30	22	1.36
08.06.2012				1	1	1.00	1	1	1.00
26.07.2012	3	2	1.50				3	2	1.50
05.08.2012	45	26	1.73				45	26	1.73
21.08.2012	28	17	1.65				28	17	1.65
03.09.2012	12	6	2.00	2	1	2.00	14	7	2.00
11.10.2012	3	3	1.00	5	4	1.25	8	7	1.14
18.10.2012	1	1	1.00	1	1	1.00	2	2	1.00
24.10.2012	9	4	2.25	1	1	1.00	10	5	2.00
05./06.11.2012	3	3	1.00	2	1	2.00	5	4	1.25
14./15.11.2012	44	22	2.00	4	3	1.33	48	25	1.92
24.11.2012	1	1	1.00				1	1	1.00
16./17.12.2012	10	8	1.25				10	8	1.25
05./06.01.2013	8	4	2.00				8	4	2.00
09./10.02.2013				4	4	1.00	4	4	1.00
05.03.2013	1	1	1.00	1	1	1.00	2	2	1.00
13.03.2013				1	1	1.00	1	1	1.00
29.03.2013	2	2	1.00	2	1	2.00	4	3	1.33
Phase III-3: Sum	205	123	1.67	81	61	1.33	286	184	1.55
Phase III: Sum	590	384	1.54	200	154	1.30	790	538	1.47
Total: Sum	739	470	1.57	255	185	1.38	994	655	1.52

Tab. 8-12: Overview of seals and other marine mammal specimens counted during vessel-based transect surveys in subareas 'Vessel West' (VW) and 'Vessel East' (VE) (dol = dolphin sighting).

Date	Harbour seal			Grey seal			Seal indet.			Cetacean indet.			Total
	VW	VE	Sum	VW	VE	Sum	VW	VE	Sum	VW	VE	Sum	
11.02.2008	11	1	12										12
23.07.2008		1	1										1
Phase I: Sum	11	2	13	0	0	0	0	0	0	0	0	0	13

Date	Harbour seal			Grey seal			Seal indet.			Cetacean indet.			Total
	VW	VE	Sum	VW	VE	Sum	VW	VE	Sum	VW	VE	Sum	
01.04.2009	4	2	6										6
12.04.2009	1		1								1 dol	1	2
03.08.2009	1		1										1
11.10.2009							1		1				1
18.10.2009				1	2	3	1		1				4
10./11.11.2009		5	5										5
10./11.12.2009		1	1										1
Phase II: Sum	6	8	14	1	2	3	2	0	2	0	1	1	20
07.04.2010		1	1										1
04.07.2010	1	2	3										3
01.08.2010	7	1	8				6		6				14
17.08.2010	7	2	9					1	1				10
13.09.2010		1	1										1
21.09.2010	5	2	7	1		1							8
31.10./01.11.2010							1		1				1
19./20.11.2010	1		1										1
27./28.11.2010		1	1	1		1							2
20./21.12.2010	1	1	2	1		1	2		2				5
Phase III-1: Sum	22	11	33	3	0	3	9	1	10	0	0	0	46
20./21.01.2011	1		1				1		1				2
28./29.01.2011	4		4				1	1	2				6
13./15.02.2011	3		3				2		2				5
02.03.2011							1		1				1
13.03.2011	4	2	6										6
27./28.03.2011	2		2	2		2	1		1				5
05./10.04.2011					1	1							1
17./18.04.2011		3	3					1	1				4
07.05.2011	1	3	4										4
21.05.2011	3	2	5							1	1		6
09.06.2011		1	1										1
22.08.2011	5		5				1	1	2				7
16.09.2011	4		4				1		1				5
25.09.2011	2	1	3					1	1				4
01.10.2011	12	4	16										16
16.10.2011		2	2										2
28.10.2011		1	1										1
19.-21.11.2011	1		1							1		1	2
22./23.12.2011	7		7										7
Phase III-2: Sum	49	19	68	2	1	3	8	4	12	1	1	2	85
28./29.01.2012	1	2	3										3
03./04.02.2012		1	1										1
27.02.2012		2	2							1	1		3
06.03.2012		1	1										1
18.03.2012		1	1				1		1				2
14.04.2012	1		1				1		1				2
07.05.2012	1		1					1	1				2
23.05.2012		1	1										1
30.05.2012		5	5										5
05.08.2012	2	1	3	1		1							4
03.09.2012							2		2				2
11.10.2012	1		1				3		3				4
18.10.2012				2		2							2
24.10.2012		1	1										1
14./15.11.2012	3	1	4	2	1	3							7
24.11.2012	1		1										1
16./17.12.2012		1	1										1
05./06.01.2013	1		1	1		1							2
09./10.02.2013	1		1				1		1				2
05.03.2013					1	1							1
29.03.2013		1	1										1
Phase III-3: Sum	12	18	30	6	2	8	8	1	9	0	1	1	48
Phase III: Sum	83	48	131	11	3	14	25	6	31	1	2	3	179
Total: Sum	100	58	158	12	5	17	27	6	33	1	3	4	212

8.3.3 Passive acoustic monitoring

Phenology

Phenologies were interpreted as follows on the base of raw data and moving-average trend lines for 30, 90, 183, and 365 days (Fig. 8-7, Fig. 8-8, Fig. 8-9, Fig. 8-10).

On a temporal scale of 30 days (one month) very low detections rates were registered for the 'Impact Area' from May to July 2009, spanning much of the Construction phase of alpha ventus (Fig. 8-7). To a lesser amount this pattern was also found in 2010 and 2011, but not in 2012. Thus, the 2009 pattern was probably caused by a mixture of construction, seasonal, and unknown effects. Apparently, the Repower pile-drivings in August 2009 did not adversely affect porpoise detection rates in the 'Impact Area'. A very similar pattern was found for the area 'Reference close'. At 'Reference distant' the detection rates were phenologically similar, but higher than those of the former two station clusters. An effect of pile-drivings became less clear than for the 'Impact Area' and 'Reference close'. Highest *PP10M/day* values were registered at 'Borkum Reef Ground', where also the seasonal pattern differed much from that of the other three clusters (see Fig. 3-19).

The seasonal pattern emerged more clearly on the temporal scale of 90 days (three months). At 'Borkum Reef Ground' the phenologies peaked in June and July, as well as in early winter and early spring (Fig. 8-8). Low rates were found in autumn. The other three station clusters were characterised by peaks in early spring and autumn.

On a half-year scale (183 days) direct effects of pile-drivings were not assessable anymore by the moving-average curves (Fig. 8-9), and on a long-term temporal scale (365 days) all seasonal effects were smoothed by averaging the detection rates of 365 days (Fig. 8-10). The long-term trend described above became clearer here. Both for the 'Impact Area' and 'Reference close' the rates started to increase permanently from 2010 onwards until the end of the smoothing line (autumn 2012), when the level of 2008 was reached again. Such a long-term increase of *PP10M/day* values was not found at 'Borkum Reef Ground', and only to a minor extent at 'Reference distant', anticipating the results of the subsequent time-series analyses (p. 63).

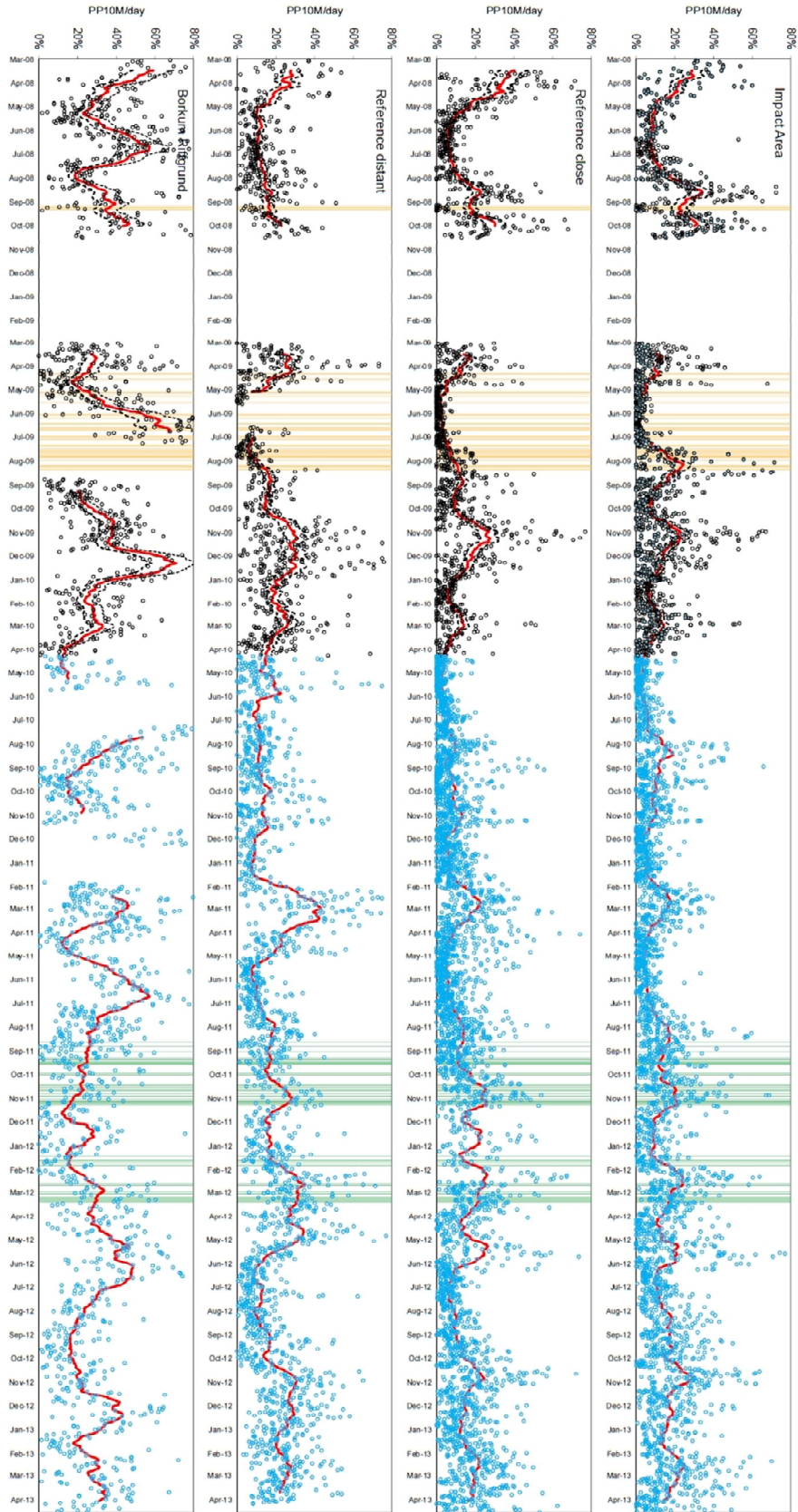

Fig. 8-7: Phenologies with 30-days moving average (red line) from 2008 to 2013 at the investigated station clusters (Impact Area, Reference Close, Reference Distant, Borkum Reef Ground; not shown: Reference Southwest and Reference East); black dotted lines: 95%-confidence intervals for T-POD based moving average values; orange lines: alpha ventus pile-drivings; green lines: Trianel Windpark Borkum, Phase I pile-drivings.

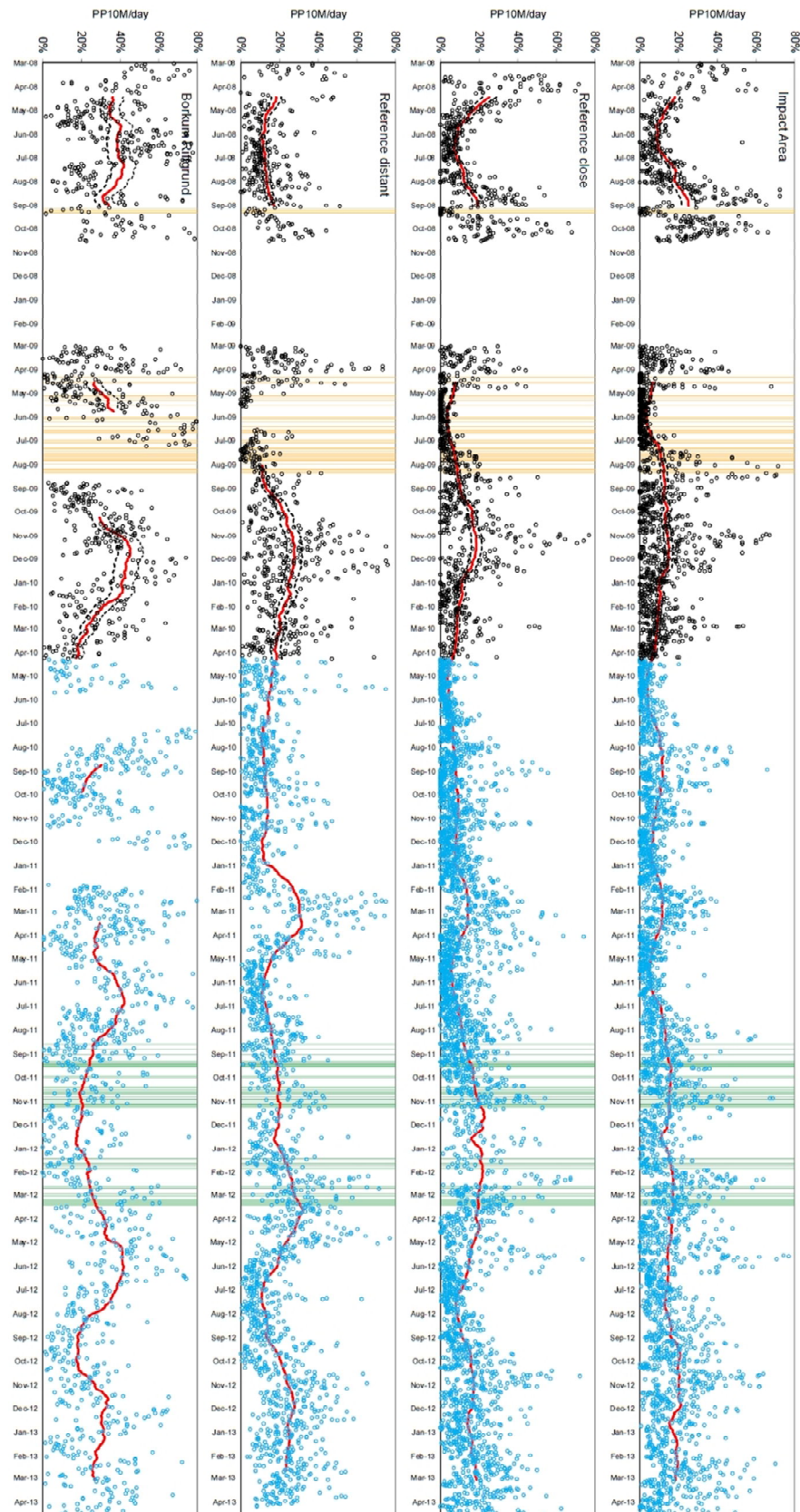

Fig. 8-8: Phenologies with 90-days moving average (red line) from 2008 to 2013 at the investigated station clusters (Impact Area, Reference Close, Reference Distant, Borkum Reef Ground; not shown: Reference Southwest and Reference East); black dotted lines: 95%-confidence intervals for T-POD based moving average values; orange lines: alpha ventus pile-drivings; green lines: Trianel Windpark Borkum, Phase I pile-drivings.

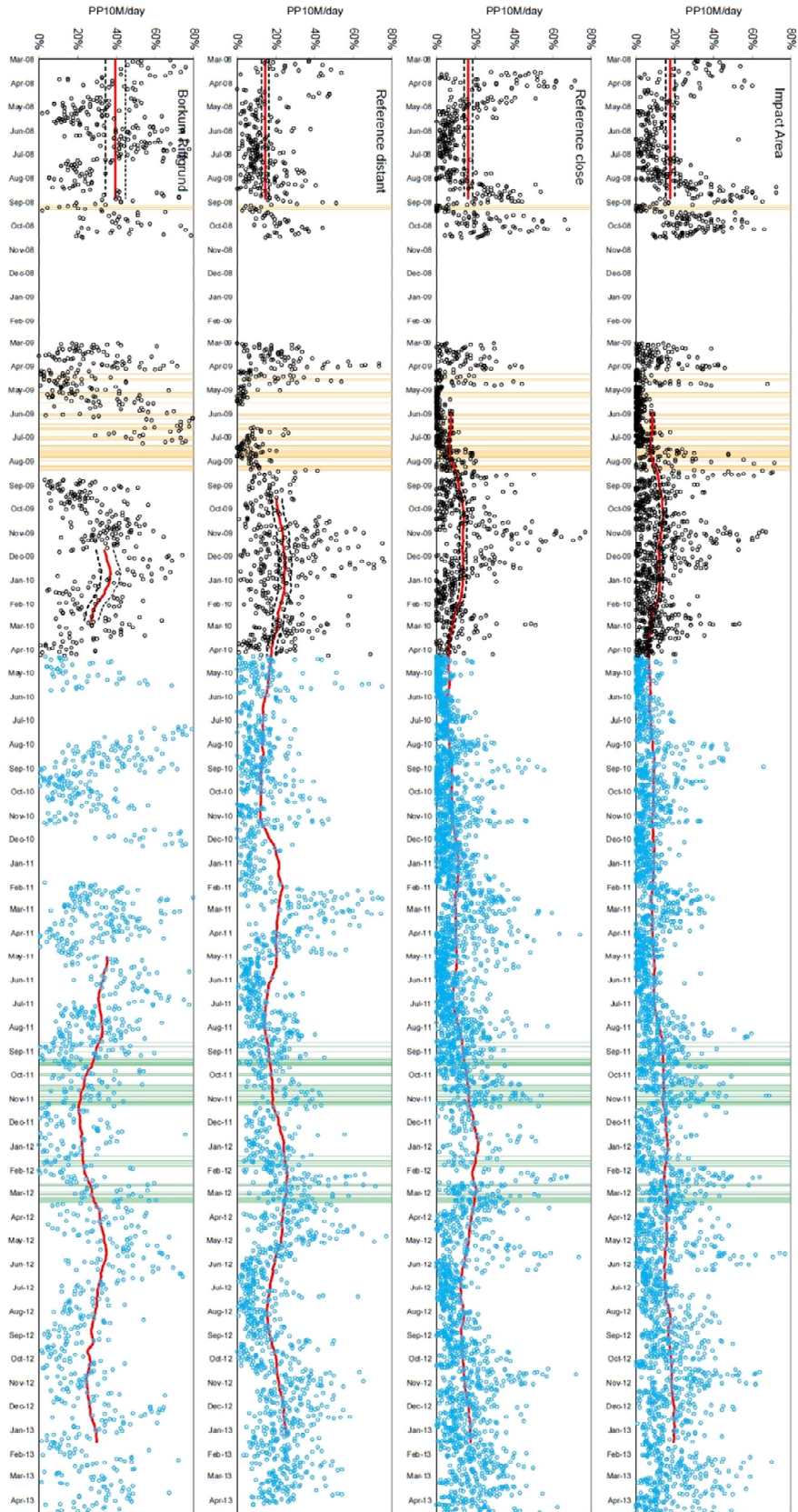

Fig. 8-9: Phenologies with 183-days moving average (red line) from 2008 to 2013 at the investigated station clusters (Impact Area, Reference Close, Reference Distant, Borkum Reef Ground; not shown: Reference Southwest and Reference East); black dotted lines: 95%-confidence intervals for T-POD based moving average values; orange lines: alpha ventus pile-drivings; green lines: Trianel Windpark Borkum, Phase I pile-drivings.

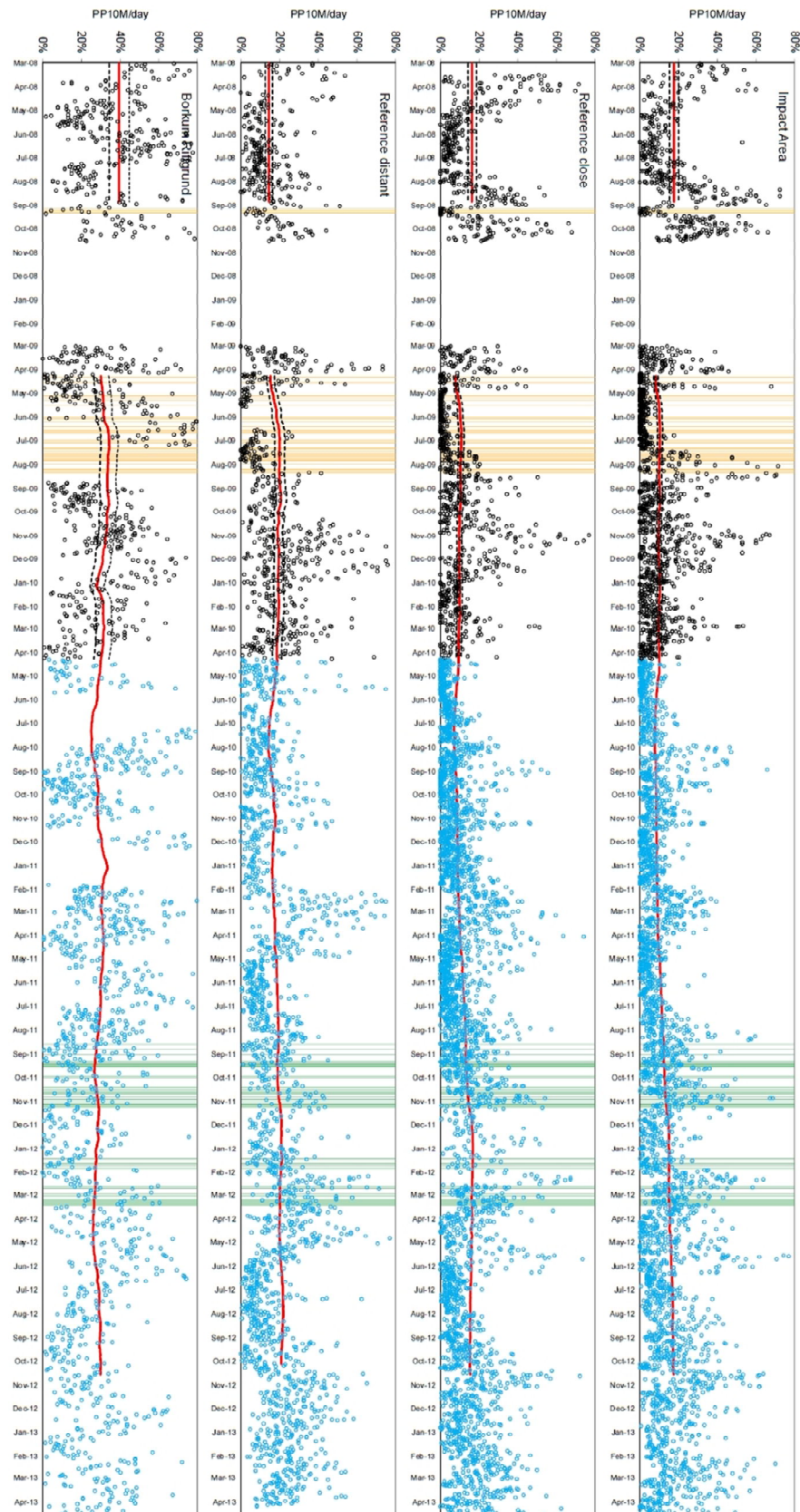

Fig. 8-10: Phenologies with 365-days moving average (red line) from 2008 to 2013 at the investigated station clusters (Impact Area, Reference Close, Reference Distant, Borkum Reef Ground; not shown: Reference Southwest and Reference East); black dotted lines: 95%-confidence intervals for T-POD based moving average values; orange lines: alpha ventus pile-drivings; green lines: Trianel Windpark Borkum, Phase I pile-drivings.

Pile-driving effects: Daily resolution

Control models

GAM control models were computed with data from 2008 (Tab. 8-13), including hypothetical pile-drivings at the same calendary dates as in 2009. The seasonal effect computed by GAMs was slightly different between 2008 and 2009. Within distance classes 1 and 2, daily detection rate (*PP10M/day*) estimates were higher than the overall mean in April 2008, afterwards declining until June with a subsequent increase until September (Fig. 8-11 and Fig. 8-12, right panels). By contrast, in April 2009 the detection rate estimates were already lower than the overall mean, namely in distance classes 1 and 3 (Fig. 3-23 and Fig. 3-25, right panels). Within distance class 3 no consistent seasonal pattern was found by GAM analysis (Fig. 8-13, right panels).

Tab. 8-13: GAM results (2008 data with hypothetical pile-drivings) regarding distance-dependent effects of the explanatory variables *Pile-driving* (day in relation to hypothetical pile-drivings after control model 1 and 2: see Section 2.4.7, p. 36), *Month*, *Position*, and *Year* on *PP10M/day*; for the factors *Year* and *Position* degrees of freedom (*df*), for the smoothing factors *Pile-driving* and *Month* error degrees of freedom (*edf*) are given.

Response variable: <i>PP10M/day</i>						
Distance class	Control model	Variable	df/edf	F	p value	% explained
1 (< 4 km)	1	<i>Pile-driving</i>	6.3	8.9	<0.001	42.0 %
		<i>Month</i>	3.7	61.3	<0.001	
		<i>Position</i>	9	4.9	<0.001	
	2	<i>Pile-driving</i>	1.0	4.8	<0.05	23.5 %
		<i>Month</i>	2.7	30.2	<0.001	
		<i>Position</i>	9	3.4	<0.001	
2 (4-10.2 km)	1	<i>Pile-driving</i>	2.0	1.8	0.16	35.8 %
		<i>Month</i>	17.0	17.0	<0.001	
		<i>Position</i>	1	2.1	0.15	
	2	<i>Pile-driving</i>	1.0	0.7	0.42	20.2 %
		<i>Month</i>	2.7	12.6	<0.001	
		<i>Position</i>	1	1.8	0.18	
3 (> 10.2 km)	1	<i>Pile-driving</i>	2.8	0.9	0.41	46.3 %
		<i>Month</i>	3.6	8.0	<0.001	
		<i>Position</i>	2	116.5	<0.001	
	2	<i>Pile-driving</i>	1.0	0.7	0.42	47.2 %
		<i>Month</i>	2.7	13.5	<0.001	
		<i>Position</i>	1	1.8	0.18	

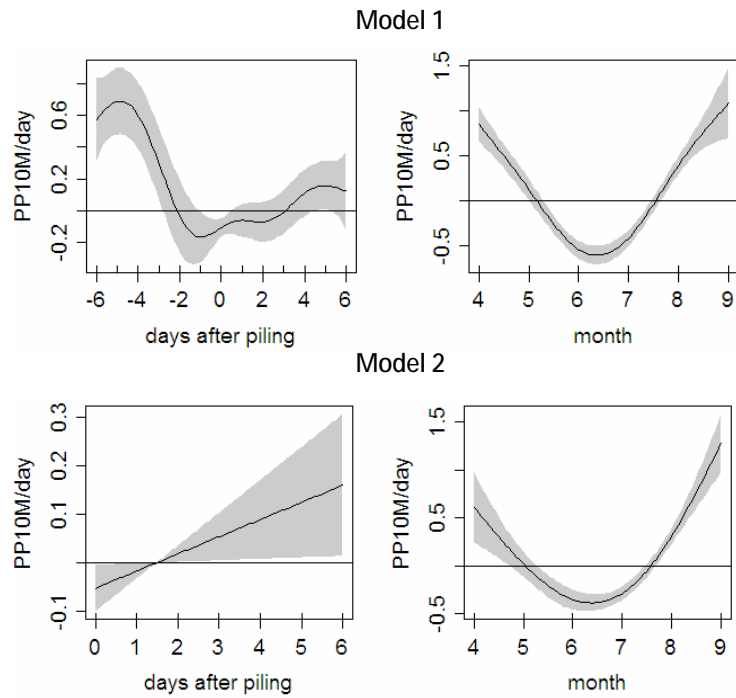

Fig. 8-11: GAM plots (2008 data with hypothetical pile-drivings) according to control model 1 and 2 (see Section 2.4.7, p. 36) for distance class 1 (stations T1-T7), visualising the control model outcome with hypothetical pile-drivings ('days after piling') and the effect of Month on daily harbour porpoise detection rates PP10M/day (see Fig. 3-23 for further information).

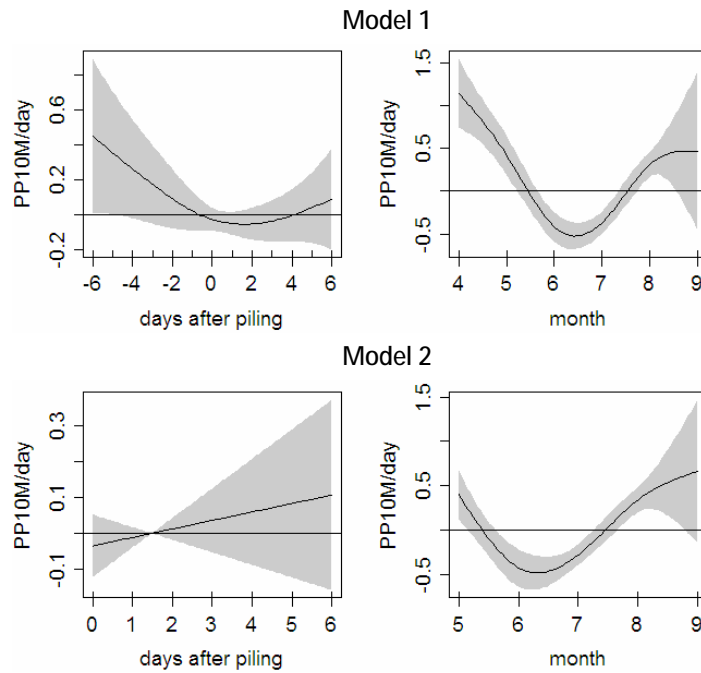

Fig. 8-12: GAM plots (2008 data with hypothetical pile-drivings) according to control model 1 and 2 (see Section 2.4.7, p. 36) for distance class 2 (stations T8 and T13), visualising the control model outcome with hypothetical pile-drivings ('days after piling') and the effect of Month on daily harbour porpoise detection rates PP10M/day (see Fig. 3-23 for further information).

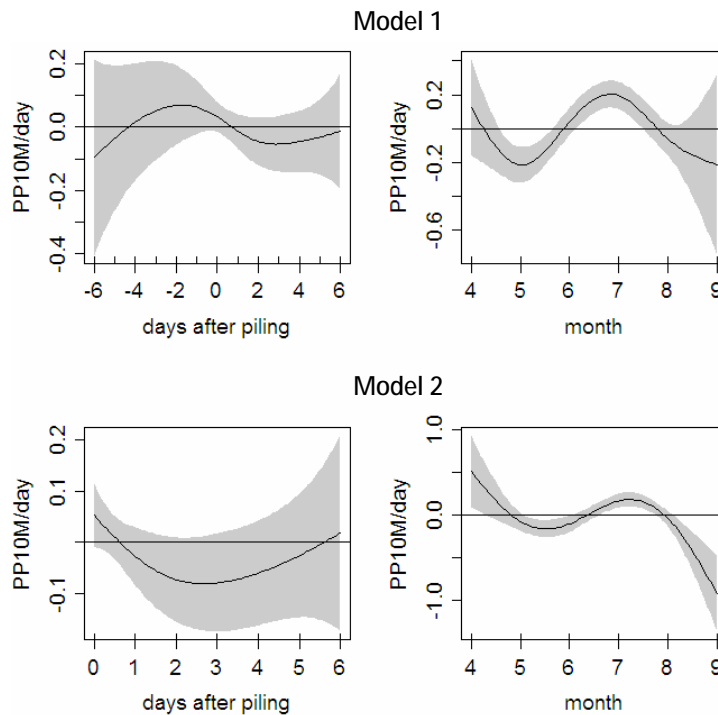

Fig. 8-13: GAM plots (2008 data with hypothetical pile-drivings) according to control model 1 and 2 (see Section 2.4.7, p. 36) for distance class 3 (stations T9-T11), visualising the control model outcome with hypothetical pile-drivings ('days after piling') and the effect of Month on daily harbour porpoise detection rates PP10M/day (see Fig. 3-23 for further information).