



THE UNIVERSITY *of* EDINBURGH

Edinburgh Research Explorer

Protocols for the Equitable Assessment of Marine Energy Converters

Citation for published version:

Ingram, D, Smith, G, Bittencourt Ferreira, C & Smith, H 2011, *Protocols for the Equitable Assessment of Marine Energy Converters*. University of Edinburgh. <<http://www.lulu.com/product/paperback/protocols-for-the-equitable-assessment-of-marine-energy-converters/15675151>>

Link:

[Link to publication record in Edinburgh Research Explorer](#)

Document Version:

Publisher's PDF, also known as Version of record

Publisher Rights Statement:

(c)2011 All Rights Reserved

No part of this publication may be reproduced, stored in a retrieval system, or transmitted in any form – electronic, mechanical, photocopy or otherwise without the express permission of the copyright holders.

This book is sold subject to the condition that it shall not, by way of trade or otherwise, be lent, re-sold, hired-out or otherwise circulated without the publishers prior consent in any form of binding or cover other than that in which it is published and without a similar condition including this condition being imposed on the subsequent purchaser.

General rights

Copyright for the publications made accessible via the Edinburgh Research Explorer is retained by the author(s) and / or other copyright owners and it is a condition of accessing these publications that users recognise and abide by the legal requirements associated with these rights.

Take down policy

The University of Edinburgh has made every reasonable effort to ensure that Edinburgh Research Explorer content complies with UK legislation. If you believe that the public display of this file breaches copyright please contact openaccess@ed.ac.uk providing details, and we will remove access to the work immediately and investigate your claim.



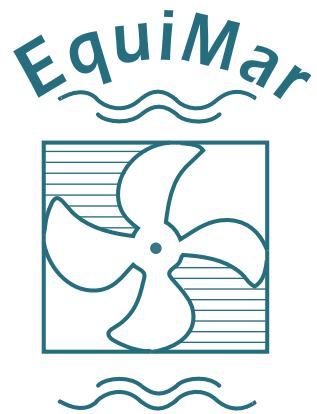

Protocols for the Equitable Assessment of Marine Energy Converters

Editors:

David Ingram

George Smith

Claudio Bittencourt-Ferreira

Helen Smith

Equitable Testing & Evaluation Of Marine Energy Extraction Devices in Terms of Performance, Cost and Environmental Impact, European Commission 7th framework programme grant agreement number 213380.

Published by The Institute for Energy Systems, School of Engineering, The University of Edinburgh, Mayfield Road, Edinburgh EH9 3JL, United Kingdom on behalf of the EquiMar project consortium.

First edition, 2011

©2011 All rights reserved.

No part of this publication may be reproduced, stored in a retrieval system, or transmitted in any form – electronic, mechanical, photocopy or otherwise without the express permission of the copyright holders.

This book is sold subject to the condition that it shall not, by way of trade or otherwise, be lent, re-sold, hired-out or otherwise circulated without the publishers prior consent in any form of binding or cover other than that in which it is published and without a similar condition including this condition being imposed on the subsequent purchaser.

ISBN 978-0-9508920-1-6 (hardback)
978-0-9508920-2-3 (paperback)
978-0-9508920-3-0 (electronic)

Set in Helvetica and Times using the \LaTeX type setting system.
Printed by LULU (www.lulu.com)

Acknowledgements

Funding from the EU Commission for the EquiMar project (Grant Agreement No. 213380) is acknowledged as is the help, in preparing the proposal and executing the project, of the partner institutions The University of Edinburgh, Fundación Robotiker, University of Strathclyde, Electricité de France SA, European Ocean Energy Association, University of Exeter, University College Cork, Wave Energy Centre, The University of Manchester, Southampton University, Institut Français de recherche pour l'exploitation de la mer, Consiglio nazionale delle ricerche: Istituto di Scienze Marine, Det Norske Veritas, Teamwork Technology, Pelamis Wave Power Ltd, European Marine Energy Centre, Wave Dragon, Uppsala University, Sea Mammal Research Unit, Scottish Association of Marine Sciences, Feisty Productions Ltd, Aalborg University, and Actimar.

David Ingram wishes to acknowledge support for his Chair from the Scottish Funding Council and for their support of the Joint Research Institute in Energy with the Heriot-Watt University as a component part of the Edinburgh Research Partnership.

This project would not have been successful without the valuable guidance of the external members of our project steering committee; Christina Huertas-Olivares (Abengoa), Anne-Claude Vaudin (IUCN), Melanie Nadeau (IEC TC114), John Huckerby and Jochen Bard (IEA-OES).

Finally we would like to thank Janet Taylor for her hard work throughout the project and for keeping us all in order, and Alan Anderson for re-formatting all the protocol documents into \LaTeX .

Contents

I	Introduction	1
1	The EquiMar project	3
1.1	Introduction	3
1.1.1	The EquiMar work packages	3
1.1.2	Background	7
1.1.3	Deliverables	8
1.1.4	The Need	8
1.2	High level protocol descriptions	10
1.3	Review of Methodology and Process	12
1.3.1	Engagement and External Review	13
2	The Management of Risk	15
3	High Level Protocols	17
3.1	Resource Assessment	17
3.2	Environmental Assessment	20
3.3	Tank Testing	25
3.4	Sea Trials	29
3.5	Performance Assessment of Multi-Megawatt Device Arrays	33
3.6	Economic Assessment of a Marine Energy Project	37
II	Detailed Protocols	41
I.A	Resource Assessment	43
I.A.1	Introduction	43
I.A.1.1	Need for resource assessment	43
I.A.1.2	Scope	44
I.A.2	Wave Resource Characterisation and Site Assessment	45
I.A.2.1	Overview	45
I.A.2.2	Key Wave Parameters	47
I.A.3	Wave Measurement	52
I.A.3.1	Measurement process	52
I.A.3.2	Methods of analysis	54
I.A.4	Wave Modelling	56
I.A.4.1	Rationale	56
I.A.4.2	Offshore boundary conditions	57
I.A.4.3	Bathymetry	58
I.A.4.4	Metocean conditions	58
I.A.4.5	Calibration and validation	59
I.A.5	Interpretation and application of data to wave energy developments	59
I.A.5.1	Presentation of data	59
I.A.5.2	Spatial variation	60

I.A.5.3	Extreme Value Analysis Requirements	61
I.A.6	Tidal Resource Characterisation and Site Assessment	61
I.A.6.1	Overview	61
I.A.6.2	Key tidal parameters	63
I.A.7	Tidal Measurement	64
I.A.7.1	Measurement process	64
I.A.7.2	Data types	65
I.A.7.3	Methods of measurement	65
I.A.7.4	Methods of analysis	66
I.A.7.5	3.3.3 Quantification of uncertainty	66
I.A.8	Tidal Modelling	67
I.A.8.1	Rationale	67
I.A.8.2	Offshore Boundary Conditions	67
I.A.8.3	Bathymetry	68
I.A.8.4	Metocean conditions	68
I.A.8.5	Calibration and validation	68
I.A.9	Interpretation and application of data to tidal energy developments	69
I.A.9.1	Presentation of data	69
I.A.9.2	Spatial variation	69
I.A.9.3	Extremes	70
I.A.10	Site Considerations	71
I.A.10.1	Constraints on Exploitation	71
I.A.10.2	Device Survivability and Assessment of Extremes	71
I.A.10.3	Sample Size	72
I.A.10.4	n-year individual wave height	72
I.A.11	Reporting	73
I.B	Environmental Assessment	79
I.B.1	Environmental assessment approaches	79
I.B.1.1	Strategic Environmental Assessment	79
I.B.1.2	Environmental Risk Assessment	80
I.B.1.3	Life Cycle Assessment	81
I.B.2	Adaptive management	83
I.B.3	Site selection and conceptual design: environmental concerns	83
I.B.4	Environmental Impact Assessment guidelines	84
I.B.4.1	Screening	84
I.B.4.2	Scoping	85
I.B.4.3	Baseline studies	86
I.B.4.4	Impact analysis	89
I.B.4.5	Consultation	91
I.B.4.6	Mitigation and impact management	94
I.B.4.7	Monitoring	94
I.B.5	Impact analysis tools	96
I.B.5.1	Checklists	96
I.B.5.2	Matrices	98
I.B.5.3	Geographic Information Systems	101
I.B.5.4	Mathematical modelling	103
I.B.6	Environmental key issues	104
II.A	Tank Testing	115
II.A.1	Introduction - Experimental Good Practice	115

II.A.1.1	Purpose of the Test	117
II.A.1.2	Outline Test Procedure	118
II.A.2	Quality and Accuracy of Results	120
II.A.2.1	Statistical Definitions	121
II.A.2.2	Frequency Domain Analysis	122
II.A.3	Design of Experiment	127
II.A.3.1	Choice of an Experimental Design	127
II.A.3.2	Description of Experimental Designs	128
II.A.3.3	Replication and Choice of Factor Values	131
II.A.4	Uncertainty Analysis (UA) and Data Quality Assurance Procedures	132
II.A.4.1	Methodology	133
II.A.4.2	Propagation of Uncertainty	134
II.A.4.3	Standard Uncertainty - Type A UA	135
II.A.4.4	Standard Uncertainty - Type B UA	135
II.A.4.5	Sensitivity Analysis and Estimation of Bias Limits	135
II.A.4.6	Estimating Precision Limits	138
II.A.4.7	Data Quality Assurance Procedures	139
II.A.4.8	Correlation	141
II.A.4.9	Outliers	142
II.A.5	Calibration [Of Sensors]	144
II.A.5.1	Force	144
II.A.5.2	Air Temperature, Density, Pressure and Viscosity	144
II.A.5.3	Speed and Velocimetry	144
II.A.6	Experiments on Extreme or Rarely Occurring Events	145
II.A.6.1	Rarely Occurring Wave Conditions	146
II.A.6.2	Rarely Occurring Tidal Conditions	146
II.A.6.3	Scale Recommendation	146
II.A.6.4	Reporting	146
II.A.6.5	Required Measurements	146
II.A.7	Qualities of Prototype Models	148
II.A.7.1	Power Take Off	148
II.A.8	Archival and Storage of Data	149
II.A.9	Documentation	151
II.B	Field Trials	157
II.B.1	Introduction	157
II.B.1.1	A Five Stage Device Development Programme	157
II.C	Multi-Megawatt Arrays	159
II.C.1	The need for guidance	159
II.C.2	Pre-deployment	159
II.C.3	Device classification	160
II.C.3.1	Guidance for assessment of the marine energy supply chain	161
II.C.3.2	Guidance on determining appropriate electrical connections	163
II.C.3.3	Guidance on shared sub-systems and array operations	169
II.C.3.4	Matching devices to the marine environment	170
II.C.3.5	Guidance for Interaction effects between devices in an array	171
II.C.3.6	Guidance on impacts to marine energy stakeholders	175
II.C.4	Performance Assessment	175
II.C.4.1	Quantification of performance parameter for arrays and individual devices	175
II.C.4.2	Quantifying the inflow to an array	176

II.C.5	Modular installation of arrays	177
II.C.6	Recording and reporting of temporal information	179
III.A	Project Assessment	181
III.A.1	The Need for Economic Assessment of A Marine Energy Project	181
III.A.1.1	Reporting from Economic Assessment of a Project	181
III.A.1.2	Assessment Method	182
III.A.2	Capital Cost - Methodology	184
III.A.2.1	Preliminary Works	184
III.A.2.2	Marine Energy Devices	185
III.A.2.3	Civil Engineering Infrastructure	185
III.A.2.4	Electrical Infrastructure	187
III.A.2.5	Site to grid transmission	187
III.A.2.6	Deployment - Offshore Vessels	188
III.A.2.7	Other capital expenditures	190
III.A.2.8	Decommissioning	190
III.A.3	Operating Cost - Methodology	190
III.A.3.1	Ongoing costs (Periodic Expenditures)	191
III.A.3.2	Maintenance	191
III.A.4	Revenue - Methodology	193
III.A.4.1	Energy production	193
III.A.4.2	Unit value of electricity	194
III.A.4.3	Revenue Calculation	194
III.A.5	Risk Assessment	195
III.A.5.1	Risk Associated with the Assessment Process	195
III.A.5.2	Risk Associated with an Investment	196
III.A.5.3	Project Specific Risk	196
III.A.6	Economic Assessment	197
III.A.6.1	Quantitative parameters	198
III.A.6.2	Investment Criteria	201

List of Figures

1.1	EquiMar work package structure	4
1.2	Interaction of protocol areas during the development of a project from initial device concept through to large scale deployment	4
1.3	Breakdown of the 115 stakeholders invited to complete the questionnaire on the High Level Protocols	14
3.1	Scope of the environmental assessment: wave and tidal project phase sequence and environmental concerns during the process.	23
I.A.1	The stages of a marine energy project, and how resource assessment will be utilised during each stage.	44
I.A.2	Resource assessment for the <i>early stage</i> aspect of a wave energy development.	45
I.A.3	Resource assessment for the <i>project development</i> stage of a wave energy development.	46
I.A.4	Resource assessment for the <i>operational</i> stage of a wave energy development.	47
I.A.5	Summary of methods used and data required for resource assessment at each stage of a wave energy development.	48
I.A.6	Methods for obtaining key parameters from resource assessment	48
I.A.7	Calculation of the directional spectrum from raw time series data.	55
I.A.8	Summary of the required inputs and expected outputs for numerical modelling for wave energy resource assessment.	57
I.A.9	Resource assessment for the <i>early stage</i> aspect of a tidal energy development. TODO find appropriate pdf to include	61
I.A.10	Resource assessment for the <i>project feasibility</i> stage of a tidal energy development. TODO find appropriate pdf to include	62
I.A.11	Resource assessment for the <i>project development</i> stage of a tidal energy development. TODO find appropriate pdf to include	62
I.A.12	Resource assessment for the <i>operational assessment</i> stage of a tidal energy development. TODO find appropriate pdf to include	63
I.A.13	Methods for obtaining key parameters from resource assessment.	63
I.A.14	Typical representation of return values.	73
I.B.1	A framework for environmental risk assessment; QRA: Quantitative Risk Assessment (adapted from [5]).	80
I.B.2	A framework for integrated risk analysis of renewable energy deployments (from [6]). TODO find appropriate pdf to include	81
I.B.3	Phases of a LCA (adapted from [7]).	82

I.B.4	Esquemathic representation of the Environmental Impact Assessment methodology (adapted from [19]).	85
I.B.5	Conceptual framework for baseline description and guidance/recommendation regarding wave and tidal energy projects.	88
I.B.6	Leopold matrix instructions (based on [45]).	100
I.B.7	Simple matrix (based on Leopold matrix) for impacts identification of a wave energy converter [46].	100
I.B.8	Central questions answered by a GIS during an Environmental Impact Assessment process (adapted from [50])	101
I.B.9	Criteria and instructions for RIAM (Rapid Impact Assessment Matrix) application in EIA ([48] and [49]).	103
II.A.1	Flow chart of experimental process, indicating decision points and information sources. Adapted from ITTC Procedure 7.5-02-01-02 [10].	119
II.A.2	Illustration of Precision and Accuracy components of experimental uncertainty, and also the notion of a probability density function.	120
II.A.3	Illustration of qualitative Precision and Accuracy components of experimental uncertainty, and also the effects on a probability density function.	120
II.A.4	Illustration of a noisy time series of data, and the associated histogram of values.	121
II.A.5	Illustration of windowing, tapering and overlapping.	124
II.A.6	Velocity measurement in a towing tank facility	126
II.A.7	The 4-Plot for a data series.	142
II.A.8	Linear Correlation Example. Taken from Wikimedia.	143
II.A.9	Example metadata from a LabVIEW file.	150
II.B.1	The five stage development programme for marine energy converters	158
II.C.1	Schematic subsystem diagram of tidal (left) and wave (right) energy devices	160
II.C.2	Evolution of the marine energy supply chain	162
II.C.3	Scheme of the elements of a marine energy farm connection interface. TODO - figures not very legible	166
II.C.4	Main types of clustering for marine energy farms.	167
II.C.5	Electrical integration configurations	168
II.C.6	2-Row wave energy array (left) and 3-row tidal array (right) TODO - missing figures	170
II.C.7	Increase in spatial extent of downstream wake (dashed lines) for increasing directional inflow	172
II.C.8	Single row 1 st -generation arrays (line absorber (left), point absorbers (centre) and tidal turbines (right) TODO missing figure	173
II.C.9	Dual row 1 st -generation arrays (tidal (left), wave (right) TODO missing figure	173
II.C.10	2 nd -generation arrays (tidal (left), point-absorber wave (right) TODO missing figure	174
II.C.11	Array resource measurements might require increased spatial coverage.	176
II.C.12	Tidal Array installation over varying depth will require increased measurement to accurately define inflow conditions.	177

II.C.13	informing array design through additional resource measurements. TODO missing figure	178
III.A.1	CAPEX Calculation Flowchart (Fig 1, EQUIMAR D7.2.1) TODO - figure missing	184
III.A.2	OPEX calculation flowchart (Fig 2, EQUIMAR D7.2.1) TODO - figure missing	191
III.A.3	Revenue calculation flowchart (Fig 3, EQUIMAR D7.2.1) TODO - figure missing	193
III.A.4	Schematic indicating the change of emphasis of an economic assessment of a marine energy project with increasing technology development. Values are indicative only. TODO - figure missing	202

List of Tables

1.1	Partners organisations comprising the EquiMar consortium	5
1.2	EquiMar protocol numbering system	6
1.3	List of publicly available project deliverable reports	9
I.A.1	Key wave parameters obtained through resource assessment	50
I.A.2	Definition of key parameters in terms of spectral moments.	55
I.A.3	Key tidal parameters	63
I.A.4	Common tidal constituents, in usual order of importance.	64
I.B.1	Examples of criteria that should be considered when selecting a potential development site for a given development design (adapted from [18]).	84
I.B.2	Example list (non-exhaustive) of key information to be submitted in a formal scoping report (adapted from [20] and [18]).	87
I.B.3	Type of issues that might be considered under the baseline line survey (adapted from [18]).	89
I.B.4	Example of a set of marine valuation criteria and their definitions [27]. These criteria were selected from three different sources of literature: articles on peer-review articles, reports on selection criteria for Marine Protected Areas (MPAs) and international legislative documents that include selection criteria (e.g. EC Birds and Habitats Directives, RAMSAR convention, OSPAR guidelines, UNEP Convention on Biological Conservation).	90
I.B.5	Commonly used methods for impact identification and prediction (adapted from [20] and [21]).	92
I.B.6	Example of classification criteria used in impact valuation.	93
I.B.7	Environmental interactions / potential impacts of wave and tidal energy developments and its relative prioritization. The priority column represents the relative prioritisation for the development of new monitoring methods where there are no well established best practices. This does mean that an issue which is considered important for the industry, but for which there are well established monitoring methods available, the priority ranking will be low since no new methods need to be developed [29].	95
I.B.8	Examples of environmental monitoring methodologies regarding wave and tidal energy project installation, operation and decommissioning.	97
I.B.9	Possible screening checklist for an ocean energy project.	99
I.B.10	GIS and Environmental Impact Assessment steps (adapted from [20]).	102
I.B.12	Examples of recent reports on reviews of environmental key issues of wave and tidal energy developments.	106
I.B.13	Key environmental issues to be considered in the environmental assessment. . .	107
II.A.1	Summary of example results	126
II.A.2	Appropriate Design of Experiments methods by purpose and number of factors.	128
II.A.3	Randomised Design of Experiment Test Matrix	129

II.A.4	Blocking Design of Experiment Test Matrix	130
II.A.5	Full Factorial Design of Experiment Test Matrix	130
II.A.6	Uncertainty Estimates from Assumed Distributions	136
II.A.7	Sensitivity Analysis for a Tidal Turbine	138
II.A.8	Combined Uncertainty for some Standard Forms of DRE	140
III.A.1	Summary of methods and data required for economic assessment for three different stages of development of an arbitrary marine energy conversion technology.	183
III.A.2	Methods for determining the duration of conditions suitable for offshore work.	190
III.A.3	Example list of other costs that may be incurred prior to commissioning.	190
III.A.4	Factors affecting estimate of Capital Cost, their impact and possible mitigation (EXAMPLE)	197
III.A.5	Factors affecting estimate of Operating Cost, their impact and possible mitigation (EXAMPLE)	198
III.A.6	Specific risks affecting estimate of Project Revenue with example of Impacts & Mitigation	199
III.A.7	Additional risks to be mitigated (EXAMPLE).	200

Part I

Introduction

Chapter 1

The EquiMar project

1.1 Introduction

The EquiMar project was funded by the European Commission under the 7th Framework Programme in response to the topic 2.6.3 of the ENERGY-2007-1-RTD call. The call was established to conduct pre-normative research aiming at harmonised testing methods and comparative assessment of ocean energy converters in terms of monitoring the performance, cost, and environmental impact. The expected outcome of this work was that the harmonised testing and assessment of ocean energy converters would facilitate the matching of different system designs to various marine environments, and accelerate their rate of deployment. The call fiche also noted that the commission expected small or medium sized enterprises (SMEs) to play a major role in the project.

In response to this call a consortium of 23 partners from 11 countries (Table 1.1) was brought together. The consortium reflected the fact that the equitable evaluation required a broad, multidisciplinary skill set. In addition if the protocols developed were to be accepted by the wider community then the consortium needed to engage with both the developers and end-users of this technology. In constructing the consortium for the project we sought to bring together leading European experts (from both academic groups and research organisations), developers of proven devices, test sites, certification agencies and end users of the technology. The core members of the consortium comprised academic groups, research laboratories and device developers and it was these members who have had the most direct input to the equitable evaluation protocols. However, since EquiMar aimed to produce a set of protocols for research funders, consenting authorities, investors and device owners the consortium also contained partners representing certifying authorities, industrial associations, end users and test sites. The need to include such diverse interests led to an unusually large consortium (Table 1.1).

1.1.1 The EquiMar work packages

The EquiMar project was split into ten work packages (Figure 1.1), six of which (WP2 to WP7) were directly concerned with the development of a draft protocol and the underpinning research necessary to deliver it. The draft protocols were passed through a consultation and synthesis process, under the control of a seventh work package (WP8) before being disseminated to the wider community (WP9). The protocols developed fell into four distinct groups, dealing with the Physical Environment, Engineering Assessment, Environmental Assessment and Economic Assessment. The remaining work packages (WP1 and WP9) are concerned with the background knowledge and project management and coordination activities.

An alternative way of thinking about the work packages is as a process, which follows the development stages of an energy extraction technology from initial concept through to large scale testing and evaluation (Figure 1.2). An important focus is to consider the effect of developing arrays

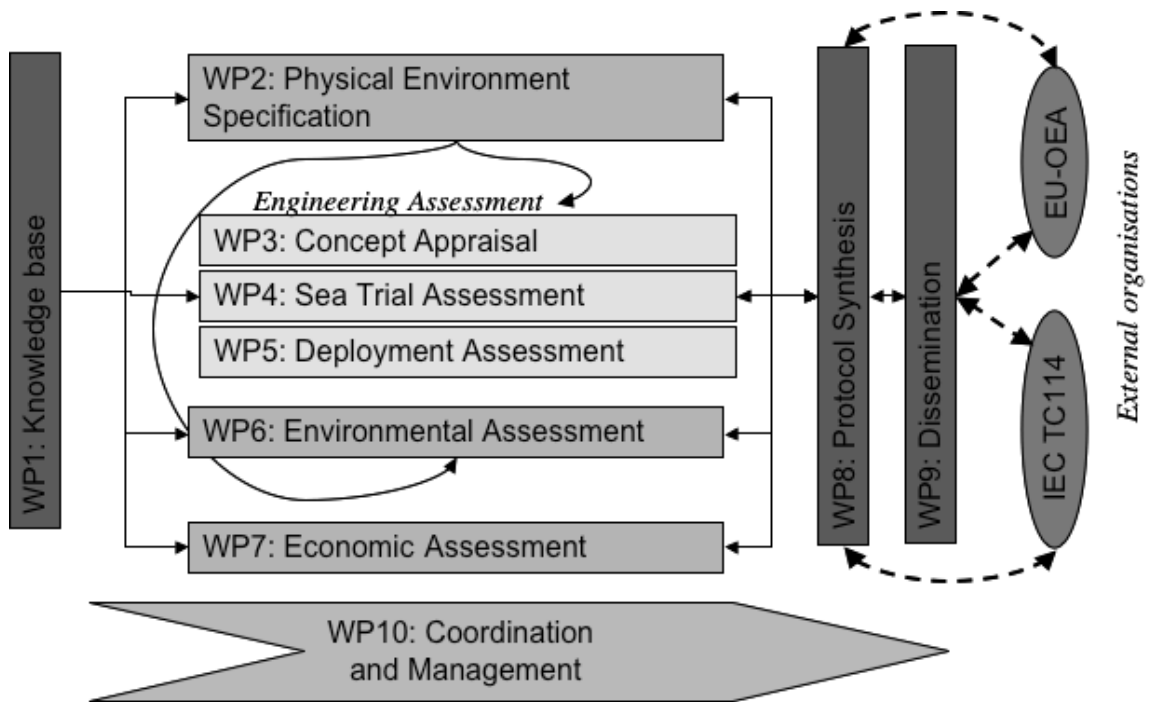

Figure 1.1: EquiMar work package structure

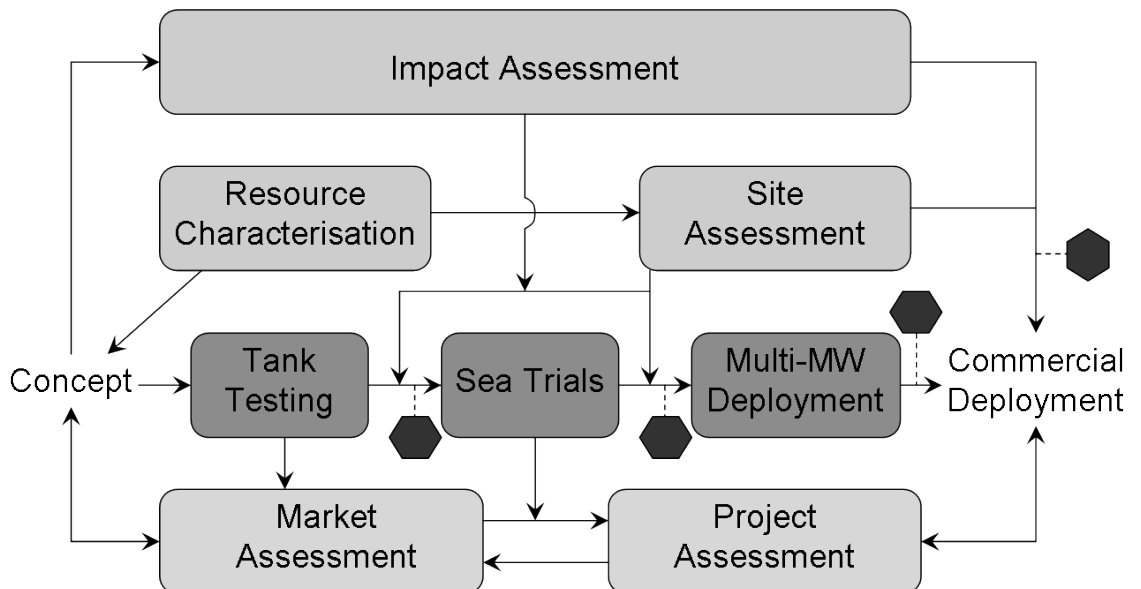

Figure 1.2: Interaction of protocol areas during the development of a project from initial device concept through to large scale deployment

Table 1.1: Partners organisations comprising the EquiMar consortium

Partner	Country
The University of Edinburgh	UK
Fundación Robotiker	ES
University of Strathclyde	UK
Electricité de France SA	FR
European Ocean Energy Association	BE
University of Exeter	UK
University College Cork	IE
Wave Energy Centre	PT
The University of Manchester	UK
Southampton University	UK
Institut Français de recherche pour l'exploitation de la mer	FR
Consiglio nazionale delle ricerche: Istituto di Scienze Marine	IT
Det Norske Veritas	NO
Teamwork Technology	NL
Pelamis Wave Power Ltd	UK
European Marine Energy Centre	UK
Wave Dragon	DK
Sea Mammal Research Unit	UK
Scottish Association of Marine Sciences	UK
Feisty Productions Ltd	UK
Aalborg University	DK
Actimar	FR

of devices, since physical constraints mean that it is unlikely that a single marine energy converter will have a rated capacity of much larger than 1MW. In following the decision process outlined in Figure 1.2 a technology developer is likely to start with an initial concept, based in part on an understanding of the available resource and the likely future market. This initial concept should then be tested at small scale in a controlled environment using both tank testing and computer simulations to understand the behaviour and limitations of the primary interface of the energy converter. Such small-scale tests allow mooring geometries, likely wake and radiated wave effects to be explored and detailed survival and operating envelope tests to be performed. All the successful wave and tidal energy concepts (to date) have taken this initial, cautious, approach, which takes advantage of the relatively low costs of learning lessons at small scale in the laboratory before moving up to larger laboratory scale. At the end of this stage a detailed analysis of the laboratory test results can be combined with information about the conditions at test locations to decide if sea-trials should be commissioned.

A programme of sea-trials represents the first occasion under which the device is subjected to an uncontrolled environment. Although best practice would be to deploy the device into the ocean at circa 1:4 scale, there are only three (out of the 16 current and proposed) European test sites (Nissum Bredding [DK], Galway Bay [IE] and EMEC [UK]) that operate at this scale. Sea trials allow the technology developer to learn how the device performs in the open ocean and critically to understand the processes, vessels and equipment needed for installation, operation, maintenance and recovery of the device for the first time. The cost of performing such trials is at least an order of magnitude more than that associated with even large-scale laboratory tests. The view taken by EquiMar was that such sea-trials extend to small, pre-commercial, array deployments (*cf.* the Pelamis deployment in Portugal) and may require several generations of full scale devices to be

deployed at several test locations before sufficient information is collected about the operability and reliability of a particular technology is available to allow for commercial deployment.

Site assessment is the key starting point for the commercial deployment of a multi-megawatt array. The selection of a site must be based not only on the available local resource but also on other marine spatial planning considerations, such as the location of shipping lanes, fishing grounds and underwater pipes and cables as well as on the strength of the local electricity grid. Following the selection of a site there will be a significant amount of work in obtaining the required consents and this should be the first time the devices are to be deployed outwith a recognised sea-trial area. After the selection and characterisation of the site the specific operating envelopes of the machines to be deployed will be designed and full-scale deployment can begin.

The go/no-go decision on a commercial deployment will be extremely complex and information about the installation, operating and removal costs of the technology will be critical. Improved technology pricing models drawing on the engineering information available from model, scale and prototype tests is critical to this stage as it allows legislators and possible investors to make informed decisions about revenue streams.

This procedural analysis allowed a system of protocols subdivided into three parts (Environment, Engineering and Economic), each of which contains a number of individual protocols, to be proposed. The EquiMar protocols are numbered as follows (Table 1.2):

Table 1.2: EquiMar protocol numbering system

I	Environmental	
I.A		Resource Assessment
I.B		Impact Assessment
II	Engineering	
II.A		Tank (controlled environment) Testing
II.B		Sea (uncontrolled environment) Trials
II.C		Large Scale (multi-MW) Deployment
III	Economic	
II.A		Project Assessment

Parts I and III are primarily aimed at consenting authorities, regulators, and project funders, while Part II is aimed primarily at device developers and certification agencies.

There is a need to maintain consistency and clarity during the development of each protocol or guideline. So a series of high level protocols descriptions were developed to serve as templates for each of the detailed specifications, clarifying content, identifying gaps and links within the overall work programme and finally helping to maintain focus on the project's final goals. Externally the high level documents provided a mechanism for engagement with many of marine energy's stakeholders. Early feedback on the direction and coverage of the protocols was fundamental to achieving, where practical, a consensus from the diverse ocean energy community. This process was developed by WP8 and based on the practices of an international certifying agency (DNV). It was the EquiMar projects intention that the protocols should help to guide and for parts of them to be incorporated into the emerging international standards.

Indeed it is important to note that the EquiMar project does not stand alone but has been closely integrated into the National and International standardisation efforts now being undertaken. On the International level the project has a formal liaison with the International Electrotechnical Commissions (IEC) Technical Committee on Ocean Energy (TC 114), allowing the project to contribute to the debate on proposals and nominated experts for the various committees developing specific standards and technical specifications. A number of partners in EquiMar are national representatives on the International Energy Agency's Implementing Agreement on Ocean Energy (IEA-OES). At

the National level, many of the project participants are acting as experts for the working groups associated with standards committees, as well as being members of their National mirror committees for IEC TC114. Such engagement with the international standardisation efforts in marine energy was critical to the success of the project.

1.1.2 Background

The marine renewable energy (specifically wave and tidal current¹) sector is at an exciting stage with pre-commercial deployments of devices now happening in numerous regions in the world. But there has been no move towards a dominant technology, particularly with wave energy devices and, with new devices being proposed continually, evaluation and comparison of the technologies and their potential for large-scale deployment is difficult. The European Union has funded several major projects through its research and development programme in the last ten years. As well as specific projects to develop technology there have been major collaborative research initiatives; notable in these is the Coordinated Action on Ocean Energy [1], the Research Training Network (Wave Train) [2], WAVEPLAM (Wave Energy Planning and Management) [3] – “To speed up introduction of ocean energy onto the European renewable energy market, tackling in advance non-technological barriers and conditioning factors”. In 2007 the European Commission entered the latest phase of its R&D programme – the 7th Framework Programme (FP7) and announced further calls to tackle specific issues for marine renewable energy [4]. One of these was for “*Pre-normative research aiming at harmonised testing methods and comparative assessment of ocean energy converters in terms of monitoring the performance, cost, and environmental impact*”. In response to this call the EquiMar project commenced in April 2008.

EquiMar involved twenty two partners, including scientists, engineers, marine scientists and developers, from 11 countries within the European Economic Area. The partners expertise encompassed wave and tidal stream technologies, economics, the marine environment and includes leading wave and tidal stream developers. The work of EquiMar was intended to support the assessment of devices, in an equitable way, through a suite of protocols covering site selection, device engineering design, the scaling up of designs, the deployment of arrays of devices, the environmental impact, in terms of both biological & coastal processes, and economic assessment. The primary aim of the project was to develop a suite of protocols through a robust, auditable process that not only reflects the best understanding of the consortium members but also, importantly, was open to comment and contribution from external bodies. These protocols should allow

1. different technologies to be treated in an open and fair manner, and
2. matching of technologies to available sites.

They were developed by specifying best practice where possible, using current understanding and that coming from new but validated research within the project, to enable a clearer pathway for the development of marine energy (wave and tidal).

This book presents the main results from the three-year project but all of the public deliverables from the project are available to be downloaded from either the project wiki² or the project website³, many of these reports are much more detailed than the information presented here and should be consulted in conjunction with the detailed protocols presented here.

¹In the USA tidal current energy is commonly referred to as hydrokinetic energy that also incorporates river and ocean current conversion technologies. For clarity throughout this document we will discuss tidal current energy, as this is the terminology used in Europe. It is, however, important to note that both the high-level and detailed protocols are equally (and straightforwardly) applicable to all forms of hydrokinetic energy.

²<https://www.wiki.ed.ac.uk/display/EquiMarwiki>

³<http://www.equimar.org/>

Based on the practices of an international Certifying Agency (Det Norske Veritas - DNV) it is intended that the protocols should provide guidance to developers, regulators and funders and be incorporated, where appropriate, into the development of international standards. DNV has been applying its expertise in marine design and certification, gained from the offshore oil and gas industry, to marine renewable energy for several years and has produced work relating to design, standards [5] and reliability [6].

1.1.3 Deliverables

The EquiMar project has delivered a significant number of detailed reports which are available for download from the project wiki⁴. Whilst being one of the major project deliverables, this book is a synthesis of much of the information in the reports shown in Table ?? and the reader is referred to these for further information.

1.1.4 The Need

This work is timely in view of the current surge in marine renewable developments. Several nations are now developing the infrastructure to promote pre-commercial deployment of devices. Notable, in the UK are National Renewable Energy Centre (NAREC) in Northumberland and the test and standardisation work being undertaken at the European Marine Test Centre, (EMEC) in Orkney [7] where sites for the testing of both wave and tidal devices are now in operation. In the summer of 2010, a 20MW cable link was deployed to link a subsea hub to the shore at the Wave Hub site off the North Cornwall coast [8, 9]. UK developments are reflected by activity in other areas including Portugal, with the Pilot test zone [10], and Ireland where tests are currently underway at the Galway Bay site with provision for a 1:4 scale site in the West of Ireland [11]. Denmark has operated a 1:4 scale site at Nissun Bredning for some years now, for example the Wave Dragon series of tests [12]. Spain [13,14] and France [15] are also pushing ahead with offshore testing and deployment infrastructure. Turning to tidal (kinetic) current energy, at the current time the MCT turbine is installed at Strangford Lough in Northern Ireland and further testing by OpenHydro is being carried out at the EMEC test centre, in Orkney. In Canada, the Fundy Tidal Energy Demonstration Facility has been recently announced. Finally, there is the recent US Department of Energy announcement of grants to increase activity in the North West USA in Washington State and Oregon, where there is a proposal to develop a mobile test facility (site) and also in Hawaii, to facilitate the “development and implementation of commercial wave energy systems” [16].

There have been several contributions to the formulation of “guidelines and standards”. In 2004 EPRI produced an assessment of a range of wave technologies under development [17]. Annex II of the International Energy Agency report [18] makes proposals for the tank testing of devices. Researchers at HMRC Cork have proposed a process and guidelines to aid the design of marine energy converters [19,20]. In 2007, the then UK Department of Trade and Industry, published draft protocols for testing of marine devices for operation of its Marine Renewable Deployment Fund [21] (wave) and [22] (tidal). EMEC has managed the development of guidelines and draft standards in several areas [23] leading to several proposals to the British Standards Institute (BSI) for international appraisal under IEC TC 114.

In terms of developer activity there have been several notable successes, particularly with the deployment of three Pelamis devices (Pelamis Wave Power) at Agucadora in Portugal, testing of the Marine Current Turbine in Strangford Lough and the deployment of the OpenHydro device at EMEC. In the US Verdant Power have installed six grid connected turbines in the New York East River. Ocean Power Technologies has plans for deployments in Spain, the US (Oregon and Hawaii) and also at the EMEC test site in Orkney and at the Wave Hub site.

⁴<https://www.wiki.ed.ac.uk/display/EquiMarwiki/EquiMar>

Table 1.3: List of publicly available project deliverable reports

Number	Title
D1.1	Global Analysis of Pre-normative Research Activities for Marine Energy
D1.2	Recommendations from Other Sectors
D2.2	Wave and Tidal Resource Characterisation
D2.3	Application of Numerical Models
D2.4	Wave Model Intercomparison
D2.5	Tidal Model Intercomparison
D2.6	Extremes and Long Term Extrapolation
D2.7	Protocols for Wave and Tidal Site Assessment
D3.1	Identification of Limitations of the Current Practices Adopted for Early Stage Tidal Device Assessment
D3.2	Concept Appraisal and Tank Testing Practices for 1st Stage Prototype Devices.
D3.3	Limitations of Current Practices adopted for Tank Testing of Small Marine Energy Devices.
D3.4	Best Practice for Tank Testing of Small Prototype Wave and Tidal Devices.
D4.1	Sea Trial Manual
D4.2	Data Analysis and Presentation
D5.1	Guidance Protocols on Choosing of Electrical Connection Configurations
D5.2	Device Classification Templates
D5.3	Protocols and Guidance for Device Specification and Quantification of Performance
D5.4	Tested Version of Site/Device Matching Database Including Initial Analysis of Interaction Effects Within Arrays
D5.5	Pre-deployment and operational actions associated with marine energy arrays
D5.6	Assessment, reporting and remediation of risk associated with marine energy arrays
D5.7	Assessment of the present status and future scenarios of the supply chain for marine energy arrays
D5.8	Impacts Upon Marine Energy Stakeholders
D6.1.1	Existing Legislation, perspectives and evolution of other similar technologies
D6.1.2	Technical Criteria for a Common Legislation
D6.2.1	Draft Scientific Guidelines
D6.2.2	Scientific Guidelines
D6.3.1	Uncertainties Regarding Environmental Impacts
D6.3.2	Uncertainties and Road Map
D6.4.1	Draft Protocol on Life Cycle Analysis Approach
D6.4.2	Life Cycle Analysis Protocol
D6.5.1	Analysis of Case Studies and Useful Tools
D6.5.2	Analysis of Case Studies and Useful Tools
D7.1	Summary of Attributes of Cost Models used by Different Stakeholders
D7.2.1	Procedures for Economic Evaluation
D7.2.2	Dissemination of Economic Assessment Approach to Stakeholders (Summary Manuscript Presentation)
D7.3.1	Support Structures for Arrays of Wave Energy Devices Report
D7.3.2	Consideration of Cost Implications for mooring MEC devices
D7.3.3	Guidelines Regarding the Variation of Infrastructure Requirements with Scale of Deployment
D7.4	Procedures for Estimating Site Accessibility and Appraisal of the Implications of Site Accessibility.
D9.1	Report on the State of Ocean Energy in Europe: Technologies, Test Sites and Joint Projects
D9.3	Magazine Article

This brief review does not pretend to provide comprehensive coverage of all activities around the world, but is intended to demonstrate the increased international activity supporting commercial scale development and the emphasis now being placed on sea-testing and development. It is also true that there is still considerable divergence in proposed technologies, particularly wave technology. Many of these technologies will be vying for financial support (private and governmental) and also in competition for deployment sites. It is within this context that an independent methodology to provide a fair evaluation and comparison of each device's potential (in terms of their engineering quality, economic potential and effect on the marine environment) is highly desirable and has led directly to the EquiMar project.

1.2 High level protocol descriptions

To ensure consistency across the six protocols being delivered a template for a high-level description of each protocol was developed by WP8. These outline the philosophy and coverage of each protocol stating clearly the purpose of this stage of development and objectives of the protocol and providing an outline of the contents and exclusions expected from the detailed text.

The "high level" documents perform two main purposes; internal to the project, they serve as a template for the detailed specifications, assisting in consistency between documents, clarifying content and identifying the final goals; externally they were used to engage the many stakeholders within the international community and, specifically, those agencies that are currently developing standards and guidance, particularly within TC114 of the International Electrotechnical Commission and the work of the Implementing Agreement on Ocean Energy Systems of the International Energy Agency.

The "high level" documents, upon which the detailed protocols will be based, should focus on common and essential principles that may where possible be applied to the different technologies within BOTH the wave and tidal stream sector.

To explain the purpose of these high level descriptions Protocol I.A will be considered. The stated purpose of Resource Assessment is:

The assessment of the available resource should provide a sufficient description to provide (1) a high-level estimate of the available energy production, and (2) an assessment the operating and survival envelopes of a specific site.

Resource assessment is aimed at achieving an understanding of wave and tidal energy climates from which estimates of energy production can be made. A secondary requirement is to provide information for engineering design. It is expected that the end user may be interested in seasonal aspects, expected average output (in periods such as months, seasons, and years) as well as longer-term project length estimators.

To address the two distinct aspects the protocol will be subdivided into two sections, resource characterisation and site assessment, with the following objectives:

1. **Resource characterisation** – is normally carried out to establish suitable geographic locations for deployment, has the following objectives :
 - (a) To ascertain the potential resource for energy production with an explicitly stated degree of uncertainty.
 - (b) To identify constraints on resource harvesting.
2. **SiteAssessment** – is normally carried out prior to deployment, to establish the detailed physical environment for a particular marine energy project, with the following objectives:

- (c) To assess the energy production through out the life of the project.
- (d) To characterise the bathymetry of the site to an explicitly specified, and appropriate accuracy.
- (e) To ascertain the spatial and temporal variation of the resource with an explicitly stated degree of uncertainty
- (f) To describe met-ocean conditions.
- (g) To establish extreme (survivability) conditions with a defined return period.
- (h) To identify potential interference between multiple devices located at the site.

As can be seen these are generic principals and are designed to be applicable to the widest range of energy conversion technologies and deployment sites. It is important to note that the purpose and principals refer generally to the expectations of resource assessment rather than to the specific areas that will be covered by the protocol. These principals do not consider Impact Assessment, which is covered by a separate protocol (I.B). They are concerned with the development of what could be considered resource atlases (in Part 1) and specific site models (in Part 2).

One model for an appropriate resource atlas is the matching study [20] performed by the University of Edinburgh for the Scottish Government which used a combination of available wave and tidal climate data with a GIS system which embedded physical constraints into the system. This approach allows areas where for example the climate is too extreme for exploitation or, the water is too deep (or shallow), or, where there are shipping lanes and network infrastructure issues to be excluded from the atlas. It is critical however that any such atlas includes information about the uncertainty and variability of any predictions to allow long-term governmental and economic policy makers to make informed decisions.

Site assessment is likely to start with a detailed hydrodynamic model of the selected site. Although tidal currents can be interpolated from local tidal diamonds and wave climates transformed from nearby offshore wave rider buoys extreme care must be taken in doing so. In order to assess the energy production from individual machines the local met-ocean climate at the deployment position must be assessed and the effects of interactions with other machines located at the site. While it may be desirable to deploy oceanographic instruments at the specific location, it is unlikely that such a measurement campaign will be of sufficient duration to fully characterise the wave conditions at the site. As a result a combination of validated computer models needs to be used in combination with available local measurements and transformed met-ocean data, using procedures similar to those widely used in coastal engineering for establishing the design conditions for breakwaters and harbours.

For tidal currents, large-scale eddy structures in the flow are of critical importance and it is only very recently that work is beginning on measuring the oceanographic flows in sufficient detail. Many designers begin the site assessment by considering simple tidal streaming atlases but these do not provide sufficient detail of the spring and neap flow conditions to permit accurate site selection for the devices. Commonly a study using a numerical “basin” scale model will be used with hind casting to match available data from ADCP deployments within the deployment site. In contrast to wave climate assessment, oceanographic instruments can be used for tidal flow as the deployment need only be made over one or two months to obtain sufficient information to plan the deployment.

In ascertaining the local met-ocean data for a specific site it will be critical to obtain estimates of the variability of the conditions through out the life of the project and to give estimates of the uncertainty associated with such predictions. The prediction of clear weather windows for access to offshore equipment for planned, emergency maintenance, and installation and decommissioning are critical to the economic viability of a project as they will have a direct effect both on the design of the equipment to be deployed and the vessels needed. To deal adequately deal with such issues the EquiMar protocols will cover, in detail:

1. Resource characterisation
 - (a) Describe specific, tested methods for wave and tidal analysis, including methods for the quantification of uncertainty.
 - (b) Describe key parameters that should be used in discussing wave and tidal climate and their role in energy assessment.
 - (c) Provide a context for the use of numerical models in transforming the sea climate from one location to another.
 - (d) Describe a systematic approach for identifying factors that place constraints on exploitation.
2. Site Assessment
 - (e) Provide a rationale for the type, number and duration of measurements.
 - (f) Provide a context for the use of numerical and statistical models in the quantification of spatial and temporal variation of the sea climate.
 - (g) Describe methods for the assessment of operating conditions through the quantification of key parameters along with their associated variability and uncertainty.
 - (h) Describe key parameters for assessing device survivability and guidance for quantifying their extreme values and return periods.
 - (i) Describe methods for identifying device-device interactions that will affect estimates of energy production.

In all cases the assessments must be based on robust, validated methods together with measurements obtained from quality controlled instruments with data recorded over a sufficient period to be able to make reasonable estimates of the variability of the met-ocean conditions. Both local and regional assessments must provide coverage of the wind, wave and ocean current conditions prevailing in the study area as this is critical to establishing the suitability and likely performance of different technologies. Local assessments must be based on high-resolution bathymetric data and need to quantify the likely survival and operating conditions at the site. The protocols anticipate that for each assessment (either site or regional) a report will be produced that will:

1. Describe the limits of the assessment.
2. Describe the particulars of the site where the development is to be placed.
3. Describe the instrumentation used to collect site data.
4. Explain the analysis methods used in determining the potential resource and how they meet the criterion for accuracy and consistency.
5. Explain the use of numerical models in providing the resource assessment.

Finally, Model results and observation data should be archived in a robust and accessible manner for possible future re-analysis by independent third parties.

1.3 Review of Methodology and Process

The final protocols were arrived at through a process of review, engagement and synthesis. An early activity for the consortium was state-of-the-art review based on the wide experience within, and indeed outside the consortium (see EquiMar deliverable D1.1). The high level protocols became an important instrument for engagement with the international marine energy community. The presentation of a series of short documents stating principles and general content was seen to have more effect than to ask people to review unfinished documents.

1.3.1 Engagement and External Review

Although the membership of the consortium was both wide in background and deep in technical ability there was a key need to engage with the wider community. This was necessary to ensure:

- that the general aims of the project were understood;
- any *unrecognised* gaps in the topics to be covered were identified;
- the EquiMar researchers were made aware of any concerns and comments as to the structure;
- any useful comments and suggestions were received early enough in the project to be useful in guiding the final output.

It should be said that there was constant dialogue between individual researchers and the external community to inform their particular topics, however it was key that a more structured approach be taken to achieving feedback on the project. The High Level Protocols were the vehicle for this engagement.

Initial workshop: At the commencement of the project a workshop was held to run concurrently with the 2nd ICOE conference in Brest (October 2008). This workshop was to introduce the aims of the project to the wider marine renewable community.

Questionnaire: A questionnaire (see EquiMar deliverable D8.2) was developed for each of the final protocols. These were distributed to 115 named individuals for comment on the content and approach of one or more of the High Level Protocols. The range of stakeholders invited to complete the questionnaire is illustrated in Figure 1.3. As a result, responses from 17 individuals were received, including 34 completed questionnaires covering all protocol areas. The responses not only addressed the specific questions but many also included longer free-format replies. The responses were circulated to the responsible group within EquiMar for discussion and any resulting action. Often this included direct contact with the respondent to further understand the context of their response. An analysis of the responses can be found at in Deliverable D8.3.

International Workshop: Following revision of the High Level documents and commencement of work to finalise the content of the detailed protocols, the final stage in the consultation and dissemination process was an international workshop, held as part of the 3rd ICOE conference in Bilbao (October 2010). The workshop was run over two days, with an emphasis on the regulatory and economic aspects of the protocols on Day 1, and the more technical details presented on Day 2. The event was attended by 31 people on Day 1 and 46 on Day 2. Attendees heard an update of the project progress and were given specific information on the nature and content of the final protocols. Feedback was collected through feedback sheets and discussions with attendees.

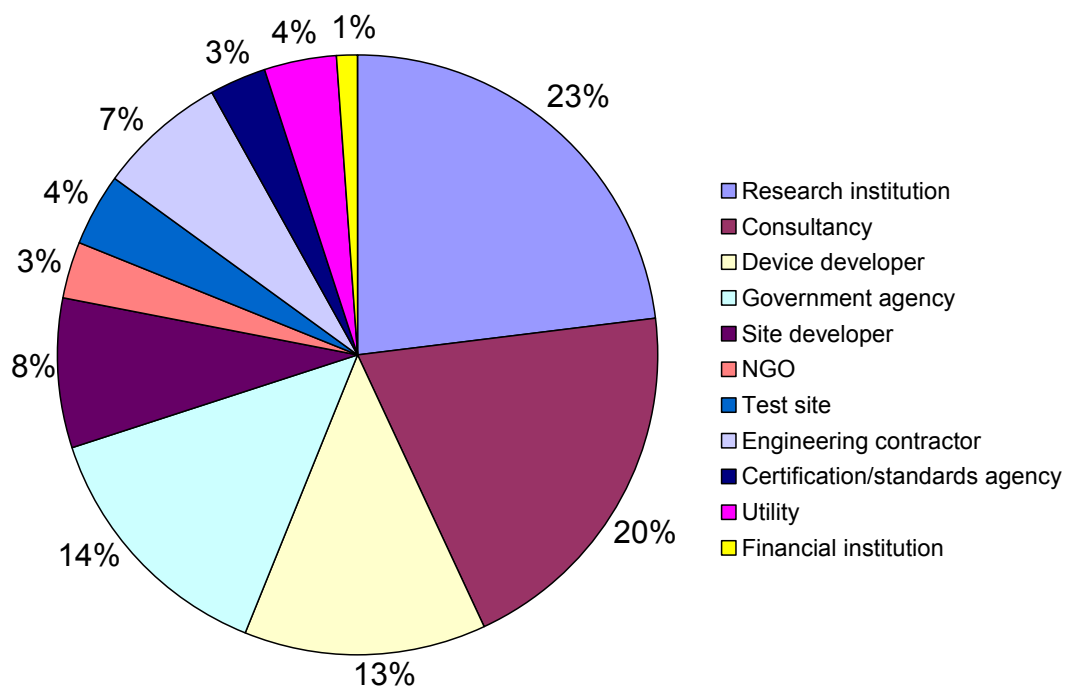

Figure 1.3: Breakdown of the 115 stakeholders invited to complete the questionnaire on the High Level Protocols

Chapter 2

The Management of Risk

Chapter 3

High Level Protocols

3.1 Resource Assessment

Protocol I.A

Purpose of Resource Assessment

The resource assessment should provide

- 1. an estimate of the available energy resource, and*
- 2. an assessment of the operating and survival characteristics of a specific site.*

Resource assessment is aimed at achieving an understanding of wave and tidal climates from which estimates of energy production can be made. A second requirement is to provide information for engineering design. It is expected that the end user may be interested in seasonal, yearly and longer-term characteristics

Objectives of Resource Assessment

Resource characterisation

— is normally carried out to establish suitable geographic locations for deployment, and has the following objectives:

- A. To ascertain the potential resource for energy production with an explicitly stated degree of uncertainty, including seasonal and inter-annual variation;
- B. To identify constraints on resource harvesting.

Site Assessment

— is normally carried out prior to deployment, to establish the detailed physical environment for a particular marine energy project, with the following objectives:

- C. To assess the energy production throughout the life of the project;
- D. To characterise the bathymetry of the site to an explicitly specified and appropriate accuracy;

- E. To ascertain the spatial and temporal variation of the resource with an explicitly stated degree of uncertainty;
- F. To describe metocean conditions to support installation, operation and maintenance;
- G. To establish extreme / survivability conditions with a defined return period;
- H. To identify potential interference between multiple devices located at the site.

Reporting from Activity

Both *Resource characterisation* and *Site assessment* should result in:

1. Analysis of the level of resource
2. Description of the limits of the assessment;
3. Description of the particulars of the site where the development is to be placed;
4. Description of the instrumentation used to collect site data;
5. Explanation of the analysis methods used in determining the potential resource and how they meet the criterion for accuracy and consistency;
6. Explanation of the use of numerical models in providing the resource assessment;
7. Model results and observation data, archived in a consistent, documented and accessible manner for possible future re-analysis.

Contents of Protocol

Resource characterisation

This section of the protocol will:

- i) Describe specific, tested methods for wave and tidal analysis, including methods for the quantification of uncertainty;
- ii) Describe key parameters that should be used in discussing wave and tidal climates and their role in energy assessment;
- iii) Provide a context for the use of numerical models in transforming the sea climate from one location to another;
- iv) Describe a systematic approach for identifying factors that place constraints on exploitation.

Site assessment

This section of the protocol will:

- i) Provide a rationale for the type, number and duration of measurements;
- ii) Provide a context for the use of numerical and statistical models in the quantification of spatial and temporal variation of the sea climate;
- iii) Describe methods for the assessment of operating conditions through the quantification of key parameters along with their associated variability and uncertainty;
- iv) Describe key parameters for assessing device survivability and guidance for quantifying their extreme values and return periods.

Exclusions

This protocol will not give guidance on Objective H. Guidance on array performance will be given in “II.C Performance of Multi-Megawatt Device Arrays”.

Principles

Resource characterisation

- Assessment of the wave/tidal resource should be based on robust, validated methods.
- Existing field measurement data from quality controlled instruments recorded over a significant duration should be used wherever possible.
- Distant environmental conditions should be transformed to local conditions using established and recognised transformation techniques.
- Error analysis should be performed to quantify the degree of uncertainty associated with any predictions.
- Constraints on the extraction of the resource must be identified.

Site assessment

- Appropriate bathymetric surveys should be available for the whole of the deployment site.
- The local metocean conditions for the site must be established including wave, wind and currents.
- The operating and survival conditions at the site should be quantified with specified accuracy and return periods.

Key Aspects

1. Measurement

- The principles, operation and limitations of the measuring system should be explained and uncertainties stated.
- The operational aspects of the measurement regime shall be described and shown to meet the accepted degree of uncertainty.
- The results should be reported in such a way that the key parameters are highlighted along with an estimate of the associated uncertainty.

2. Numerical Modelling

- The principles, operation, limitations and assumptions of the model should be explained and uncertainties stated.
- The sensitivity of the model to input conditions should be established.
- The methods for validation of the model should be explained.

3. Analysis

- Analysis techniques should be consistent and robust over a variety of wave and tidal climates.
- They should be shown to meet the required accuracy.
- They should be repeatable by an independent external auditor.

3.2 Environmental Assessment

Protocol I.B

Purpose of Environmental Assessment

An environmental assessment is performed to understand and evaluate the potential environmental effects of a marine renewable energy project and to promote the sustainable development and implementation of ocean energy projects. The assessment should be used by stakeholders and consenting or regulatory bodies to inform the decision making process from concept to decommissioning.

Objectives of Environmental Assessment

An environmental assessment of a marine renewable energy project should be conducted to:

- A. Identify, predict, evaluate and classify the potential environmental and socio-economic impacts (beneficial and harmful) from concept to decommissioning;
- B. Recognise and evaluate possible cumulative impacts of the project itself and in combination with other projects and/or marine activities;
- C. Contribute to site selection by identifying significant environmental and socio-economic features of the possible deployment areas, by estimating their sensitivity to the project characteristics (baseline survey outcomes);
- D. Select appropriate mitigation measures for harmful impacts;
- E. Establish a monitoring programme for the deployment, operation, decommissioning and post-decommissioning stages;
- F. Consult with and inform stakeholder groups and the public in general;
- G. Propose and implement environmental management actions¹;
- H. Inform the project development process.

Reporting from Activity

The environmental analysis is normally reported by the results of the Environmental Impact Assessment (EIA). However, and since the environmental analysis should also be considered as a planning instrument, it would be desirable that it could form an integral part of the project development from the beginning. In this way, there are several environmental assessment techniques (SEA, ERA, LCA²) which can be consulted / applied before conducting an EIA to inform and support the decision making process of the device concept design and activities planning. The results of these complementary environmental assessment techniques / instruments can further be integrated in the EIA report. An EIA usually comprises the following phases:

- Screening, which identifies the areas of legislation under which the project falls;

¹An adaptive management process should be followed in the early stages of technology development aiming to improve the efficiency and effectiveness of the environmental assessment process.

²SEA: Strategic Environmental Assessment; ERA: Environmental Risk Assessment; LCA: Life Cycle Assessment.

- Scoping, which establishes the boundaries of the investigation, the assessments and measurements required, and any assumptions to be made;
- Baseline survey, which identifies the state of the environment at the deployment site and in surrounding areas, prior to any installation or deployment activity;
- Potential environmental impacts identification and evaluation, both positive and negative;
- Monitoring programme for the deployment, operation, decommissioning and post-decommissioning stages of the project;
- Mitigation measures, to reduce or eliminate adverse impacts;
- Consultation, with feedback from stakeholders and general public, which should feed constantly into the EIA process.

Each phase listed above comprises an active process that culminates with a report.

Contents of Protocol

The main topics of the Environmental Assessment protocol for marine renewable energy projects (wave and tidal) will cover:

1. Planning and management of the environmental assessment

- i) Scope and appropriateness of the environmental assessment (Fig 3.1)
- ii) Context and timing for the application of environmental assessment techniques to marine renewable projects:
 - a. Strategic Environmental Assessment (SEA)
 - b. Environmental Impact Assessment (EIA)
 - c. Environmental Risk Assessment (ERA)

2. Baseline characterisation of environmental components

- i) Principles for the assessment of environmental and socio-economic reference conditions
- ii) Principles for the evaluation of the environmental sensitivity of a site
- iii) Methods for data gathering and analysis
- iv) Integration of the Strategic Environmental Assessment

3. Potential impacts and mitigation options

- i) Types of environmental and socio-economic impacts
 - a. Prototype (single devices)
 - b. Large scale projects (farms)
- ii) Mitigation measures and benefits gained
- iii) Information gaps and issues for future research

4. Tools for identification and evaluation of impacts (including risk assessment)

- i) Assessment matrices
- ii) Checklists

- iii) Mathematical modelling
- iv) Geographic Information Systems
- v) Prioritisation of impacts - environmental risk assessment
- vi) Other tools

5. Guidance on monitoring methodologies

- i) Purposes of environmental monitoring
- ii) Monitoring planning
 - a. Monitoring during installation / decommissioning
 - b. Monitoring during operation
 - c. Monitoring after decommissioning
- iii) Case studies

6. Public participation

- i) Objectives
- ii) Identification of target audience
- iii) Techniques
- iv) Conflicts
- v) Incorporation of results in decision making

Exclusions

Most marine energy projects are likely to include land based works, and some may have significant impacts on-shore due to equipment installation or infrastructures that support marine devices deployment. Such works will need to be considered in the environmental assessment but will not be addressed within these protocols.

Principles

Planning and management of the environmental assessment

- The scope of the environmental assessment is intended to be as shown in Fig. 3.1;
- The environmental analysis should be conducted in order to identify, describe and evaluate specific aspects of device design and supporting activities that need to be subjected to detailed environmental scrutiny at all stages of device deployment, from concept to decommissioning;
- The environmental assessment planning should also include an extensive review of the political, legal and maritime spatial planning framework in existence at any potential project site (Strategic Environmental Assessment);
- The environmental assessment planning should allow continuous reappraisal and adjustment practices, in order to meet the desired outcomes (adaptive management actions);

Baseline characterisation

- The baseline characterisation should describe a systematic approach for identifying environmental and social factors that may affect site selection.

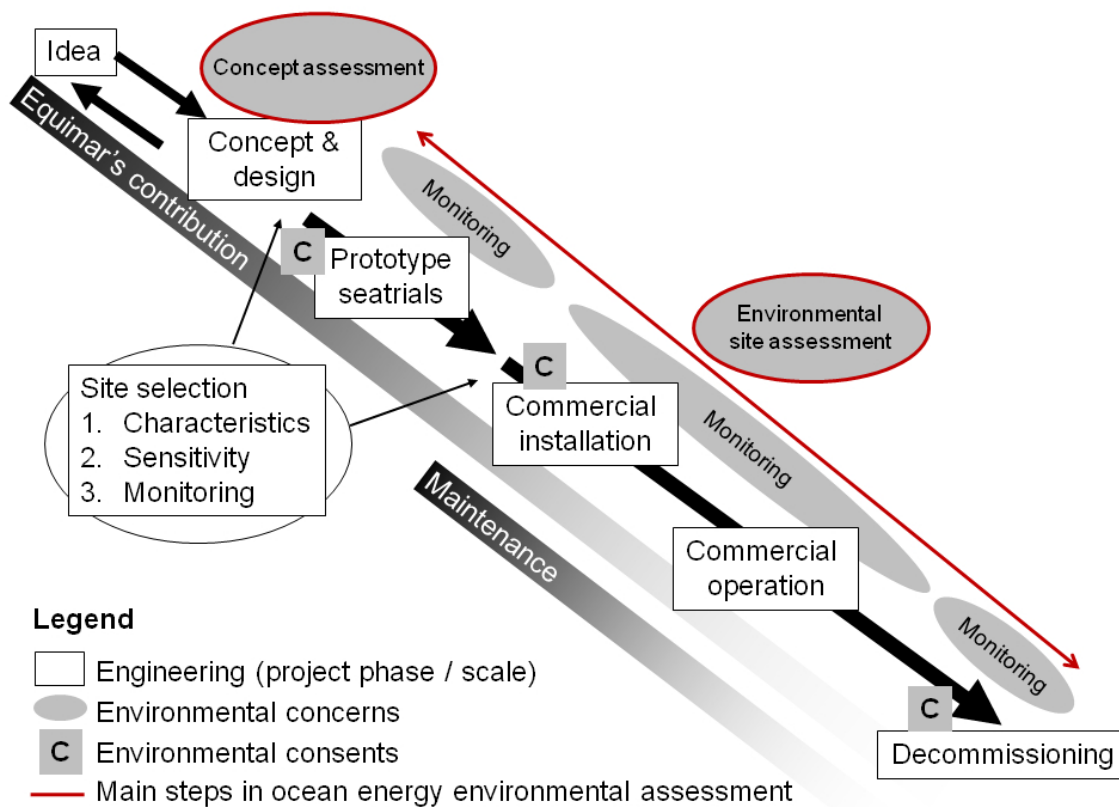

Figure 3.1: Scope of the environmental assessment: wave and tidal project phase sequence and environmental concerns during the process.

- It should provide a rationale for characterising the sensitivity of a site that will affect the extent and variety of data gathering from the site.
- It should describe the key aspects of the receiving environment that should, as a minimum, be considered in environmental assessment of a site (including environmental, commercial and leisure uses).
- All data gathering should utilise any established protocols that are appropriate to the site and should show variability (seasonal and inter-annual) so that subsequent monitoring can demonstrate any significant environmental effects.
- Particular attention should be paid to environmental characteristics that correspond to the risks identified for the designs under consideration.
- Any amendments to generic protocols required to deal with site specific issues should be based on expert advice, taking full account of the analytical framework within which the data collection is nested.

Potential impacts prediction and mitigation options

- The physical constraints of device design on marine biota must be identified and, where appropriate, minimised at the design phase;
- The generic and critical uncertainties of the device's environmental effects that require further basic research should be identified;
- The list of the potential environmental and socio-economic impacts in a specific site

should be prioritised³

- Life Cycle Analysis should follow the standardised process established by the International Organisation for Standardisation (ISO, 14000);
- The selection of mitigation measures should give priority to avoidance of impacts, then minimisation and finally restoration;

Monitoring

- Monitoring should quantify the presence and extent of key impacts of the device deployment and supporting activities on the identified environmentally sensitive issues.
- It should take into account the natural temporal and spatial variability of the site;
- It should be performed throughout device installation, operation, decommissioning and post-decommissioning periods during prototype sea-trials and commercial operation scales in line with recommendations from regulators and current state of knowledge regarding specific potential impacts.
- The monitoring plan should follow an adaptive management process in order to identify and respond to uncertainties regarding the project's effects.
- The monitoring plan should provide a rationale for the type, number and duration of measurements according to the key environmental aspects identified in the baseline survey; where possible, reference protocols or methods/ instrumentation should be used.
- As for the baseline survey and wherever possible, data gathering should utilise any established protocols that are appropriate and should show variability (seasonal and inter-annual) in order to evaluate potential environmental effects.
- An assessment should be performed on the interference of multiple devices on the receiving environment to establish appropriate array spacing and assist the design of the final deployment arrangement.
- Data analysis techniques should be considered before data collection procedures are chosen.
- The results should be made available to stakeholders and, wherever possible, to other developers.
- Monitoring should provide a context for the use of numerical and statistical models in the quantification.

Key Aspects

The protocols to be produced should be a balanced approach between scientific, legislative and industry interests in order to optimise effort. Since the industry is still in an early stage and few case studies are available, there is still a large degree of uncertainty regarding what environmental impacts will result from deployments. The protocols that will be delivered should therefore be considered as guidance or best practice according to the experience available to date. Where possible, information gaps will be identified in order to enable the protocols to evolve as understanding of impacts improves. The concept of adaptive management, which is stressed throughout the document, also encourages the methodologies to be modified/improved as knowledge progresses.

³The importance of different risks is closely tied to the site chosen.

3.3 Tank Testing

Protocol II.A

Purpose of Tank Testing

Tank testing is performed to obtain high quality data for a proposed device under a controlled environment. Estimates of final performance may also be obtained against a selection of idealised sea conditions. Tank Testing includes small scale through larger scale model testing including preliminary analysis of power takeoff.

Objectives of Tank Testing

Tank testing, typically carried out early in the development programme, has the following objectives:

- A. To characterise the performance by investigating the behaviour of the device under controlled conditions in order to confirm device operation and calibrate analytical models and software;
- B. To investigate the impact of different configurations, dimensions and other component changes on device performance and survivability. This earlier stage testing leads to a better understanding of the critical parameters influencing device performance and identifies parametric sensitivities within analytical models;
- C. To establish an early indication of the technical feasibility of the concept with respect to the behaviour of the device, energy conversion capabilities and identification of any potential show-stoppers’;
- D. To use the screening of the different configurations and the improved simulation tools from small scale testing to focus the main studies on the larger scale models. This will allow for the behaviour of the energy converter to be modelled more accurately, whilst still in a controllable environment and with reduced costs. Some parameter sensitivity studies are possible.

Reporting from Tank Testing

Reporting from Tank Testing will cover three areas:

1. Scope of the test
2. Report on the test
3. Post test evaluation

The *Tank Testing* scope needs to be clearly defined by a test specification that should define the following:

1. The areas of uncertainty and novelty that are to be addressed during the test;
2. The tests to be performed, including the range of hydrodynamic excitation, the model physical and control parameters and any modifications to the model, and the goal of the tests with respect to elucidating model performance and behaviour;

3. Required minimum qualification of tank testing to satisfy the range of tests to be performed, compatible with the model scale and objectives of the test;
4. Reporting requirements, i.e. content and parameters to be reported;
5. Required Certification of Tank Test;
6. Requirements for traceability of results, storage of results and integrity of data.

The Tank Test reporting should:

1. Define the objectives of the test, how the objectives have been achieved considering the scope of the test, any limitations with the test tank facility, instrumentation and level of accuracy of the conclusions derived by the testing;
2. Describe the implications of the model scale effects used regarding the objectives of the test;
3. Define the roles of the device developer, test tank facility and any independent third party if involved;
4. Describe the test carried out including: model characteristics, facilities, sea states/flow conditions implemented and the reasons for their selection, equipment used for measurements and the data processing and presentation techniques adopted and associated inaccuracy, description of the parameters to be monitored and the reasons for their selection, recommendations for next steps;
5. Define the status of the product development, for instance first trial prototype, pre-commercial pilot, commercial qualification, etc;
6. Report the target of the tests, for instance first trial, preliminary result, result for R&D only, data to be made commercially available;
7. Define the conditions under which data was monitored. These should:
 - (a) Reflect the setup and settings of the measurement during the tank tests and limitations (directionality, parameters not tested);
 - (b) Consider the parameters influencing the initial assessment of power capture performance identified in this protocol. In the case that any parameter is not relevant to the application, justification should be provided on its use and the principles listed above applied.

Post Tank Testing Evaluation/Reporting:

1. Report on the device performance data
2. Comparison with model predictions

The results of the Tank Test should be compared to the predictions of the analytical model and reporting on the differences and recommended modifications / calibration of the analytical model should be discussed and reported. Further tests and recommendations regarding improvements and possible modifications on the configuration of the device should be considered.

It is possible that some concepts may need to deviate from the best practices given here. However, the deviations should be documented and should be in compliance with the principles given above.

Contents of Protocol

1. Specification

- i) Determination of appropriate model scale

- ii) Assessment of physical scaling effects
- iii) Appropriate test matrix for assessing performance
- iv) Regimes for extreme conditions

2. Measurement

- i) Rationale for the type, number and duration of the measurements.
- ii) Establishment of at what point in the power conversion chain measurement of power production should be ideally performed, and the consequences/measures to be taken if it is performed elsewhere.
- iii) Provisions for data archiving to ensure traceability and repeatability
- iv) Guidance on data quality assurance procedures data

3. Analysis and presentation of results

- i) Appropriate techniques for data processing including the generation of summary statistics and estimates of uncertainty

4. Power performance

- i) A procedure for displaying the performance of the device
- ii) Equitable methodology for assessment of performance at the primary interface
- iii) Procedures for determining the optimal loading condition under a range of test conditions
- iv) Provide guidance on the normalisation of power performance assessments

5. Model Verification

- i) Procedures for verifying mathematical models

Exclusions

This protocol will not provide guidance on physical power take-off system performance.

Principles

- The selection of device scale and wave and flow conditions to be emulated within the test programme should be compatible with the capabilities of the test tank facility and correlate to realistic operating conditions.
- The tests must be documented to a level of detail that allows traceability of the results, identification of any limitations on a statistical basis, and quality of data capture and processing and/or any other aspect to be discussed including any impact on the conclusions of the tests and recommendations.
- The level of detail, complexity and reporting is expected to increase as the scale of the model is increased. In some cases, the aspects investigated are expected to shift from parametric evaluation and performance improvement to definitions of system survivability, power generation, and interaction of power take-off with the structural/hydrodynamic response.

- Tank testing results leading to the definition of mathematical models which can be used to dimension the different system components of a device must be independently verified.
- Measurements should be sufficient to allow for calibration/verification of mathematical models in order to ensure that such models are also able to predict, with a reasonable level of certainty, the power levels for different metocean conditions and site characteristics from those investigated. The levels of accuracy need to be stated and considered in the final calculation of power production.
- The main parameters investigated for power production measurements are to be identified and described. Sensitivity tests should be considered to cope with uncertainty on tank test measurements, power take-off settings and the influence of different power take-off systems.
- Any extrapolation of results should be clearly identified and will need to be based on trends manifested during measurements and levels of accuracy evaluated, and included in the conclusions and recommendations derived from such tests.
- Reference should be made to any limitations on the measurement or data processing techniques or conditions investigated that may affect the overall power production calculations.
- An independent party should be allowed to monitor any tests for which the purpose is certification.

3.4 Sea Trials

Protocol II.B

Purpose of Sea Trials

To conduct a set of trials in an uncontrolled ocean environment that build confidence in the functionality, maintenance, operation and performance of the device and its ability to survive extreme conditions.

Objectives of Sea Trials

Sea trials, normally carried out at the prototype stage, have the following objectives:

- A. Demonstration of system integrity and viability of technology;
- B. To seek for aspects that had not been identified during the previous project phases and to gain experience;
- C. Establish controllability;
- D. Gain operational experience;
- E. Calibration of analytical/mathematical model from data from prototype at sea;
- F. Early indication of availability of systems considering degradation mechanisms and maintenance routines;
- G. Establish power conversion capabilities.

Reporting from Sea Trials

The power performance statement should:

1. Define the status of the product development;
2. Define the state and target of the tests, for instance first trial, decommissioning, preliminary result, result for R&D, data to be made publicly available, etc.;
3. Describe the conditions under which data was monitored;
4. Describe the setup and setting of the measurement and control system including level of accuracy of measurements, what parameters are critical and the level of accuracy of the measurement, control philosophy and version, areas not covered during the period of sea trials and limitations (directionality, parameters and variables not observed during sea trials);
5. Consider the parameters influencing the power performance and identified in this protocol. In the case that any parameter is considered not relevant to the application, justification should be provided and the principles listed above applied.

It is possible that some concepts may need to deviate from the best practices given here. However, the deviations should be documented and should be in compliance with the principles given above.

Contents of Protocol

1. Measurements

- i) Rationale for the type, number and duration of the measurements
- ii) Provisions for data archiving to ensure traceability
- iii) Guidance on statistical quality assurance procedures for data

2. Analysis and presentation of results

- i) Appropriate techniques for data processing including the generation of summary statistics and estimates of uncertainty

3. Power performance

- i) Equitable methodology for assessment of performance through the power chain

4. System integrity and functionality

- i) Guidance on establishing and demonstrating system integrity
- ii) Guidance on the collection of data for monitoring the operation and degradation of the device and its components

5. Model validation

- i) Procedures to validate previous physical test results
- ii) Guidance on validating mathematical models

Exclusions

This protocol will not give guidance on Objective D. (Gain operational experience).

Principles

1. Power performance

- Measurements should be sufficient to allow for calibration of an analytical model in order that the analytical model should also be able to predict, within a reasonable level of certainty, the power production for different metocean conditions and site characteristics from those investigated. The level of accuracy needs to be stated and considered in the final calculation of power production.
- The main parameters investigated for power production measurements are identified and described from the point of view of the device application. System identification test protocols should identify these main parameters. This might require periods with control configurations which result in sub-optimal performance to provide information resulting from different parameter settings.
- The period of time dedicated for evaluation of power production should be defined to allow for the relevant metocean conditions to be recorded and provide the necessary statistical data. The impact of the duration of evaluation should be considered in the power calculations.

- Extrapolation of results should be based on trends manifested during measurements and the level of accuracy evaluated and included in the power performance value.
- Reference should be made to any limitations on the measurement process, field characteristics, metocean measurements at site and level of uncertainty that may affect the overall power take-off calculations. The level of availability assumed and quality of output should also be referred to, see *I.A Resource Assessment* for reference.
- An independent party should be allowed to monitor any test for which the purpose is certification.
- The power production should, where possible, be recorded at the various conversion steps from wave to wire, in order to enable evaluation of the losses at the different steps.

2. Temporal and spatial test site considerations

Refer to *I.A Resource Assessment* for further details.

- Sources of resource data for test sites should be quantified (fixed facilities and independently chosen locations), and the quality of available data appraised.
- The minimum level of characterisation of the resource at the test site for good quality validation of device power performance will be assessed, including quality, frequency, accuracy, spatial coverage and time period of measurements

3. Monitoring of system integrity; survivability

- Device specific sub-system monitoring should be performed to ensure high availability from marine energy device (based upon device classification template, see *II.C Deployment and Performance Assessment of Multi-Megawatt Device Arrays*).
- Appropriate pre-deployment testing of most vulnerable sub-systems / components to minimise device failure and maximise availability will be carried out.
- A means of measuring (during sea trial) and/or predicting (pre-deployment) device survivability should be considered. It should be noted that test sites possibly have a less extreme environment than full ocean-going sites where 2nd generation devices will be installed.

Key Aspects

- At the sea trials, emphasis is given to the capacity of the unit to perform. The location where the power is measured should be consistent with the status of the test.
- It is expected that the end user may be interested in seasonal aspects, such as likely average output in periods such as monthly, seasonal, annual. The other aspects should consider demonstrated availability with due consideration of accuracy of the data obtained so far.
- Improvements will be made to the unit design with time and experience, and are connected to the amount and quality of data collected. Modification of the characteristics of the device and controls will influence the power measurements, and the revision of any power curve should follow the principles given in this protocol.
- Power performance is derived from analytical models. It is possible to focus on the impact of modifications on the power performance if analytical modelling shows

consistency with expected impact and previous assessment of the importance of the parameters modified.

- The design and preparation for sea trials should include measures to evaluate reliability (based on failure modes and risk assessment) and the aspects affecting reliability. Design, manufacturing and testing actions leading to reliability robustness should be documented.
- Development of procedures to obtain data for early indication and qualitative identification of reliability of main components influencing the performance and survivability of the device should be obtained from the sea trial.

3.5 Performance Assessment of Multi-Megawatt Device Arrays

Protocol II.C

Purpose of Performance Assessment of Multi-Megawatt Device Arrays

To deploy and operate marine energy devices in significant numbers in order to:

- 1. Generate significant amounts of power and deliver this power to electrical infrastructure on shore, and*
 - 2. Demonstrate safe processes and acceptable cost in deployment, commissioning, operation, maintenance and decommissioning of devices and their infrastructure, leading to reduced costs per device associated with an increased scale of deployment at a single site.*
-

Objectives of Performance Assessment of Multi-Megawatt Device Arrays

- A. To plan and install a large number of devices in the marine environment in order to extract energy and convey this energy to shore;
- B. To plan effective deployment and maintenance schedules such that:
 - i. The need for direct intervention is minimised in terms of number of operations and their duration;
 - ii. Where intervention is required the associated difficulty is reduced to an acceptable level;
- C. To identify the most appropriate configuration and electrical connection of devices;
- D. To optimise the energy capture of individual devices such that the efficiency of power conversion is maximised from the array;
- E. To standardise performance parameters from an array. Due to potential device interaction these will be different to those of an individual device operating in isolation;
- F. To share systems (such as electrical connections) between devices such that the costs are reduced compared to an equivalent number of individual devices operating in isolation or a smaller-sized array.

Reporting from Performance Assessment of Multi-Megawatt Device Arrays

The pre-deployment actions should:

1. Identify supply-chain bottlenecks and potential barriers to successful installation. This will break down into the following categories, each considered for land-based and marine-based actions:
 - (a) Device support structure fabrication and transportation
 - (b) Device installation
 - (c) Subsea cabling, including any device hub structure.

2. Characterisation of the key Operation and Maintenance issues that will lead to disruption, based upon a set of criteria similar but not exclusive to the following:
 - (a) Cost of operational/maintenance action
 - (b) Frequency
 - (c) Ease (weather window, availability of equipment, etc.)
 - (d) Array down-time (availability)
3. Identify the optimal electrical connection of the array to convey power to shore. Issues such as safety, power quality and reliability should be addressed.
4. Identify present data sources for quantification of marine energy resource at suitable array sites. Produce a matrix to cross compare data sources (separate for wave and tidal) to appraise the following qualities:
 - (a) Measurement source (measured, empirical, numerical simulation)
 - (b) Measurement frequency (e.g. daily, monthly)
 - (c) Spatial coverage (adequate for array energy calculations?)
 - (d) Accuracy
5. Consider previous documented evidence of device performance, flow field effects and device interaction.
6. Review the envisaged array energy capture efficiency with regard to inter device spacing. This will be coupled to the individual devices specified or rated performance parameters that may vary with position within the array.

The performance assessment should:

1. Classify wave and tidal devices:
 - (a) To aid cross-comparison of array performance and match specific devices to their optimal sites.
 - (b) To define and quantify device performance parameters
2. Address risk reporting and remediating actions taken in order to improve future array design and performance.
3. Qualitatively address the effect of the array on the surrounding resource.

Contents of Protocol

1. Pre-deployment

- i) Classification of devices according to a systematic template.
- ii) Guidance on assessing the supply chain for the devices and their installation
- iii) Guidance on determining appropriate electrical connections and the intra-array electrical design taking into account the exported power quality
- iv) Guidance on shared sub-systems
- v) Guidance on the spatial layout of the array to optimise power production and ensure ease of access for operation and maintenance

2. Performance assessment

- i) Assessment methods for a systematic approach to quantifying performance parameters for

- (a) individual devices within the array
- (b) whole array performance
- ii) Systematic approach to the recording and reporting of temporal information including device performance, service and inspection logs and reliability data

Exclusions

- i) Marine spatial planning considerations for large-scale deployments
- ii) Permitting issues.
- iii) Operation and maintenance issues will not be covered in detail as they are highly device-specific in nature.

Principles

1. Pre-deployment actions

- The parameters affecting the requirements from the supply chain should be identified with regard to their impact on full deployment of all devices in an array within an acceptable timeframe. The appropriate time in the development of the design to do this should also be identified.
- Options for installation of different types of device configuration (mooring configurations or other configuration fixing the device in an array) should be identified, and the most efficient ways of using the equipment should be discussed with the aims of reducing time required for installation of whole arrays and impact on ultimate cost of energy.
- Barriers to successful and timely installation should be identified and ranked in order of disruptiveness. Remediating measures should be specified.
- The output from previous studies (tank tests, sea trials) should be used to identify the best configuration for the farm in terms of positioning of and distance between units while considering full-scale issues such as installation and access to the array.
- The factors influencing the choice of electrical configuration of the devices such as the number of devices and distance to shore should be discussed.
- Appraisal/Comparison of existing metocean resource data (measured, simulated, historical, etc.) available for a typical array site should be critically analysed.
- Quantification of expected accuracy/ability to extrapolate short term/limited data sets for the prediction of long-term energy yields should be performed accompanied with method description and justification.

2. Performance Assessment

- The data required from previous stages for an assessment of the minimum maintenance requirements of an individual device should be identified. The method of extrapolating and applying this data to plan the most effective maintenance regime for the farm should be defined.
- The method of applying the data from the site assessment to the power performance predictions from the tank tests and sea trials to produce a power output prediction for the array should be defined.
- The method of estimating the overall availability of the array should be discussed.

- Continuous data collection on the metocean resource of the area of deployment (see *I.A Resource Assessment*) should lead to reduction of uncertainties on the resource expected in the site. The data should be compared with earlier evaluation for re-assessment of the expected power generation for the farm.
- Device interaction and interference should be monitored considering sea states close to the boundary and within the array. Power generation and loading forces of individual devices should also be measured.

Key Aspects

1. Early arrays are likely to be composed of less than 10 devices aligned in a linear manner perpendicular to the incoming resource direction (if device performance is dependant upon resource direction) or possibly a geometric pattern (if not directional). The size of arrays, the degree of interaction between devices and general complexity of arrays will increase over time.
2. The influence of a marine energy converter upon the local spatial flow field will vary between different types of devices and also with the nature of the incoming marine resource. Therefore array design and layout is expected to be device specific.
3. As technology improves and new equipment is developed the manner in which arrays are designed and operate will invariably change. It is possible that quantitative aspects of this protocol may then require amendment. Where possible, qualitative recommendations will be given to avoid this.
4. When a device is positioned within an array and is subjected to interaction effects, the inflow of energy from the marine environment will differ to that of other devices within the array. Thus an available resource will exist and is likely to be different for many of the devices that compose the entire array. Differentiation between this available resource to individual devices and the inflow resource to the total array will be a key aspect to understanding array performance.
5. The nominal performance metrics of devices such as rated and cut-off power generation are likely to be redefined throughout an array due to the issue raised in (4) of available device resource. Methods to standardise this will aid array performance quantification but it is acknowledged that device performance metrics are presently defined by the device developer and thus standardisation of all arrays may be difficult at this time especially considering issues raised in (2) and (4) above.
6. The factors affecting site selection (including requirements for maintenance, distance to shore, and probable power output) should be discussed.
7. Collection of data should separate the early stage reliability problems from the long term and degradation issues affecting reliability
8. Mean time to failure/essential maintenance for key components/sub-systems should be estimated. Methods for extending these time periods should be explored.
9. Device interaction and interference should be monitored considering the sea state at the farm, power generation and the loading response of devices. The level of monitoring, i.e. current, waves, wind between devices, condition monitoring of a few devices (how many devices to be monitored), etc. should be defined based on the criticality of monitored parameters, level of uncertainty and the urgency that the conclusions should be derived.
10. The duration of monitoring should be based on the minimum required statistical basis. Associated uncertainty should be defined and reported.

3.6 Economic Assessment of a Marine Energy Project

Protocol III.A

Purpose of Economic Assessment of a Marine Energy Project

Economic assessments are conducted by utilities and investors to identify the technology and layout for a site that satisfies a stated set of investment criteria.

Objectives of Economic Assessment of a Marine Energy Project

Typically a number of project designs will be available and the objective of a project assessment is to identify the marine energy project design which, subject to levels of uncertainty consistent with the project and technology development stage, satisfies the specified investment criteria. To achieve this it is necessary to:

- A. Quantify expenditure over the project life;
- B. Quantify revenue over the project life;
- C. Calculate economic indicators to compare to specified criteria;
- D. Identify risks associated with the project and assess their effect on the economic indicators.

Reporting from Economic Assessment of a Marine Energy Project

The output of *Economic Assessment of a Marine Energy Project* should be a report on economic viability including:

- 1. Statement of the economic indicators;
- 2. Statement of major capital cost components;
- 3. Statement of major contributions to annual expenditure including planned and unplanned maintenance activities;
- 4. Statement of expected project revenue;
- 5. Statement of methods used to quantify risk;
- 6. Statement of method used to determine transmission costs.

Contents of Protocol

This protocol will provide a methodology for assessing the economic viability of a marine energy conversion project. The objective of the protocol is to define a procedure that can be followed by a technology developer to obtain an economic assessment that is directly comparable to that produced by any other developer. The protocol will enable comparison of two different technologies at a site or a technology at different sites. The user of economic assessments provided by several developers can therefore be confident that alternative project proposals are comparable.

1. Capital cost - Methodology**2. Operating cost**

- i) How operation and maintenance costs are likely to scale
- ii) Indicative ranges of typical units (such as vessel day rates, waiting on weather allowances)

3. Revenue - Methodology**4. Risk Assessment**

- i) Explanation of methods used to determine uncertainty of costs and quantities
- ii) Summary of typical high-risk cost elements

5. Performance and revenue

- i) Economic assessment methodology

Exclusions

This protocol does not include:

- i) Methods for determining electrical output for a technology (see *Revenue* below)
- ii) Unit costs (in terms of e.g. GBP or EURO) for particular components. These must be obtained from appropriate suppliers as required.
- iii) Methods for estimating the change of unit energy costs due to accumulation of experience or other mechanisms. An indication of the possible improvement of unit energy costs could be obtained by specifying predicted component costs to estimate capital and operating costs.
- iv) Cost of electrical transmission from site to shore. This is assumed to be independent of the generating technology.

Principles

The economic assessment of a marine energy project should include the following four stages:

1. Capital Cost

- The level of detail and margins should be compatible with the level of development of the device and assumptions clearly stated with indication of the basis for the likely cost and margins assumed.
- The cost components that are included should represent the major fraction of the total capital cost of the project.
- All expenditures prior to project commissioning should be considered including (but not limited to) fabrication, preliminary works, commissioning, deployment and decommissioning.
- Any capital expenditures required to provide the minimum maintenance scenario (as specified to obtain the device availability and power generation assumed in calculation of revenue) should be considered.

- The quantities and unit costs of all included components should be stated.
- The quantities employed should be consistent with those employed in the LCA, see protocol “*I.B Environmental Assessment*”.
- For all unit costs, the confidence in the values used and possible range should be stated to allow identification of high risk costs (see *Risk Assessment*).
- The cost of transmission infrastructure from site to shore obtained by an appropriate method should be included.
- The elements associated with capital cost should consider margins reflecting the uncertainties in the information and data used.

2. Operational Cost

- The method used to estimate operating costs should:
 - a. Clearly define the planned maintenance activities for the technology;
 - b. Account for all planned and unplanned maintenance activities that are required to provide the availability and device performance employed in the power generation calculation (see *Revenue* below);
 - c. Include all ongoing costs including (but not limited to) insurance, lease and management that must be incurred to provide the availability and device performance employed in the power generation calculation (see *Revenue* below);
 - d. Include costs associated with environmental monitoring activities (see “*I.B Environmental Assessment*”).

3. Revenue

- The method used to estimate revenue from the marine energy project should be derived from device performance and the value per unit of electricity. Electricity output should be calculated based on:
 - a. Site metocean conditions according to the criteria specified in “*I.A Resource Assessment*”;
 - b. Calculations of device output according to the criteria specified in “*II.A Tank Testing*”, “*II.B Sea Trials*” and “*II.C Performance Assessment of Multi-Megawatt Device Arrays*”;
 - c. The generator availability that is obtained by the maintenance strategy considered under *Operational Cost*.
- The revenue per unit (€/kWh) is not explicitly stated in the protocol. The user should employ appropriate values to account for:
 - a. The market value of electricity over the operating life of the technology appropriate to the predictability of power output and site location under consideration;
 - b. Additional incentives appropriate to the site location under consideration.

4. Risk Assessment

- The risk assessment should:
 - a. Define the conditions under which the economic assessment is valid;
 - b. Reflect the uncertainties associated with each component of the capital cost and operating cost of the project;

- c. Reflect the uncertainties associated with each cost element of the capital cost and operating cost of the project;
- d. Be conducted to a level of accuracy consistent with the development stage of the technologies used;
- e. Identify factors (or scenarios) that could change the outcome of the economic assessment;
- f. Reflect the financial structure of the project.

Key Aspects

Economic assessment of a project should:

- Identify the underlying factors which could significantly affect the economic viability of a project;
- Identify all significant expenditures and revenue streams;
- Account for the risk and uncertainty associated with both the inputs used and the assessment process to a level appropriate to the technology development stage, confidence in the inputs and metocean conditions used.

Part II

Detailed Protocols

Chapter I.A

Resource Assessment

Dr Vengatesan Venugopal, University of Edinburgh, United Kingdom,

Dr Thomas Davey, University of Edinburgh, United Kingdom

Dr Helen Smith, University of Exeter, United Kingdom

Prof George Smith, University of Exeter, United Kingdom

Prof Luigi Cavaleri, Consiglio Nazionale delle Ricerche: Istituto di Scienze Marine (CNR-ISMAR), Italy

Dr Marc Prevosto, Institut Franais de recherche pour l'exploitation de la mer (Ifremer), France

Dr Franoise Girard, Actimar, France

Dr John Lawrence, European Marine Energy Centre, United Kingdom

Mr Brian Holmes, Hydraulics and Maritime Research Centre, University College Cork, Ireland

I.A.1 Introduction

I.A.1.1 Need for resource assessment

Resource assessment should provide

- A quantified estimate of the available energy resource;
- An assessment of the operating and survival characteristics of a specific site.

There are three main drivers for wave and tidal resource assessment for marine renewable energy developments:

- The Energy Resource:* A primary focus is to ascertain the level of resource, at an appropriate level of confidence, through the development of a project. This information will provide the basis for a specification of power produced over the length of the project. This information will be necessary to *device developers, investors, utilities and government (both national and local)*.
- Engineering Design:* Although the major design considerations for any device will be predetermined it is probable that individual sites may require adaptation of the base design. Certainly, issues of wave and current loading will have to be considered on a site-by-site basis (e.g. for the design of the moorings). This information will be necessary to *designers, constructors, insurers and “classifiers”*.
- Marine Operations:* For a fully operating project the wave/ wind and tidal characteristics are necessary to define the installation & maintenance strategy which for a large farm in a high energy site may be highly limiting. This information will be necessary to *designers, constructors, marine contractors, insurers and “classifiers”*.

A project can be broken down into the stages illustrated in Figure I.A.1 The level of assessment needed will vary with the stage of the project and the purpose of the assessment.

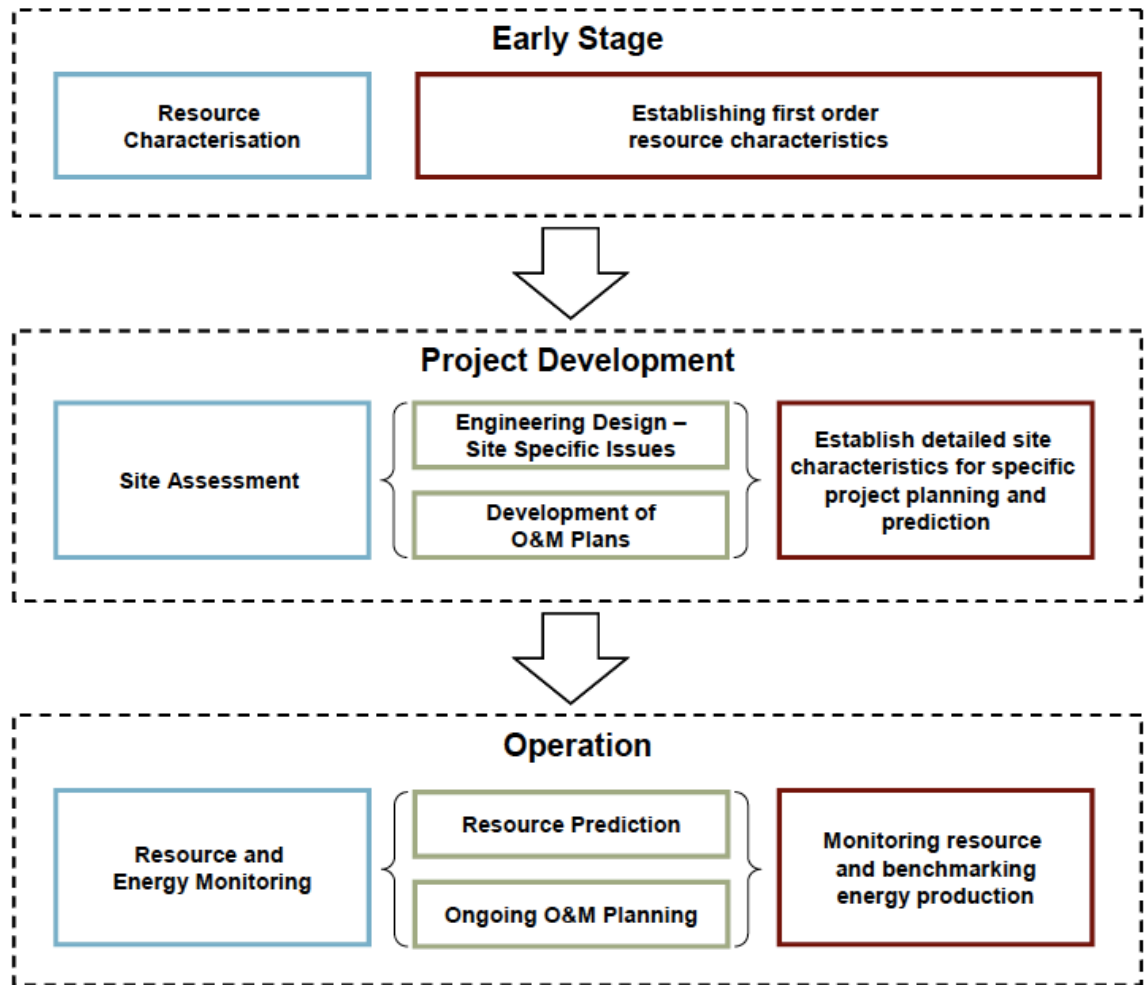

Figure I.A.1: The stages of a marine energy project, and how resource assessment will be utilised during each stage.

I.A.1.2 Scope

Resource assessment can be performed through in-situ measurements or numerical modelling. This document will give recommendations for the application of both these methods for wave and tidal renewable energy developments. This document will consider the following aspects of resource assessment:

- Measurement and raw data analysis;
- Key descriptive parameters;
- Guidance on numerical modelling;
- Assessment of extremes and device survivability;
- Identification of constraints on development at a specific site;
- Reporting.

This document will not consider:

- Potential interference and impact on resource due to multiple devices located at a site (refer to Chapter II.C for further information);
- Any aspect of environmental assessment or monitoring (refer to Chapter I.B for further information).

This document represents the contribution of 24 partners including scientists, engineers, device developers and standards agencies and has been developed from widespread international engagement. There are several other documents that cover similar issues which have been used to inform this work. For further reference please see:

- EMEC — Assessment of Wave Energy Resource, 2009;
- EMEC — Assessment of Tidal Energy Resource, 2009;
- DTI — Preliminary Wave Energy Device Performance Protocol, 2007.

Much of the background information supporting this document can be found in the appropriate sections of the following EquiMar deliverables:

- D2.2 — Wave and tidal resource characterisation
- D2.3 — Application of numerical models
- D2.4 — Intercomparison of wave models
- D2.5 — Intercomparison of tidal models
- D2.6 — Assessment of extremes

I.A.2 Wave Resource Characterisation and Site Assessment

I.A.2.1 Overview

§I.A.2 of this protocol will focus on resource assessment for wave energy developments. Figures I.A.2 to I.A.4 summarise the methods used for resource assessment at each stage of the process for a wave energy project and the intended outputs. Figure I.A.5 provides an at-a-glance summary of the methods used for wave resource assessment, the data that can be obtained through these methods, and the applications for this data.

Early stage assessment

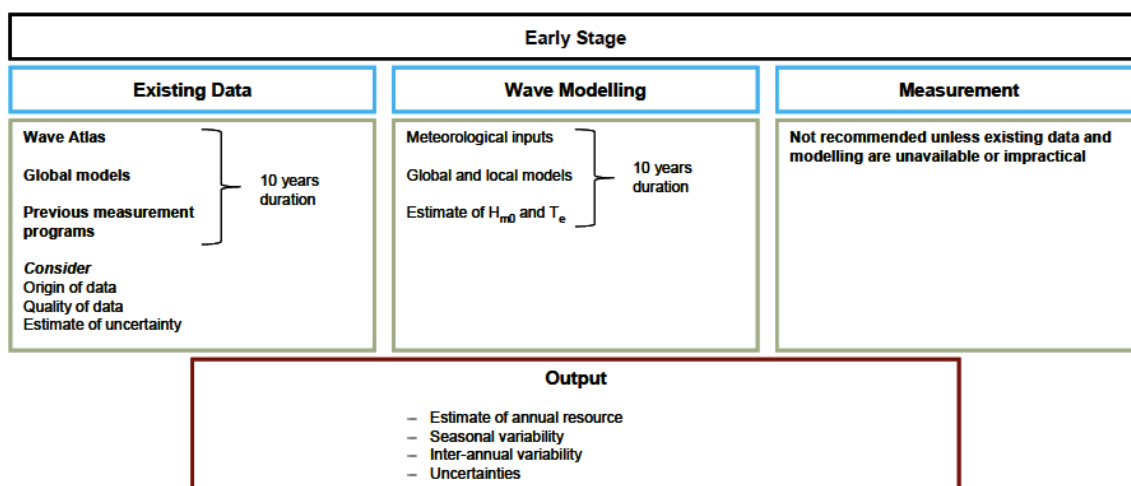

Figure I.A.2: Resource assessment for the *early stage* aspect of a wave energy development.

Early stage resource characterisation is concerned with providing a first-order assessment of the available resource over a particular area (geographic scale). This process

will primarily rely on existing data such as wave atlases and historical measurement programmes. It is recommended that a minimum of 10 years of data is used to understand the inter-annual variation of the resource. Obtaining data of this duration will usually require a numerical modelling programme to transform the output of a global model (or more rarely, a measurement programme) to the region under consideration. The output from the process is a high level estimate of the annual resource with wide spatial coverage and low spatial resolution. The process should include an estimate of seasonal and inter-annual variability. Sources of uncertainty should be identified and quantified where possible.

Project development assessment

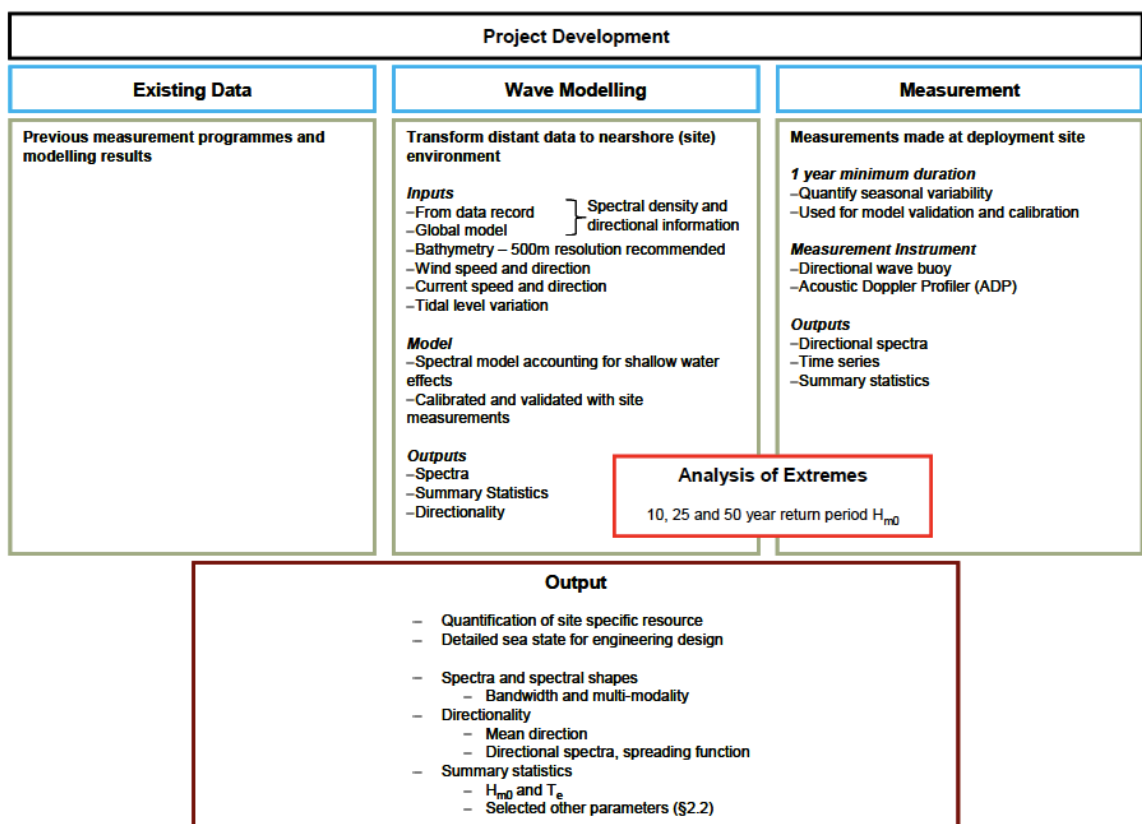

Figure I.A.3: Resource assessment for the *project development* stage of a wave energy development.

Site assessment during the *project development* stage is conducted to establish detailed characteristics at a specific site. This will typically involve a coordinated numerical modelling and physical measurement programme. The modelling programme is conducted to supply extended temporal and spatial coverage at the site through transformation of distant, reliable data. Typically this input data will be obtained from a global model or offshore measurement (if available). An in situ measurement programme will provide data to characterise the site and to calibrate/validate the numerical model. The output of the site assessment process will include a detailed characterisation of the sea states as well as high level summary parameters.

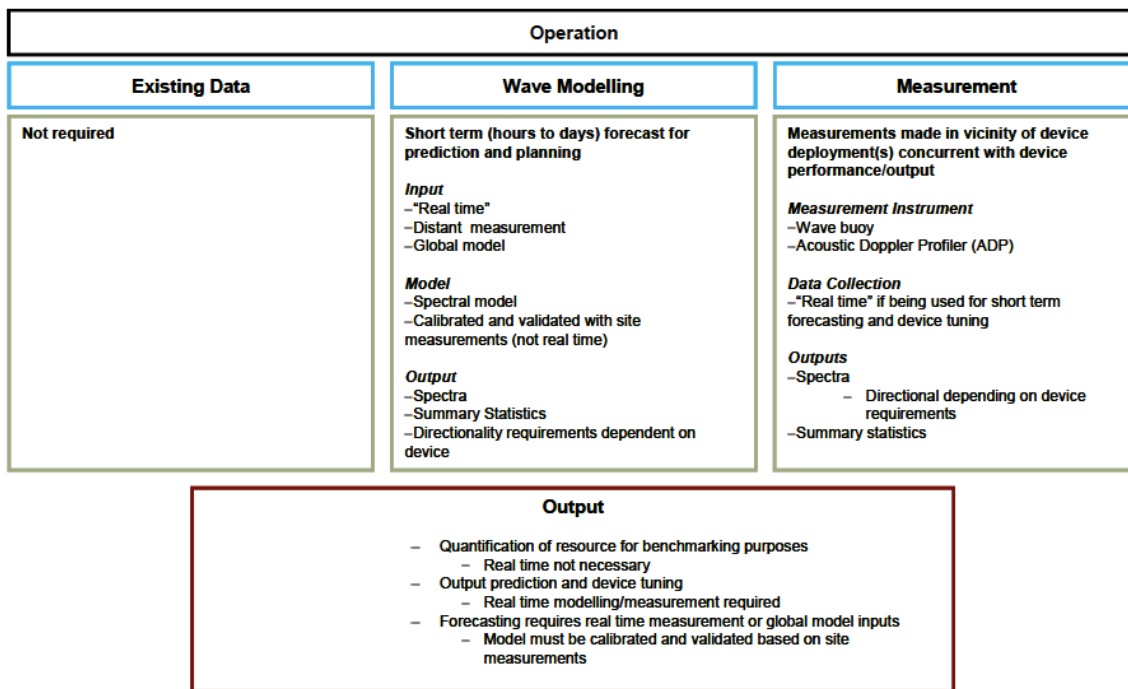

Figure I.A.4: Resource assessment for the *operational* stage of a wave energy development.

Operational assessment

The resource assessment requirements during the *operational* phase will be dependent on the specific demands of the deployment. As a minimum standard it is expected that the resource will be measured concurrently with device output and performance for benchmarking purposes. This data may also be used for device tuning purposes. If short term forecasting is required for production and management purposes a continuous modelling programme will be necessary. This model will use either offshore measurement or a global model as an input.

Assessment summary

The requirements for the *early, development* and *operational* stages of a project are summarised in Figure I.A.5. The source of this information (modelling and/or measurement) is also indicated.

I.A.2.2 Key Wave Parameters

The primary output of a wave resource assessment shall be parameters that describe the level of resource throughout the life of a project. The key parameters that should be obtained through the resource assessment are described in Table I.A.2.2 below. All parameters should be calculated through spectral analysis methods (see §I.A.3.1). Time domain analysis is not recommended for calculation of key parameters where a spectral alternative is available. The process of obtaining parameters is illustrated in Figure I.A.6.

		Modelling	Measurement	Early	Development			Operation		
				Resource Characterisation	Engineering Design	Site Assessment	Operational Planning	Level of Resource	Ongoing Operation & Maintenance	Prediction & Tuning
Summary statistics		•	•	✓	✓	✓	✓	✓	✓	
Spectra	Directional	•	•		✓	✓		✓	✓	
	Non-directional	•	•		✓	✓		✓	✓	
Elevation Time series	Directional		•		✓				✓	
	Non-directional		•		✓				✓	
Extremes		•			✓	✓				
Long-term temporal variation		•		✓		✓				
Mean and maximum currents		•	•	✓	✓	✓	✓	✓	✓	
Tidal level		•	•	✓	✓	✓	✓	✓		
Wind (model input)		•	•	✓		✓	✓	✓	✓	

Figure I.A.5: Summary of methods used and data required for resource assessment at each stage of a wave energy development.

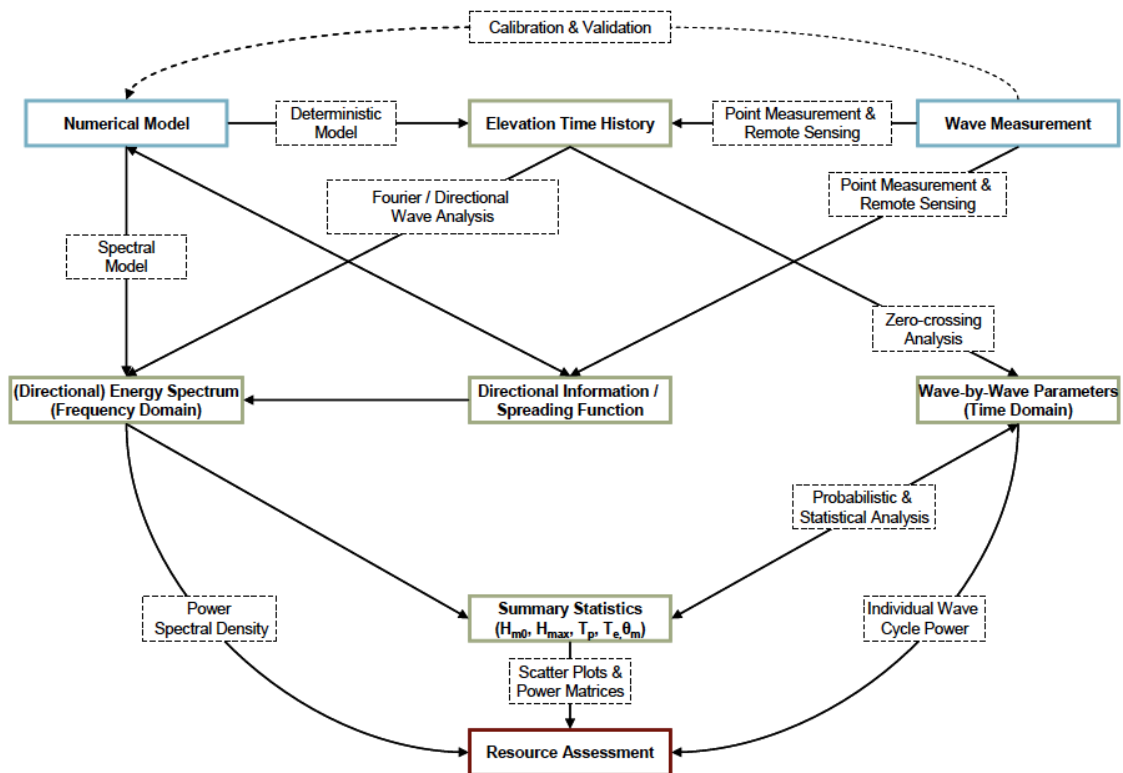

Figure I.A.6: Methods for obtaining key parameters from resource assessment

Calculated parameters

The parameters outlined in Table I.A.2.2 should be considered in a resource assessment. Those highlighted in bold shall be mandatory. These parameters have applications for:

- *Wave power level* — Accurate quantification of H_{m0} and T_e is essential for estimation of the wave power level.
- *Device performance* — Understanding the directional characteristics of the site is important for devices for which the sea's directionality influences the energy production process. It is also key to predicting array performance.
- *Quantifying the spectral bandwidth* — This allows for assessment of device production where performance across a range of frequencies is known, e.g. a sea with a narrow bandwidth will contain more energy concentrated close to the peak period).
- *Device Survivability* — Quantification of H_{m0} over an extended period of time (minimum 10 years duration from modelling) is required for the assessment of extreme operating conditions.

Definitions of the mandatory parameters in terms of spectral moments are given in Table I.A.2. See §I.A.3.1 for the method of calculation of spectral moments.

Site characteristics

The following site characteristics shall be recorded at the start of the project development stage of a wave energy project:

1. *Wind* characteristics of the site should be established through an ongoing measurement programme. Offshore measurement at the site is recommended, but shoreline measurement is acceptable if this is not possible. Output from meteorological models should be used for numerical modelling studies.
2. *Maximum current velocity* at the site shall be established through a short-term (circa 1 month) measurement programme using an Acoustic Doppler Profiler (ADP). When currents are dominated by tidal effects, tidal modelling software may be used in preference to measurement.
3. *Tidal range* at the site shall be established using measurement or tidal software.
4. *Bathymetry* at the site shall be established through a bathymetric survey (existing survey data contained in, e.g. Admiralty charts, are acceptable).

Table I.A.1: Key wave parameters obtained through resource assessment with mandatory outputs highlighted in bold.

Name	Symbol	Units	Method of calculation (§I.A.3.1)	Notes
	H_{m0}	[m]	Spectral	
Significant wave height	H_s or $H_{1/3}$	[m]	Time domain	Statistical measure of the largest wave heights in an irregular sea state. In time domain calculations, it is defined as $4 \cdot \sigma_\eta$, where σ_η is the standard deviation of sea surface elevation. In frequency domain, it is expressed as $4\sqrt{m_0}$, where m_0 is the zeroth moment estimated from a wave spectrum. H_{m0} is approximately 5%-10% larger than $H_{1/3}$ (IEC definitions). H_{m0} is fundamental in calculating power. The n th spectral moment is defined by
				$m_n = \int_0^\infty S(f) f^n df,$
				hence
				$m_0 = \int_0^\infty S(f) df$
Maximum wave height	H_{max}	[m]	Time domain	Height of the largest wave measured over a defined period of time.
Maximum crest height	Cr_{max}	[m]	Time domain	Largest wave crest height recorded over a defined period of time. Crest height is the vertical distance between the crest of a wave and the still water level.
Mean wave period	T_{01} T_{02}	[s] [s]	Spectral Spectral	A measure of the mean time between wave cycles obtained from the energy spectrum [see Table I.A.2]
Zero crossing wave period	T_z	[s]	Time domain	A measure of the mean time between wave cycles obtained from the sea surface elevation record (equivalent to T_{02})

Energy wave period	T_e	[s]	Spectral	The period of a monochromatic wave (height H) which contains the same mean energy as the irregular sea where $H_{m0} = \sqrt{2}H$ during T_e . T_e is fundamental in the calculation of wave power [see Table I.A.2]
Peak wave period	T_p	[s]	Spectral	Inverse of the most energetic frequency of the energy spectrum ($T_p = 1/f_p$)
	T_{pc}	[s]	Spectral	Statistical calculation of peak period from spectral moments
Mean direction	θ_m	[°or rad]	Spectral	Mean direction of propagation of wave energy calculated from the directional wave spectrum
Group velocity	c_g	[m/s]	Time domain	Wave group velocity, expressed as a function of water depth and wave number $k = 2\pi/L$.

$$c_g = \frac{1}{2}c_p \left(1 + \frac{2kd}{\sinh 2kd} \right)$$

where

$$c_p = \left(\frac{g}{k} \tanh kd \right)^{1/2}$$

where c_p is wave phase velocity, L is the wave length and d is the water depth

Wave power	P	[W/m]	Spectral
------------	-----	-------	----------

The power in a sea state transported per unit crest length in omnidirectional sea.

In deepwater,

$$P = \frac{\rho g^2}{64\pi} H_{m0}^2 T_e$$

For other water depths,

$$P = \rho g \int S(f) c_g(f) df$$

Directional spread	σ	[°or rad]	Spectral
--------------------	----------	-----------	----------

Represents the degree of directional energy concentration. Takes a peak value around T_p .

Spectral band-width	v	[-]	Spectral	A measure of the width of the spectrum, defined as the normalised radius of gyration of the spectrum about its mean frequency. For a Pierson-Moskowitz spectrum $v = 0.425$. For a JONSWAP spectrum with $\gamma = 3.3$, $\sigma_a = 0.7$, $\sigma_b = 0.9$, $v = 0.39$.
---------------------	-----	-----	-----------------	---

I.A.3 Wave Measurement

I.A.3.1 Measurement process

Need

A physical measurement programme shall be established during the development and operational stages of a wave energy project. The type of data to be obtained (summary statistics, spectra or time series) shall be determined by the stage of the project and the purpose for which it is required. The scale of the measurement programme shall be determined by the size of the wave energy development. An individual WEC deployment should require a single upstream measurement device. An array deployment may necessitate multiple measurement devices to quantify variations in the resource over the site. This shall be informed by numerical modelling and the complexity of the site.

Time series data should be recorded and archived for validation. Periodic summary reports including metadata shall be produced at appropriate intervals. For buoy measurements where data are transmitted to shore, reports should be produced on a monthly basis. However, when data recovery must be performed at sea because transmission is not possible, longer periods between reports are acceptable.

Data types

Summary statistics are essential to provide an overview of the device performance, and shall be calculated from a suitable wave spectrum. Wave height and period parameters are mandatory as the prime parameters for calculating mean power. For more detailed development and operational activities, summary statistics alone are insufficient.

Spectra provide fundamental methods for calculating the key parameters including wave power. They shall be calculated from time series data (§I.A.3.2) in either a directional or non-directional form. Spectra shall always be utilised when the purpose of measurement is engineering design and marine operations. Full directional spectra should also be used to better identify mixed sea states.

Time series data present time-ordered records of wave motion. Non-directional data is presented as a record of sea surface elevation, while directional datasets additionally include horizontal displacements/slopes/accelerations. Time series data are required for spectral analysis, but should not be used for direct calculation of parameters.

Methods of measurement

All physical wave measurements should be performed with either a wave measurement buoy or an acoustic Doppler profiler (ADP). Additional measurement methods including remote sensing and pressure transducers are not recommended because of their lack of validation for resource assessment purposes.

Wave buoys are designed for surface measurements in water depths greater than 10m. *ADPs* are usually seabed mounted and suitable for wave measurement in depths of 5 – 60m. They will also provide measurements of current. See EquiMar deliverable D2.2 for further description of wave measurement devices.

The following operational requirements shall be addressed:

- Calibration of the measurement device shall be performed both pre-deployment and post-recovery;
- For buoy measurement, the mooring system shall be demonstrated to provide minimal effect on the buoy motion;
- For ADP measurement, an anti-trawl seabed mount should be used to minimise risk of loss or damage due to fishing vessels;
- The minimum sampling frequency of the measurement device shall be 1 Hz, although a higher sampling frequency is preferable where operational issues permit;
- An ongoing maintenance programme shall be established for long-term deployments.

Quality Control

The adoption of adequate data qualification and quality control (QC) is mandatory. A suitable description of QC may be found in QARTOD (Quality Assurance of Real-Time Ocean Data ¹). The data provider shall demonstrate that their methods are robust in dealing with foreseeable quality control issues and that the data is fit for the intended use. For ADP measurements, the principal QC process is to confirm whether the acoustic quality of the measurements composing an ensemble average is satisfactory.

A description of the quality control methods shall be included with any data acquisition and analysis report. A description of the experience and expertise of the data providers may be included to provide confidence in the process. Additional reporting may include a description of any issues relating to the data that have been identified.

Metadata

In the reporting of wave measurement data, the following metadata shall be provided:

- Time stamp for each record in accordance with ISO 8601:
 YYYY-MM-DDThh:mm:ss<time>
 where <time> indicates the offset to UTC (Z in the case of no offset).
Examples:
 2010-10-05T10:00:00Z 10 a.m. 5 October 2010 – no UTC offset
 2011-04-15T13:30:00+02:00 1:30 p.m.15 April 2011 – UTC + 2 hours
- Location of the measurement device in latitude and longitude, measured in decimal degrees. The datum used must be stated.
- Mean water depth of the instrument deployment site.

¹<http://nautilus.baruch.sc.edu/twiki/bin/view>

I.A.3.2 Methods of analysis

Raw time series data (sea surface elevation for non-directional measurement, elevation and horizontal displacement/slope/acceleration triplets for directional measurements) should be transformed into frequency domain energy spectra for further analysis. The only exception is when the purpose of measurement is to investigate individual wave forms for the purpose of engineering design or device tuning.

Non-directional spectra $S(f)$ shall be produced through Fourier analysis of the sea surface elevation time series. The raw spectrum obtained through Fourier analysis shall be smoothed using a stated method. See EquiMar deliverable D2.2 for further details.

Directional spectra $E(f, \theta)$ should be calculated by multiplying a non-directional spectrum $S(f)$ by a directional distribution $D(f, \theta)$. The directional distribution of a sea state may be described at several levels of detail:

- *Directional distribution for each frequency*: Typically described by the four principal Fourier components for each discrete frequency.
- *Cos²s spreading function*: The spreading value s and the principle wave direction calculated with the first Fourier components are given for each discrete frequency. The spreading function is typically used as simplified description of the measured directional distribution or as an input to a numerical model (in the absence of a full directional distribution). If parametric spreading values are used the assumptions supporting this must be reported. If multimodal directional distributions are expected (energy at the same frequency in two different directions), MEM (Maximum Entropy Method, Lygre and Krogstad, 1986) must be used.
- *Summary parameters*: The high level directional properties may be assessed using the mean wave direction (averaged across all frequencies) and the mean power direction Θ_w . The principle wave direction for each frequency may also be recorded, although this information is difficult to present in an early stage, high-level, resource characterisation.

The application of these directional distributions and parameters are described in Figure I.A.7.

For both directional and non-directional spectral analysis, the following aspects must be considered:

- The maximum achievable spectral frequency is defined by the Nyquist frequency ($= 0.5f_s$ where f_s is the sampling frequency). For example, if measurement occurs at 1 Hz the shortest wave that can be detected has a 2 second period.
- Lower frequency cut-off should be in the range 0.025 – 0.05Hz and may be dependent on the proprietary measurement system and software used. This shall be explicitly stated in any report.
- Recommended upper frequency cut-off is 0.5Hz.
- Recommended frequency resolution is 0.01Hz or better.

Key parameters shall be calculated from non-directional spectra using spectral moments. The n th spectral moment is defined as

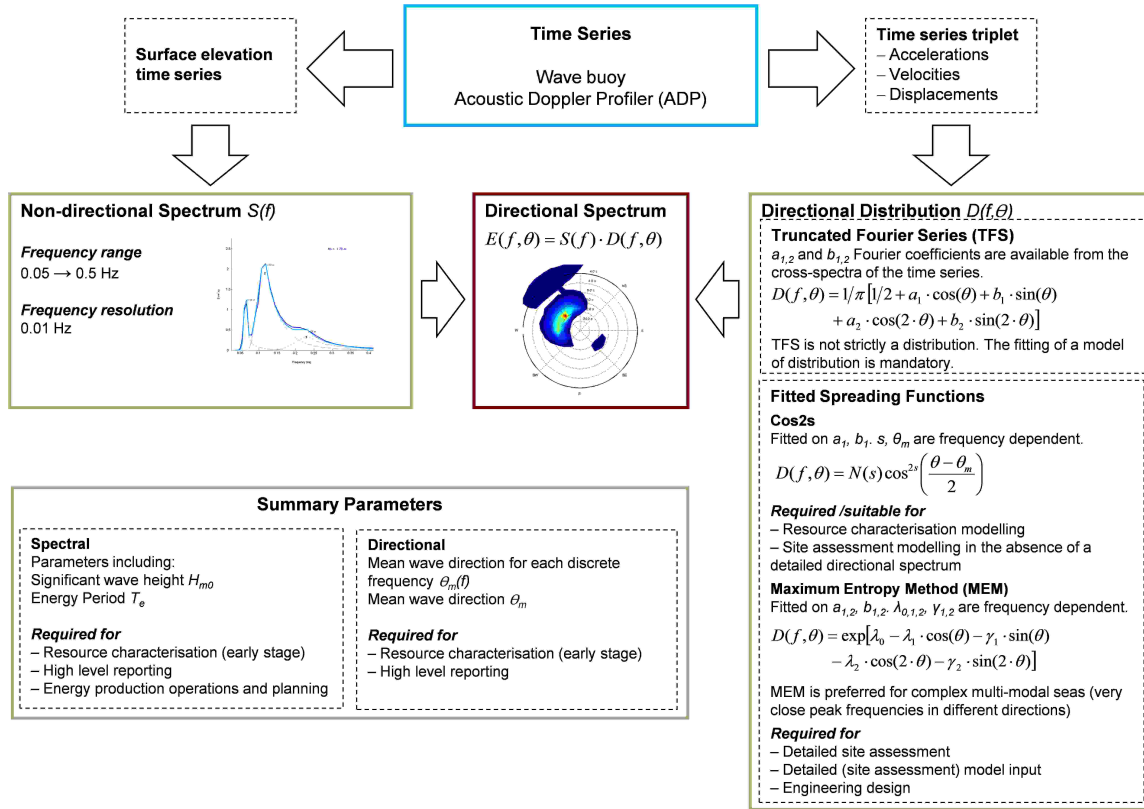

Figure I.A.7: Calculation of the directional spectrum from raw time series data.

Table I.A.2: Definition of key parameters in terms of spectral moments.

H_{m0}	T_{02}	T_e	T_{pc}	v
$4\sqrt{m_0}$	$\sqrt{\frac{m_0}{m_2}}$	$\frac{m_{-1}}{m_0}$	$\frac{m_{-2}m_1}{m_0^2}$	$\left(\frac{m_0m_2}{m_1^2} - 1 \right)^{\frac{1}{2}}$

$$m_n = \int_0^\infty f^n S(f) df \quad (I.A.1)$$

The moments $m_{-2}, m_{-1}, m_0, m_1, m_2$ shall be calculated and reported as a minimum requirement. Caution should be exercised when calculating higher order moments (e.g. m_3, m_4) because they might be unrealistically dominated by high frequency components of the energy spectrum and instrument noise. Table 2.3 defines the key parameters in terms of the spectral moments.

The wave power density level in a directional sea shall be calculated as

$$P_w = \int_0^{2\pi} \int_0^\infty c_g(f, d) E(f, \theta) df d\theta \quad (I.A.2)$$

where the group velocity $c_g(f, d)$ is defined as

$$c_g(f, d) = \frac{g}{4\pi f} \sinh \left(1 + \frac{2kd}{\sinh(2kd)} \right) \tanh \left(\frac{2\pi d}{\lambda} \right) \quad (I.A.3)$$

This is a transcendental equation and may be solved iteratively or using an approximate formulation (Fenton & McKee, 1990).

In deep water where $d > \frac{\lambda}{2}$, $c_g(f)$ approximates to $\frac{g}{4\pi f}$, allowing the mean power level to be calculated in terms of key parameters as

$$P = \frac{\rho g^2}{64\pi} H_{m0}^2 T_e \quad (\text{I.A.4})$$

This may be used for an initial estimate of power level, but for accurate quantification, Equation I.A.2 should be used.

Spectra should be visually inspected to qualitatively assess the occurrence of multi-modal sea states. If quantitative analysis is required, e.g. for detailed engineering design, a number of methods exist for calculating the component sea states of a spectrum, and are described in D2.2.

The mean power wave direction may be expressed as (Pontes et al., 2005)

$$\theta_w = \tan^{-1} \left(\frac{\int_0^{2\pi} \int_0^\infty c_g(f, d) E(f, \theta) \sin(\theta) df d\theta}{\int_0^{2\pi} \int_0^\infty c_g(f, d) E(f, \theta) \cos(\theta) df d\theta} \right) \quad (\text{I.A.5})$$

The uncertainty in the resource assessment comes from two main sources. Firstly, the measurement uncertainty from the field survey, and secondly the uncertainty arising from the modelling process.

Measurement uncertainty applies to all measurable quantities, such as site bathymetry, wave elevation, etc. A detailed budget of the measurement process should be assembled to determine this. The method of measurement should be rigorously analysed to account for all uncertainties involved in the instrumentation calibration, prior to instrumentation deployment.

Modelling uncertainty will depend on the modelling technique chosen and the available input data, and may be addressed by sensitivity studies as part of the calibration process.

I.A.4 Wave Modelling

I.A.4.1 Rationale

Wave modelling shall be used for resource assessment in the following situations:

1. Transfer of data from a remote site to the region of interest;
2. To obtain data over a wide geographical area;
3. To obtain long-term statistics not possible via a measurement programme.

Third-generation spectral models should be used to transform offshore data to nearshore regions of interest. For early stage assessments, global models, i.e. those intended for use over ocean-scale deepwater regions at low resolutions, may be used. For project development and operational modelling, dedicated nearshore models shall be used. See D2.3 for further discussion of such models. The use of numerical wave models for wave energy resource assessment is summarised in Figure I.A.8.

Careful consideration shall be given to the model inputs as discussed in the following sections. Studies have shown (see EquiMar deliverable D2.4) that given identical inputs and grid domain, most nearshore spectral models produce very similar results. Errors and inaccuracies in the model outputs will be primarily due to poor quality input data.

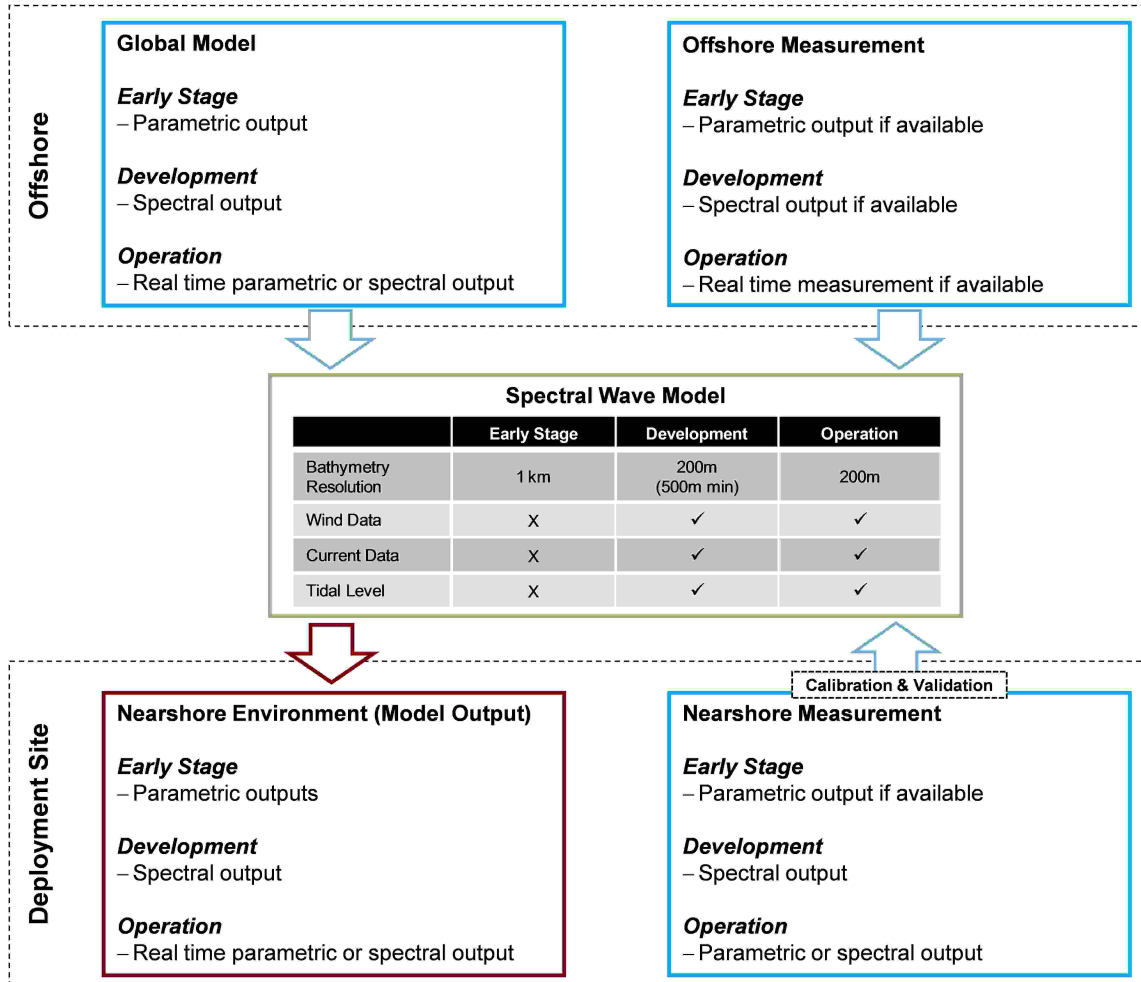

Figure I.A.8: Summary of the required inputs and expected outputs for numerical modelling for wave energy resource assessment.

I.A.4.2 Offshore boundary conditions

The type of data required for input at the offshore model boundaries shall be determined by the stage of the project.

Early stage resource assessment shall result in a minimum of ten years of data over a wide geographic area to allow selection of a particular site for development and provide an indication of inter-annual variation of the resource. The primary output shall be parameters (H_{m0} , T_e , θ_m), therefore parametric data will be sufficient for input at the offshore boundaries. These shall be obtained from one of three sources:

1. Archived global model output;
2. Results from running a global model using wind data as input (if local geometry does not affect the local accuracy, e.g. inner seas);

3. Long-term offshore measurements. This option is not recommended because of the lack of spatial coverage of most measurement programmes.

Modelling for project development and operation shall result in spectral output rather than simple parameters. To obtain meaningful results, inputs at the offshore boundary should be in the form of 2D spectral data. The minimum acceptable input is a separate description of wind waves and swell, each characterized by its own H_{m0} , T_p and θ_m . Input data shall be obtained from one of the following sources:

1. Archived spectral global model output;
2. Offshore measurement programmes.

It is anticipated that global models will usually be the most practical input to the model. Measured data may, however, occasionally be available as a model input. The accuracy gained from using measured data as an input should be balanced with the spatial variability provided by global model outputs when assessing which data source to use.

I.A.4.3 Bathymetry

The bathymetric resolution shall be high enough to ensure appropriate seabed features are resolved and shall thus be determined by the stage of the project. For early stage modelling, coarser resolution bathymetry (~1000-5000m grid spacing) will be acceptable. For more detailed modelling for project development and operation over smaller geographic areas (~50km), the minimum grid resolution shall be 500m. A resolution of 200m is recommended where data availability and computational capacity allow. Sources of bathymetric data are discussed in EquiMar deliverable D2.3.

Model nesting should be used when higher resolution bathymetry is not available for the whole model domain or for reasons of computational efficiency. An irregular grid with variable resolution may alternatively be used with some nearshore models rather than regular or curvilinear grids.

I.A.4.4 Metocean conditions

The inclusion of metocean data (wind, tides, currents) is unnecessary for long-term early stage modelling studies, but shall be considered if modelling is being applied for the later stages of a project development.

Wind shall always be included in detailed modelling studies. Where available, variable wind conditions should be applied across the model domain. Otherwise, a constant wind condition may be applied across the whole grid.

The inclusion of tidal data shall be determined by the tidal range at the site and the depth of the region of interest. In deep water areas, change of depth due to the tide will be unimportant and tidal data may be excluded. However, in intermediate and shallow water regions ($d < L/2$) where the tidal excursion may modify the depth by more than 5%, the effects may be significant and shall be accounted for in the modelling process.

Currents shall be included in the model if their velocity is greater than 2-3% of the local group velocity of the dominant waves. Where possible, the spatial distribution and time variance of currents in the area of interest should be determined. For long term simulation, tidal currents may be used in a parametric form.

I.A.4.5 Calibration and validation

Data from nearshore measurement devices located within the model domain shall be used to calibrate and validate the model performance for detailed site assessment studies. Parameters such as best-fit slope RMS errors, scatter index etc. should be calculated to quantify the model performance. See EquiMar deliverable D2.3 for details.

I.A.5 Interpretation and application of data to wave energy developments

I.A.5.1 Presentation of data

Data from a wave resource assessment shall be presented in a means appropriate to the stage of the project and the aim of the modelling. The following methods may be used:

- H_{m0} - T_e scatter plots
- Parameter time series
- 1D spectral plots
- 2D polar spectral plots

The appropriate method will be determined by the purpose of the assessment and the timescale over which data is required. Data requirements will usually fall into the following temporal categories:

1. *Long-term* assessments are performed to identify the level of resource and to investigate its inter-annual and seasonal variations. A minimum of ten years of data is recommended for such a study. The level of resource over this period should be summarised with scatter plots. Seasonal variations and inter-annual trends should be identified with plots of parameter time series for H_{m0} and T_e .
2. *Medium-term* assessments over a minimum of one year are required for more accurate predictions of power output, site-specific engineering design and the planning of operation and maintenance. Scatter diagrams should still be produced, but broken down into seasonal or monthly plots. Spectral data may be required in addition to basic parameters, and these should be presented in the form of 1D or polar 2D plots.
3. *Short-term* assessments are performed over a timescale of hours or days to assess short-term changes in the sea state for engineering design and operational issues. These should be presented as 1D or polar 2D spectral plots.
4. *Very short-term*: For operational prediction and device tuning, data in the form of elevation time series will be required to give individual wave states.

Scatter Diagrams

Scatter diagrams should plot H_{m0} against a measure of period T^* (T_p , T_{02} or T_e) in tabular form, although other combinations of parameters may be used. Each bin in the table shall represent the relative frequency of occurrence of that particular H_{m0} - T^* combination.

Scatter diagrams illustrating H_{m0} and T_e shall be produced to allow direct calculation of the mean wave power. If records of H_{m0} and T_e are not available due to the historic nature of the dataset this limitation should be noted and alternative scatter diagrams produced using significant wave height ($H_{1/3}$ or H_s) and mean period (T_{02} , T_z or T_{01}).

Scatter diagrams shall be produced to summarise the annual wave resource. Seasonal diagrams corresponding to *winter* (December, January, February), *spring* (March, April, May), *summer* (June, July, August) and *autumn* (September, October, November) may additionally be presented.

Scatter diagrams shall meet the following requirements:

- Each bin shall display the cumulative occurrences of the H_{m0} - T^* pair. Normalised scatter diagrams may additionally be presented, but the total number of data points used must be stated.
- H_{m0} bins shall be defined in 0.5m intervals over the range 0.5 to 15m.
- Wave period (T_e , T_{pc} , T_{02}) bins shall be defined in 0.5s intervals over the range 0.5s to 25s.
- Bin boundaries shall be defined by the relationship: *lower limit* < H_{m0} , $T_e \leq$ *upper limit*.
- The minimum and maximum bins shall have no lower and upper limit respectively, i.e. all H_{m0} observations exceeding 12m shall be contained within the largest bin. This shall be reflected in the axis labels.

Scatter diagrams displaying H_{m0} - T_e pairings may be translated into expected gross wave power levels. If the power output of a particular WEC is being considered it is necessary to refer to the power matrix. The power matrix gives the expected power output (in kW) for a particular combination of H_{m0} and period (typically T_e), calculated from a combination of tank testing, site testing and numerical modelling.

Parameter time series

Parameter time series provide plots of particular wave parameters over a fixed period of time. With a likely measurement interval of 3h, a full year's plot of significant wave height will appear very messy. Techniques such as applying a moving average to the data can smooth such plots and assist in identifying trends in the data.

Persistence tables

For operational planning, persistence tables shall be used to assess the availability of maintenance windows. These give the probability of occurrence that a particular wave height will be exceeded over a certain length of time (see Chapter II.B for further details).

I.A.5.2 Spatial variation

The spatial variation of the resource should be considered on both a wide geographical scale (~100km) and on a site specific scale (~5km). Variations on the geographic scale should be identified by numerical modelling as discussed in §I.A.4, and results used to identify locations for wave energy developments. On a site specific scale, the need for the information is as follows:

1. Power variation and averaging;
2. Optimum positioning of devices;
3. Power performance testing;
4. Establishment of limits of accuracy for data output for the site;
5. Comparison of ‘before and after’ effects from deployment of an array.

The quantification of variation in resource over site scales is the subject of ongoing research.

I.A.5.3 Extreme Value Analysis Requirements

Sea State Extremes

The mandatory requirement is to quantify the 10, 25 and 50 year return period H_{m0} at the project development stage. The 90% and 95% confidence intervals shall be reported. This analysis will usually be based upon the output of the modelling program due to the typically short duration of site measurements. Guidance on the analysis methodology is given in §I.A.4.

The assessment of extremes is not mandatory, but is recommended at the early stage of a project where a wide geographical area may be under consideration.

Individual Wave Extremes

The quantification of extreme individual waves is not mandatory but is recommended for 10, 25 and 50 year return periods. It is rarely feasible to examine statistics of individual waves directly as this information is not available from model hindcasts. Instead probabilistic techniques, as detailed in §I.A.4, should be employed.

I.A.6 Tidal Resource Characterisation and Site Assessment

I.A.6.1 Overview

§I.A.6 of the protocol will focus on resource assessment for tidal energy developments. Figures I.A.9 I.A.12 summarise the methods used for resource assessment at each stage of the process for a tidal energy development and the intended outputs.

Early stage assessment

Figure I.A.9: Resource assessment for the *early stage* aspect of a tidal energy development. TODO find appropriate pdf to include

Early stage resource characterisation is concerned with providing a first-order assessment of the available resource over a particular area (geographic scale). At the national or regional level, this may only require an assessment of pre-existing data such as tidal stream atlases or shelf tidal models. If used, a suitable model may be based on bathymetry soundings spaced about 1 or 2 km apart, and modelled at a resolution of not more than 5km. This

acts as a screening stage before selecting local areas for further development. Chosen local areas (e.g. strait, basin, headland) should be confirmed by a vessel ADP survey undertaken at spring tide. This is to understand the general pattern of the local flow. The local area must also be modelled in higher detail, using a shelf model as a boundary source. The local model should be based on bathymetry soundings of about 100m spacing, with a grid resolution of not more than 500m. Where local geography requires it, the model may need to resolve features of the order of 200m in scale.

Project feasibility assessment

Figure I.A.10: Resource assessment for the *project feasibility* stage of a tidal energy development. TODO find appropriate pdf to include

Feasibility assessment during the *project feasibility* stage is conducted to establish general characteristics at a specific site. This will involve a coordinated physical measurement and numerical modelling programme. The modelling programme is conducted to supply detailed spatial coverage at the site, and will require bathymetry derived from soundings with a spacing of about 20m or better. The model resolution should be of the order of 50m. Typically this model will include boundary data from a regional model. An *in situ* measurement programme will provide data to characterise the site and to calibrate/validate the model. The output of the site assessment process will include a detailed characterisation of the tidal stream as well as high level summary parameters. This stage will also provide a detailed economic model of the development.

Project development assessment

Figure I.A.11: Resource assessment for the *project development* stage of a tidal energy development. TODO find appropriate pdf to include

Site assessment during the *project development* stage is conducted to establish detailed characteristics at a specific site. At this stage the appropriate generating technology should be determined, and this stage should provide detailed information on individual tidal energy converter (TEC) locations. Allowance should be made for the physical dimensions of a TEC, and for sufficient top clearance (to provide for navigational safety and to avoid excessive wave loading) and bottom clearance (to minimise shear loading in the bottom boundary, and to avoid damage from submerged bed load materials). The full assessment will extend the modelling and measurement programme of the feasibility stage, to provide full information of the tidal components present at the site. The model bathymetry should be derived from soundings with a spacing of about 5m. The output of the site development process will include a detailed characterisation of the temporal variability of the tidal stream. Wave modelling may also be applied, to understand wave loading on the TEC and to inform device survival studies.

Operational assessment

Operational assessment during the *operational* stage will be dependent on the specific demands of the development. A minimum requirement is likely to be the simultaneous

Figure I.A.12: Resource assessment for the *operational assessment* stage of a tidal energy development. TODO find appropriate pdf to include

Tidal range	MHWS,MLWS,MHWN,MLWN,MHW,MLW. Tidal constituents
Tidal currents	Monthly and annual variation. Tidal constituents
Power density	Exceedence curves showing the expected power availability

Table I.A.3: Key tidal parameters

measurement of resource and TEC performance for benchmarking. Short term forecasting may assist device tuning and maintenance scheduling. Modelling is expected to be a continuation of the development assessment model in the previous stage, and may require periodic re-calibration as the body of site measurements grows.

I.A.6.2 Key tidal parameters

The primary output of a tidal resource assessment shall be parameters that describe the level of resource throughout the life of a project. The key parameters that should be obtained and reported through the resource assessment are described in Table ???. All tidal current parameters should be calculated through tidal harmonic analysis. Other parameters are a necessary part of the evaluation, particularly for model validation although they need not form part of the reporting process.

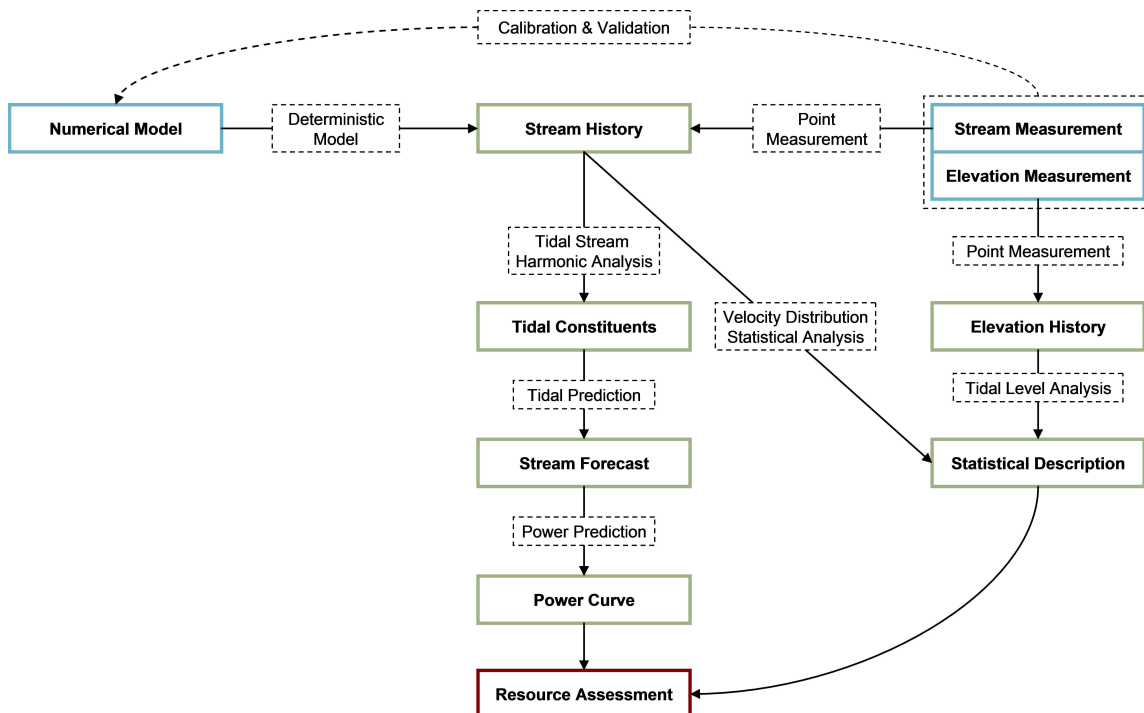

Figure I.A.13: Methods for obtaining key parameters from resource assessment.

Table I.A.4: Common tidal constituents, in usual order of importance.

Common name	Description	Period (hrs)	Rank
M2	Principal lunar semidiurnal	12.42	1
S2	Principal solar semidiurnal	12.00	2
N2	Larger lunar elliptic semidiurnal	12.66	3
K1	Lunisolar diurnal constituent	23.93	4
M4	Lunar quarter-diurnal shallow water overtide	6.21	5
O1	Lunar diurnal	25.82	6
M6	Lunar sixth-diurnal shallow water overtide	4.14	7
MK3	Terdiurnal shallow water compound tide (M2 + K1)	8.18	8
S4	Solar fourth-diurnal shallow water overtide	6.00	9
MN4	Quarter-diurnal shallow water compound tide (M2 + N2)	6.27	10

Site characteristics

The following site characteristics shall be recorded at the start of the project development stage of a tidal energy project:

1. *Bathymetry* at the site shall be established through a bathymetric survey.
2. *Tidal range* at the site shall be established by measurement.
3. *Tidal constituents* at the site shall be established by combined modelling and site survey. Maximum tidal currents shall be extrapolated from the harmonic information. Examples of the typically more important constituents are shown in Table I.A.4.
4. *Wind* at the site shall be established using ongoing measurement. Meteorological model output and/or offshore wind measurement stations may be needed for operational forecasting.

Calculated parameters

The following parameters shall be considered for a resource assessment:

1. *Tidal stream power* at the locations, established through survey and measurement;
2. *Power exceedence curves* showing generating availability at the locations;
3. *Direction* of axes of tidal ellipses at the locations;
4. *Vertical velocity profile* of the tidal stream at the locations.

I.A.7 Tidal Measurement

I.A.7.1 Measurement process

Need

A physical measurement programme shall be established during the development and operational stages of a tidal energy project. The principal measurement instrument is the ADP, and the number of deployed sensors shall be determined by the stage of the project. An

individual TEC deployment should usually require a single measurement device located near to, and on the minor axis of the tidal ellipse centered at the TEC. An array deployment may necessitate multiple measurement devices to quantify variations in the resource over the site. This shall be informed by numerical modelling and the complexity of the site.

Time series data should be recorded and archived for validation. Periodic summary reports including metadata shall be produced at appropriate intervals. For measurements where data are transmitted to shore, reports should be produced on a monthly basis. However, when data recovery must be performed at sea because transmission is not possible, reports should be produced for each instrument deployment.

I.A.7.2 Data types

Summary statistics are essential to provide an overview of the device performance. Peak ebb and flood in each spring and neap should be recorded. Wave height and period parameters are likely to be useful for device endurance purposes.

Tidal components provide the principal method for calculating long-term statistics.

Time series data present time-ordered records of tidal stream data. The velocity data and the acoustic quality data should be archived. The velocity data will be used to establish tidal parameters and turbulence parameters. The acoustic quality data is used in the QC process.

I.A.7.3 Methods of measurement

All principal tidal stream measurements should be performed with an acoustic Doppler profiler (ADP). Wave measurements may be needed for operational use, and ADPs may also be used for this purpose. Wave buoys are not suitable for use in a high tidal stream. Remote sensing may also be used to measure surface velocities, to assist model calibration, but are not able to measure sub-surface velocities.

ADPs are usually seabed mounted and suitable for current measurement in all applicable water depths. They are capable of surface (i.e. downward looking) mounting, which may be of use in certain applications. In this mode the stability and movement of the mounting platform must also be considered. The maximum vertical distance (bin spacing) between samples shall be 1 metre. Sufficient bins shall be recorded to provide complete coverage of the TEC cross-sectional capture area in the tidal stream. An ADP with a pressure sensor should be deployed to measure tidal elevation at the site. See EquiMar deliverable D2.2 for further description of tidal measurement devices.

The following operational requirements shall be addressed:

- Calibration of the measurement device shall be performed both pre-deployment and post-recovery.
- For ADP measurement, an anti-trawl seabed mount should be used to minimise risk of loss or damage due to fishing vessels.
- The minimum sampling frequency of the measurement device shall be 2Hz.
- An ongoing maintenance programme shall be established for long-term deployments.

Quality control

The adoption of adequate data qualification and quality control is mandatory. A suitable description of QC may be found in QARTOD. The data provider shall demonstrate that their methods are robust in dealing with foreseeable quality control issues and that the data is fit for the intended use. The principal QC process is to confirm whether the acoustic quality of the ADP measurements composing an ensemble average is satisfactory.

A description of the quality control methods shall be included with any data acquisition and analysis report. A description of the experience and expertise of the data providers may be included to provide confidence in the process. Additional reporting may include a description of any issues relating to the data that have been identified.

Metadata

In the reporting of tidal measurement data, the following metadata shall be provided:

- Time stamp for each record in accordance with ISO 8601: YYYY-MM-DDThh:mm:ss<time> where <time> indicates the offset to UTC (Z in the case of no offset). *Examples:*
2010-10-05T10:00:00Z 10 a.m. 5 October 2010 no UTC offset
2011-04-15T13:30:00+02:00 1:30 p.m.15 April 2011 UTC + 2 hours
- Location of the measurement device in latitude and longitude, measured in decimal degrees. The datum used must be stated.
- Mean water depth of the instrument deployment site.

I.A.7.4 Methods of analysis

After applying the QC process, tidal stream data should be averaged into 10 minute samples. For each sample, the vertical binning should be applied across the capture surface of the TEC to determine the available stream power during the sample. Consider the power capture surface area of the device to consist of a series of horizontal strips. Each strip shall be denoted by subscript k . Each strip has the height of the vertical bin separation, $z_k = Z$, and each strip shall have width b_k , and there are a total of S such horizontal strips. The stream speed through each slice k in a sample shall be denoted U_k . The notional capture area of the device is $\hat{A} = \sum_{k=S}^{k=1} b_k \cdot z_k$. The ‘performance velocity’, U_{perf} of the sample shall be computed by

$$U_{perf} = \left[\frac{1}{\hat{A}} \sum_{k=S}^{k=1} U_k^3 \cdot b_k \cdot z_k \right]^{1/3}$$

Lastly, the total available stream power ($= P_{KE}$) in the sample may be calculated by

$$P_{KE} = \frac{1}{2} \rho \hat{A} U_{perf}^3$$

I.A.7.5 3.3.3 Quantification of uncertainty

The uncertainty in the resource assessment comes from two main sources. Firstly, the measurement uncertainty from the field survey, and secondly the uncertainty arising from the modelling process.

Measurement uncertainty applies to all measurable quantities, including site bathymetry, tidal stream velocity, local water density, etc. A detailed budget of the measurement process, including the instrumentation calibration process, should be assembled to determine this. The ADP measurements will depend on local water temperature, for example.

Modelling uncertainty will depend on the modelling technique chosen, and may be addressed by sensitivity studies as part of the calibration process.

I.A.8 Tidal Modelling

I.A.8.1 Rationale

Hydrodynamic modelling shall be used for resource assessment in the following situations:

1. To provide data on water levels and currents over a wide geographical area. Indeed, measurements may provide good information on water levels and currents but, when available, the information is usually based upon a limited number of point measurements and for a limited duration. Modelling provides an effective means of completing this information in time and space given knowledge of the local bathymetry.
2. To predict the resource and its temporal variations;
3. To evaluate the impact of power systems on the resource;
4. To investigate the potential impact of climate change on energy production.

Hydrodynamic models can represent tidal flows as well as wind-driven and wave-driven flows. The models are generally based on shallow water equations (2D models) solved using finite difference or finite element methods. These models are able to provide data on water levels and barotropic currents over a wide geographical shallow water area, and to optimise device positioning.

Careful consideration shall be given to the model inputs and calibration. Model results will only ever be as good as the equations the model is based on and the quality of the input data used. Given identical bathymetry resolution and offshore boundary conditions, the state of the art tidal models produce generally very similar results (see D2.5). Higher quality results are obtained with good quality input data (bathymetry and offshore tidal constituents) and with a well-calibrated drag coefficient.

I.A.8.2 Offshore Boundary Conditions

On the open boundaries, the sea surface elevation must be specified. It shall be obtained from different sources:

1. *Harmonic composition using tidal constituents*: Heights of tidal constituents are provided in various databases (FES2004, Schwiderski datasets). Careful consideration shall be given to the number of components considered in harmonic composition.
2. *Parent models*: This applies in the case of model nesting.

If information is available, e.g. from a parent model, boundary currents may also be prescribed.

The influence of open boundary conditions is particularly significant if boundaries are close to the area of interest and located in a shallow water area. If reliable boundary

conditions are not available, it is therefore necessary to build a sufficiently large approach model to propagate the tidal data from offshore to the coastal area. This may be achieved by using nested models or with a finite element triangular grid.

I.A.8.3 Bathymetry

Currents and water levels are influenced by deep ocean tides, the shape of the coastline and the near-shore bathymetry. In shallow water, a coarse bathymetry leads to a coarse representation of current. For early stage modelling, bathymetry may be extracted from global databases such as GEBCO or ETOPO (see Deliverable D2.3 for further discussion on sources of bathymetry data). These databases provide bathymetry with a resolution up to 0.5° , which is an acceptable grid resolution at this stage. Data coherence must be checked through comparison between the different databases and, if available, visual comparison with charts.

For more detailed modelling of the project and to optimise positioning of the devices, a computational grid resolution of 10 - 50 m is recommended. However, this must be coherent with input data available. To achieve 10m resolution, model nesting should be used with finite difference methods, for reasons of computational efficiency. Finite elements offer more flexibility with a variable spatial resolution of their triangular elements. They avoid nesting; however, the construction of the computational grid is more complex and they require specific tools for pre and post-processing of the modelling.

I.A.8.4 Metocean conditions

The inclusion of metocean data (wind and wave) is unnecessary for early stage modelling studies, but wind effects shall be considered in detailed modelling studies for the later stage of a project development.

If available, variable (in time and space) wind conditions should be applied on the computational domain. Otherwise, wind effects should be studied with schematic wind scenarios. The aim is to inform engineering design with respect to expected exposure to damaging currents under extreme wind conditions combined with high tidal range.

For operational assessment, forecast atmospheric conditions shall always be provided as input into the hydrodynamic modelling.

Wave-driven flows become significant in the very near shore area; typically in the surf zone. So, their action domain is out of the region of interest for tidal energy devices.

I.A.8.5 Calibration and validation

Current and water level measurements must be used to calibrate and to validate hydrodynamic modelling. If available, meteorological information (wind and pressure) shall be used since atmospheric conditions may affect the strength of currents and the evolution of the water level.

Initial model calibration may be performed using long-term records of tidal elevation from tide gauge networks. Current data from atlases and navigation charts may also be used. As a second step, when in-situ current and water level measurements are available, the quality of the modelling may be assessed.

Validation of modelling may be achieved in different ways:

1. Comparison with rose diagram for typical current conditions (usually mean neap tide and mean spring tide).

2. To compute statistical errors between model and measurement (RMSE, Scatter Index, phase difference, tidal amplitude difference)
3. Performance of tidal harmonic analysis of both model results and measurements and comparison each tidal constituent (amplitude and phase) separately. This method avoids the consideration of meteorological effects. However, it requires a long measurement and simulation period of a minimum 1 year.

Two dimensional models based on shallow water equations are generally sufficient for tidal resource assessment. For such barotropic models, the main physical parameter to adjust during the calibration phase is the bottom friction coefficient. Drag coefficient acts on tidal propagation and have an influence on both amplitude and phase. Other processes can interfere with tidal propagation and modify current and sea levels, e.g. wind stress may affect current velocity like atmospheric pressure affects the sea level. These effects must be evaluated for project development and for operations.

I.A.9 Interpretation and application of data to tidal energy developments

I.A.9.1 Presentation of data

At a specified location, tidal data may be presented in different forms:

1. Rose diagrams for typical current conditions during mean neap tide and mean spring tide.
2. Time series for current velocity and water level.
3. Tidal spectrum, i.e. computation of the tidal constituents.

During the development phase of the project, rose diagrams and tidal spectra are produced. For operational assessment time series for current velocity and water level are required.

I.A.9.2 Spatial variation

The spatial variation of the resource shall be considered on both a wide geographical scale and on a site specific scale. Variations on the geographical scale may be identified by coarse numerical modelling. On a site specific scale, the need for the information is as follows:

1. Power variation and averaging (the tidal resource is the most accurately predictable ocean resource)
2. Optimum positioning of devices
3. Power performance testing
4. Impact of the devices on the resource, leading to interaction between the devices (local impact)
5. Impact of the devices on the environment (regional impact)

I.A.9.3 Extremes

Extreme sea levels and currents may be specified in several different ways. For clarity, the discussions will distinguish extreme high sea levels from extreme currents.

Extreme sea levels

These levels, including the tide, surge and mean sea level, may be called *still water levels* to distinguish them from the total levels, which include waves. Waves may be accounted for separately in risk analyses, although more elaborate procedures may allow for some correlation between storm surge and high-wave conditions.

High water extreme events typically result from a high water on a spring tide and a storm surge. So, a good way of estimating probabilities of extreme levels is to make use of separate distribution of tidal and surge frequencies (joint tide-surge probability approach). Otherwise (i.e. annual maxima approach), if the largest meteorological surge of a dataset coincides with a low tidal level, this information is ignored despite its obvious relevance to the problem of estimating extreme level probabilities.

The JPM (joint probability method) uses the fact that the statistics of tide and surges are largely independent and compiles separate tables of the distributions of both quantities. The principle advantages of the joint tide-surge probability approach are:

1. Stable values are obtained from relatively short periods of data. A single year can yield useful results, but four years is desirable to sample several storms.
2. There is no waste of information.
3. The probabilities are not based on large extrapolations.
4. Estimates of low water level probabilities are also produced.

Joint tide-surge probability estimates of extremes require datasets of good quality, with timing accuracy to better than a few minutes, and a high degree of analytical skill.

Extreme currents

Extreme currents are more difficult to estimate than extreme levels. The first difficulty is to obtain a sufficiently long series of data; few in situ data extending over more than a year exist because of the expense and the technical difficulties of making good measurements. Further complications arise because currents are variable with depth at each location, and because they change over short distances, particularly near the shore and around shallow sandbanks. In those cases, the most powerful approach is to use the results of numerical models.

As for levels, extreme currents may be estimated by separation of the observed current vectors into tidal and surge components. Two dimensional frequency distributions are obtained for each component, but in the simplest case of the currents being rectilinear or if only speeds are considered; the problem may be treated in exactly the same way as for estimating extreme levels. Where the flow is not rectilinear, the flow in two orthogonal directions may be treated separately. North-south and east-west components are usually chosen, but the directions of the major and minor axes of the current ellipses are also suitable. The maximum components in each of the four directions may be then estimated from probability plots produced by combining the probability distributions of the separate tidal

and surge components. The joint probability technique for estimating extreme currents has the same advantages and disadvantages when applied to levels.

For more detail on extreme statistics and methods of calculation see deliverable D2.6.

I.A.10 Site Considerations

I.A.10.1 Constraints on Exploitation

A resource assessment shall also consider physical and technical constraints on exploitation of the marine energy resource at a particular site due to device-specific requirements. These shall include:

- Required water depth for deployment and operation
- Seabed composition for device installation and cable-laying
- Extreme wave predictions

Additional constraints on exploitation will occur due to existing structures and exclusion zones, and co-existing marine activities such as fishing grounds, shipping lanes and military practice areas. These factors shall all be considered during the project scoping and environmental assessment. See Protocol IB, Environmental Assessment, for further details.

I.A.10.2 Device Survivability and Assessment of Extremes

The calculation of extreme wave or sea state statistics (e.g. 50-year return period H_{m0} value) is challenging due to the typically short duration of physical measurements and the possible bias in long duration hindcasts. The return period will usually be longer than the duration of the dataset (whether from measurements or modelling). There is a low probability that an event close to the return period value will be observed during the observation period. It is, therefore, necessary to apply extrapolation techniques using empirical distributions to quantify these long return period values. As with all techniques of extrapolation the result is very sensitive to the chosen extrapolation model. This model must be chosen based upon robust physical or statistical considerations.

In order to estimate the value (of e.g. H_{m0}) associated with a particular return period the distribution of the annual maxima must be estimated from the time series (typically sampled at 20 minutes, 1 hour or 3 hours).

The parameter examined by the analysis is usually the annual maximum. The first phase is to estimate the distribution of this annual maximum from time series classically sampled to 20min, 1h or 3h. The return value x_N is then simply obtained by:

$$P(X_{max.year} \leq x_N) = 1 - \frac{1}{N} \quad (\text{I.A.6})$$

where P is the distribution of the annual maximum and N is the number of years. For example, $N = 100$ for the hundred-year H_{m0} return value $H_{m0,100}$.

Two general techniques, the block maxima and storm maxima methods, are available for the calculation of the distribution of the annual maximum. These techniques are described in more detail below.

Block maxima methods

If the database is sufficiently long (e.g. 40 years for the ERA40 ECMWF hindcast), the empirical distribution of the annual maximum can be obtained directly from the sample of the 40 annual maxima. Generally, it is better to consider a smaller block size (e.g. a month), that remains sufficiently large to maintain independence between values. In that case the distribution of the annual maximum is obtained from the monthly maximum by

$$P(X_{max.year} \leq x) = P(X_{max.month} \leq x)^n \quad (\text{I.A.7})$$

with $n = 12$, the number of months in a year

The last step is to fit an analytical distribution to the empirical for extrapolation to high levels and to calculate x_N . The application of a GEV distribution is recommended as described in deliverable D2.6.

Storm maxima methods may be used as an alternative to the block maxima approach but greater user expertise is necessary. For details see deliverable D2.6.

Seasonality

Seasonality should be taken into account as it can significantly affect the results of the extrapolation (see D2.6). The effects of climate change may also be introduced given that robust models of such an evolution exist to describe sea-state or wind storm severity.

I.A.10.3 Sample Size

The return value confidence interval reduces with increasing dataset duration. Longer return periods require a longer duration dataset. **The minimum dataset requirement is a duration 20% of the return period (e.g. 10 years data for a 50 year return period).** The confidence intervals of the return period value shall be reported.

I.A.10.4 n-year individual wave height

Time series of individual wave heights (or sea state H_{max}) values are rarely available over long periods and are not available from hindcasts. Methods can be used, based upon the knowledge of the conditional distribution (to H_{m0} and T_m) of H_{max} , to quantify the n-year H_{max} value.

This conditional distribution can be used, either directly on the sea-state with n-year H_{m0} return value or in the calculation of the wave height maximum distribution by applying the law of total probability

$$P(H_{max} \leq h) = \int P(H_{max} \leq | H_{m0}, T_m) \cdot f_{H_{m0}, T_m}(h_{m0}, t_m) \cdot dh_{m0} \cdot dt_m \quad (\text{I.A.8})$$

with the H_{m0} maxima distribution.

The joint distribution of significant wave height and period is generally given in the form

$$f_{H_s, T_m}(h_{m0}, t_m) = f_{H_{m0}}(h_{m0}) \cdot f_{T_m | H_{m0}}(t_m | h_{m0}) \quad (\text{I.A.9})$$

The methods described here to waves can be applied to wind or current speed, and other short term parameters such as crest height

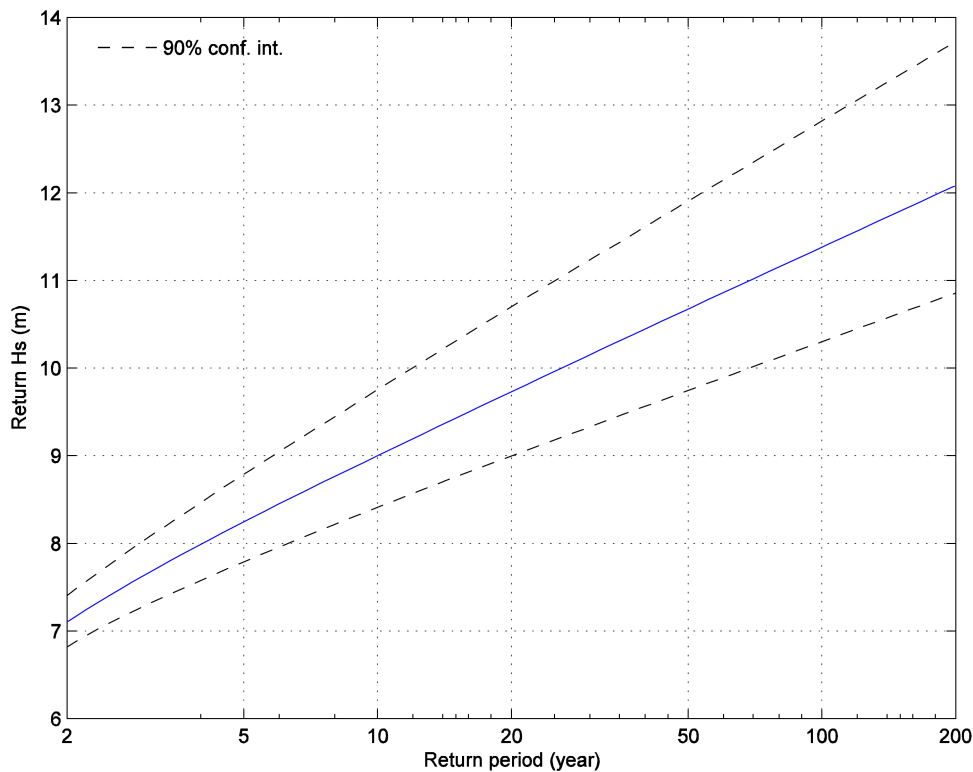

Figure I.A.14: Typical representation of return values.

Multivariate extreme extrapolation

The examination of multivariate extreme statistics is more complex. The simplest approach is to associate different return values to define the n-year conditions, e.g. 100-year H_{m0} associated with 20-year wind speed associated with 10-year current speed. The choice of the set of return periods is based on experience and is dependent on the design criteria. A new approach (I-FORM environmental contours) provides a pure metocean answer to this issue. It is based upon First Order Reliability Methods (FORM).

For more details on extreme sea state statistics and these methods of extrapolation, see D2.6.

I.A.11 Reporting

Level of the Resource

The resource shall be quantified over the periods outlined in §I.A.2 and §I.A.6 depending on the project stage. This quantification will be conducted using the key parameters as defined in this protocol (§I.A.2.2 / I.A.6.2). Guidance on the presentation of this information is given in §I.A.5.1 and §I.A.9.1 .

Limits of the Assessment

The level of detail required from the resource assessment is dependent on the project stage, as broadly defined in §I.A.1 and in more detail in §I.A.2.1 and §I.A.6.1. The purpose of the resource assessment should be clearly stated (e.g. early stage resource assessment to establish first order resource characteristics). Any deviations from the outputs listed in this protocol should be stated.

Site Particulars

The particulars of a site shall be presented including

- A chart detailing the geographic area covered by the resource assessment. This chart shall include a clearly legible scale and geographic coordinates in decimal degrees.
- An overview of the site bathymetry. If a modelling programme has been conducted the bathymetry used in the programme should be presented.
- Any constraints (§I.A.10.1) on exploitation should be reported. If these constraints relate to a particular geographic area this should be noted on the site chart.

Measurement Programme Instrumentation

The particulars of the measurement devices and data collection procedures shall be recorded. This includes

- Instrument type, manufacturer and model.
- Confirmation that device has been calibrated in accordance with the manufacturer's specification and that this calibration is valid over the duration of the deployment.
- Deployment information including location and water depth in accordance with the metadata requirements detailed in §I.A.3.1 / I.A.7.1
- For a wave buoy details of the mooring system (e.g. schematic) should be given.
- The sampling frequency and bin sizes (for an ADP) should be given along with any instrument specific settings that may be relevant to the interpretation of the data.
- Quality control procedures applied to the data prior to analysis should be noted and explained.

Analysis Methodology

The analysis methodologies and techniques applied to the raw data should be detailed. This should include

- Details of the software utilised. This may include proprietary and non-commercial software (e.g. custom MATLAB scripts).
- The underlying theory should be explained or referenced. For example, if a directional spectrum is presented the analysis methodology (e.g. MEM) should be stated.
- The methodology used for the analysis of extreme conditions (where applicable).

Numerical Modelling Programme

If a numerical model programme has been conducted the following information should be reported

- Details of the model and software version.
- The model domain, mesh details and resolution
- Details of the model input (e.g. global model) including inputs such as wind
- The source and resolution of bathymetry data
- Any other model specific information

Model and Measurement Data

- The metadata describing the data source (i.e. modelling or measurement programme) should be referenced in accordance with the requirements given above.
- The time stamp for each sample shall be recorded in accordance with §I.A.3.1 / I.A.7.1.
- All recorded parameters should be clearly defined using recognised terminology (see §I.A.2.2 / I.A.6.2)
- Electronic data shall be stored using a non-proprietary format (e.g. ASCII, NetCDF).

References

- [1] J. Fenton and W. McKee, “On calculating the lengths of water waves,” *Coastal Engineering*, vol. 14, no. 6, pp. 499 – 513, 1990.
- [2] A. Lygre and H. E. Krogstad, “Maximum entropy estimation of the directional distribution in ocean wave spectra,” *J. Phys. Oceanogr.*, vol. 16, 1986.
- [3] M. T. Pontes, R. Aguiar, and H. O. Pires, “A nearshore wave energy atlas for portugal,” *Journal of Offshore Mechanics and Arctic Engineering*, vol. 127, no. 3, pp. 249–255, 2005.
- [4] QARTOD, “Quality assurance of real-time oceanographic data.”

Chapter I.B

Environmental Assessment

TODO - Introduction Omitted pending editorial intervention!

I.B.1 Environmental assessment approaches

The environmental assessment of wave and tidal projects is a process that should be carried out by project developers to inform stakeholders and regulatory bodies in their assessment and decision making process from concept to decommissioning.

EIA and SEA are the legal tools used for conducting impact assessment at different levels. EIA is the traditional approach that has been widely used to address environmental impacts of a given project. SEA is a more recent mechanism for identifying and assessing the likely significant environmental effects of a plan or programme and its alternatives. SEA and EIA are tools that share a common root - impact assessment, but have different assessment foci: strategies for future development with a high level of uncertainty in SEA; proposals and measures, concrete and objective, for the execution of projects in EIA.

The results of other techniques application such as ERA (Section 2.2) and LCA (Section 2.3 and Equimar Deliverable 6.4.2) can also be applied or consulted during the EIA and/or to inform and support the decision making process of the device concept design and activities planned. The results of these complementary instruments can further be integrated in the EIA report.

I.B.1.1 Strategic Environmental Assessment

SEA is a recent strategic tool that ensures the incorporation of environmental considerations into policies, plans and programmes at a regional or national scale. It is therefore used by strategic authorities to consider the potential wide-ranging effects of plans and programmes in a structured way and to demonstrate that environmental and other effects have been taken into account during their preparation. In Europe, the SEA Directive (2001/42/EC) entered into force in 2004 and thus few examples of its application are available. In UK, the Scottish government conducted a SEA for marine renewables. This document was concluded in March 2007 [1] and covers the entire west and north coast of Scotland to a distance of 12 nautical miles offshore based on where the main wave and tidal resource areas are located. In the UK a series of SEA reports covering offshore energy (offshore wind, offshore oil and gas and gas storage) have been published with a specific SEA report targeting renewable wind published in 2009 available online [2]. Outside of the European Community, examples of the SEA process application to offshore energy

sector are available for Canada, where the Offshore Energy Environmental Research Association (OEER) was commissioned by the Nova Scotia Department of Energy to carry out a SEA focusing on tidal energy development in the Bay of Fundy [3]. SEA recommendations need to be taken into account in all environmental assessment planning for specific projects on marine renewable energy and should provide very relevant information for use in site selection.

I.B.1.2 Environmental Risk Assessment

Risk assessment or analysis is a well established management tool for dealing with uncertainty. It usually helps decision makers or other interested parties in a variety of purposes: determine environmental and health problems associated with several activities and substances (for example, hazardous waste disposal and the use of chemicals); compare new and existing technologies or determine the effectiveness of different control and mitigation techniques designed to reduce risks; select sites for potentially hazardous facilities; set management priorities, such as which of several activities should be considered first for regulatory or corrective action [4]. Risk Assessment has been only recently extended to wider environmental considerations. Environmental Risk Assessment (ERA) is a generic term for a series of tools and techniques concerned with the structured gathering of available information about environmental risks and then the formation of a judgment about them [5]. EIA and ERA are very similar concepts in that they have broadly the same goals that are to inform decision-makers on the frequency and magnitude of adverse environmental consequences. However a major additional aspect provided by ERA is that it provides the probability of a particular impact occurring. A general framework for an ERA is presented in Figure I.B.1.

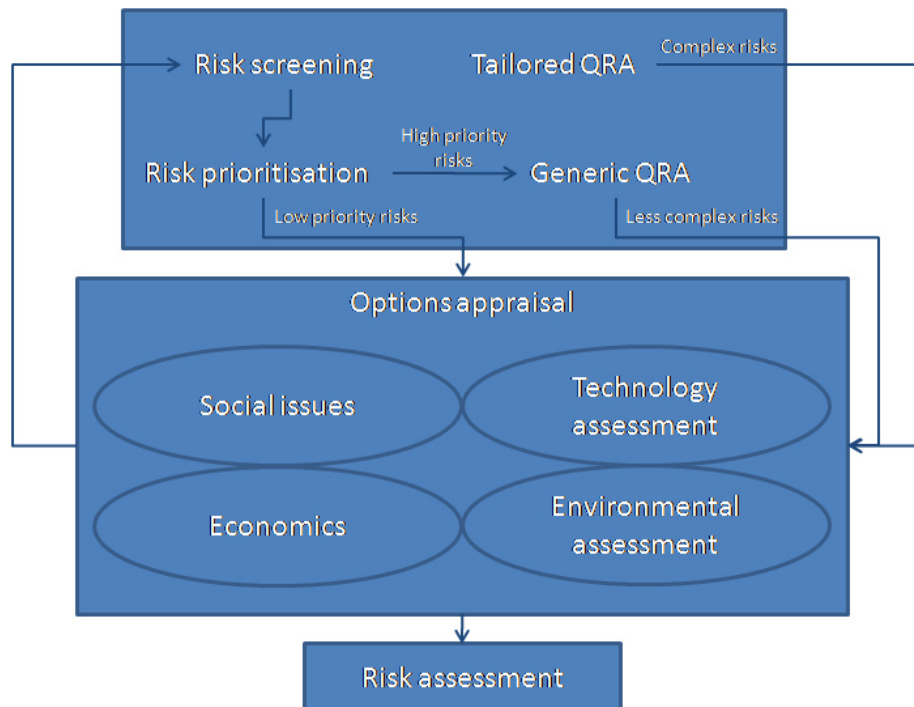

Figure I.B.1: A framework for environmental risk assessment; QRA: Quantitative Risk Assessment (adapted from [5]).

A risk assessment framework has been proposed for large renewable deployments [6].

It is considered especially useful to evaluate such deployments along coastal national areas when political decisions based on scientific evidence, comparison to other energy supply options, stakeholder and public concerns all have to be taken into account. This framework concerns potential risk evaluation of marine renewable energy deployments based on a consistent program of research over time that collects relevant data by each sectoral group (marine mammals and fish, safety within ship lanes, etc). The proposed approach recognizes that every site has a unique set of potential risks and thus information is needed across risks and sites in order to discover where the problem areas or the benefits may be. This integrated framework also addresses what the potential tradeoffs may be in deciding whether to site a renewable technology or some other energy supply option. Although it has only been applied to the renewable energy sector in a draft version, this technique has been already modified specifically for it including offshore wind and marine (wave and tidal) energy technologies.

Figure I.B.2 presents the framework step application designed for land based and offshore wind but can be used to evaluate siting of all marine renewable energy options, including wind and wave technologies. The steps of the Environmental Risk Assessment framework are described in [6].

Figure I.B.2: A framework for integrated risk analysis of renewable energy deployments (from [6]).
TODO find appropriate pdf to include

I.B.1.3 Life Cycle Assessment

LCA represents a tool to estimate the cumulative environmental impacts resulting from the whole product life cycle, often including impacts ignored in traditional analyses (e.g. raw material extraction, transportation, maintenance process, final disposal, etc). An LCA allows a decision maker to study an entire product system, avoiding the sub-optimization that could result when the focus of the study is on only a single process. The LCA helps to avoid shifting environmental problems from one place to another. Burden shifting can occur from one life-cycle phase to another, from one location to another or from one environmental problem to a different one. By including the impacts throughout the whole product life cycle, LCA enables a comprehensive view of the environmental aspects of the product or process and a more accurate picture of the true environmental trade-offs in product and process selection. It is important to note that LCA is always performed relative to a 'functional unit'.

The LCA process is regulated by the International Standards Organization (ISO) 14000 series:

- ISO 14040: 2006 (Environmental management - Life cycle assessment - Principles and framework) [7]
- ISO 14044: 2006 (Environmental management - Life cycle assessment - Requirements and guidelines) [8]

According to the definition given by the ISO standards, LCA is “a technique to assess the environmental aspects and potential impacts associated with a product, process, or service, by:

- Compiling an inventory of relevant energy and material inputs and environmental releases

- Evaluating the potential environmental impacts associated with identified inputs and releases
- Interpreting the results to help decision-makers to make a more informed decision” [7]

LCA is a procedure constituted by four different phases (Figure I.B.3) [7]:

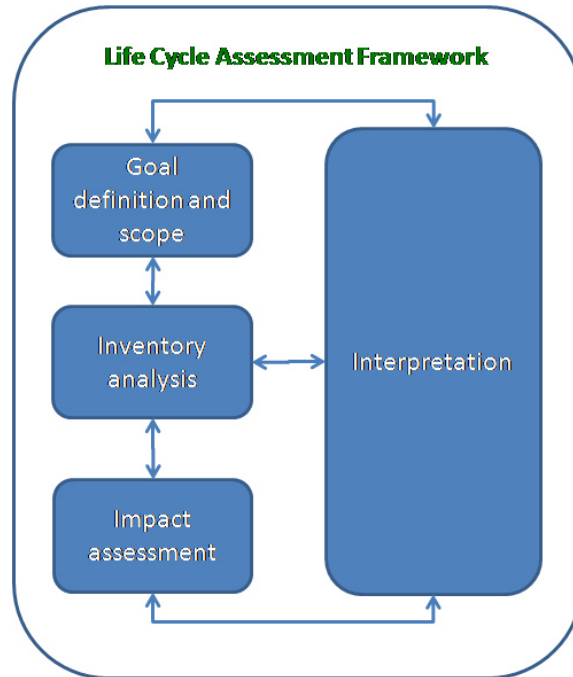

Figure I.B.3: Phases of a LCA (adapted from [7]).

1. **Goal Definition and Scoping** - Define the purpose of the study. It includes a description of the studied product, process or activity. Establish the context in which the assessment may be made, identify the functional unit to be used and establish the system boundaries and limitations. This phase includes a description of the method used for assessing potential environmental impacts and which impact categories will be included in the study.
2. **Inventory Analysis** - Consists of data collection and analysis. For each process within the studied system boundaries, data including energy, water and materials usage and environmental releases (air emissions, water emissions, solid waste disposal, etc.) are quantified. Other types of exchanges or interventions such as radiation or land use can also be included. Data are then processed to produce an inventory of inputs and outputs per functional unit.
3. **Impact Assessment** - Assess the potential environmental effects of the inventory items identified in the inventory analysis. Contribution to impact categories such as global warming and acidification are evaluated by calculating impact potentials from the LCI results. Economic and social impacts are typically outside the scope of LCA.
4. **Interpretation** Evaluate the results of the LCA study to draft conclusions and make decision, taking into account not only the numerical results, but also the boundaries

of the system, the quality of data and the sensitivity of results. The interpretation phase can be used to adjust the goal definition or improve the inventory analysis or the impact assessment investigation, showing as the LCA is an iterative process in which all the phases are interdependent, as illustrated in Figure I.B.3. Interpretation may include normalization to provide a basis for comparing different types of environmental impact categories. Although non-compliant with the ISO standards, an impact weighting process is sometimes undertaken to create a single impact measure based on the users' subjective judgment of the relative importance of particular factors.

Examples of LCA for different renewable energy technologies can be found in [9], [10] and [11]. LCAs for marine energy devices have also been published for the Seagen tidal current turbine [12], the Pelamis [13] and Wave Dragon [14] wave energy converters. A review and guidelines on LCA for marine energy technologies are presented in Equimar Deliverable 6.4.2.

I.B.2 Adaptive management

The initial lack of information regarding new technologies constrains the accurate assessment of environmental impacts. There is a need to learn from the device's operating experience in order to validate the predicted environmental effects of a project and adapt mitigation and/or monitoring strategies as knowledge progresses. This process of adaptive management centres on an iterative process used by resource managers to improve management decisions over time while environmental impacts are still uncertain. Adaptive management is not a new concept and the steps for its application to wave and tidal energy projects have been proposed elsewhere and could be used as guidance for developers, regulators or managers (e.g. [15], [16], [17]). It is recommended that it should be employed at the project developers' level rather than mandated by a particular authority since its proper implementation requires ownership and regulatory management. For initial projects, the implementation of adaptive management plans may require a close liaison between developer and regulator.

I.B.3 Site selection and conceptual design: environmental concerns

The environmental assessment of a project should start at site selection and project development design. The identification of environmental risks for a given site (and/or alternatives) and/or device type and the incorporation of environmental criteria in the decision making process of the development design are considered environmental best practices. These practices aim to minimise negative impacts, maximise positive impacts and reduce development constrains at the early stage of the environmental assessment process. The Scottish guidance for Marine Renewable Energy Developments [18] presents several useful criteria that should be taken into account for site selection and design stages of the project development. Based on this approach examples of criteria that should be taken into account are presented in Table I.B.1.

Table I.B.1: Examples of criteria that should be considered when selecting a potential development site for a given development design (adapted from [18]).

Criteria for site selection	Examples
Marine Spatial planning	Strategic Environmental Assessment
The proximity of the site to nature conservation interests	Special Areas of Conservation; fish spawn areas at certain times of the year
Cumulative or in combination impacts with other nearby developments	Noise disturbance and proximity of cetacean habitats
Regulatory context	Proximity of legal protected areas
Potential impacts on landscape and visual amenity	Beach proximity
Availability of access and necessary infrastructure	Transport routes, number and type of vessels, frequency of transport
Effects on other marine uses	Navigation, tourism and fisheries
Impacts on wildlife	Proximity of migratory routes or movement routes of birds and cetaceans
Criteria for project development plan	Examples
Device design	Marine animal physical harm due to sharp edges of the machine
Device installation and decommissioning operations	Disturbance on fisheries in the vicinity
Methods of operation	Collision of marine animals with the device rotor blades
Device maintenance activities	Antifouling methods and vessel traffic

I.B.4 Environmental Impact Assessment guidelines

The current methodology model of EIAs is a stepwise approach, which requires continuous reappraisal and adjustment as is shown by the feedback loops in Figure 21. The EIA process steps are briefly described below taking into account its application to wave and tidal energy projects.

I.B.4.1 Screening

Screening is the process to identify whether or not an EIA is required for a given project or development and what needs to be done if an EIA is not required. The legal framework which supports the screening process is the EIA Directive (85/337/EEC as amended by 97/11/EC) regarding the decision on whether the project typology falls within Annex I or Annex II. Annex I provides a list of projects for which EIA is mandatory and a statutory EIS is required. The projects listed under Annex II may require an EIA either through a case-by-case analysis or by considering thresholds or criteria set by each Member State. Wave and tidal energy projects are likely to fall within Annex II category and the criteria for the EIA requirement differ within European countries (a legislation review is presented in Equimar deliverable 6.1.1).

The screening process usually requires that the developer contact the regulator entity for comments on the project characteristics. The way this communication with the regulatory bodies starts also varies within countries but key information on the project such as device design and operation, equipment to be installed, size of the project, site(s) under

consideration, timescale and duration of the project, identification of significant constraints and any other specific queries is usually requested by the authorities.

At the end of the screening process the developer should be clearly informed on what environmental studies or information he will need to provide to the regulator to support the consent application. If an EIA and a statutory EIS are required, the developer progresses to the EIA Scoping step.

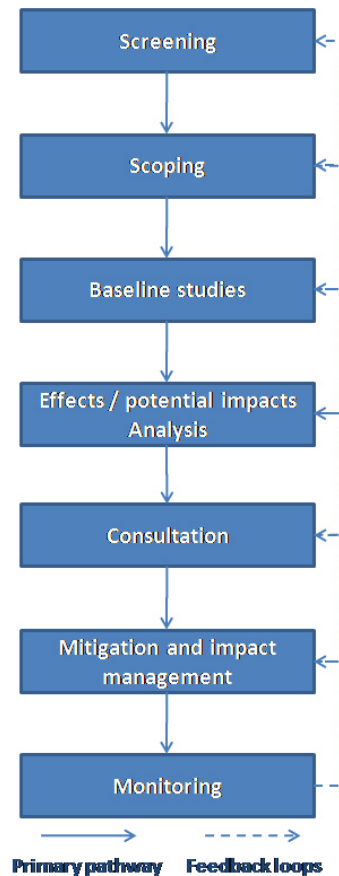

Figure I.B.4: Esquemathic representation of the Environmental Impact Assessment methodology (adapted from [19]).

I.B.4.2 Scoping

The Scoping process is an essential step of the EIA, which aims to identify, at an early stage of the project development, the key environmental issues that will need the most attention. Environmental key issues are e.g. environmental receptors significantly affected by the project, effects or potential impacts of the project on the environment, environmental issues that need detailed study (both desk study and or baseline survey), methodologies to use, possible mitigation measures, constraints that may pose problems and whom to consult. During this process, a number of potential environmental and socio-economic impacts can be avoided through amendments to the e.g. choice of location, technology and materials. Scoping checklists and matrices are valuable tools to fulfil this exercise, particularly in identifying key impacts and receptors. The selection of appropriate consultants and interest groups can also be addressed using a checklist ([20], [21]). Examples of the application of such tools are given in section 3 below. The scoping exercise should provide

a ground plan for subsequent EIA steps determining what information should be submitted to the regulator within an EIS and what actions need to be taken to compile the required information and its detail (methods and levels of study needed to obtain reliable baseline information). The findings of the scoping exercise are usually reported in a scoping report. A lack of detailed information at the scoping stage means that scoping estimates and decisions should be reassessed in the light of baseline information gained as the EIA progresses [20].

The initial task of the scoping exercise is a comprehensive description of the device(s) and associated activities. This shall focus on the aspects that are important from an environmental perspective and a non-expert language should be used to simplify its understanding.

An example of the project description details to be considered is presented in the EMECs EIA guidance for developers [22]. The scoping report should also provide information on the project location (for all offshore and onshore aspects of the project) and the suggested alternatives to the development. Table I.B.2 presents a (non exhaustive) summary of the key information that can be submitted in the scoping report.

The scoping report is usually submitted by the developer to the regulator, who collates the information from statutory consultees which in turn should define the scope of the EIS to be submitted. Therefore, it is a good practice to update the scoping report in light of the information received.

It is usually during the scoping stage that the requirement for an Appropriate Assessment (AA) is determined. According to the Habitats Directive an AA is required if a project is likely to have a significant effect on a Natura site i.e. a Special Protected Area (SPA) or a Special Area of Conservation (SAC). An EIA cannot substitute the need for an AA and it is the responsibility of the competent authority (with advice from conservation agencies) to determine (and fully justify) whether a proposed project is likely to have a significant effect on a European site. Guidelines on AA application and development regarding offshore projects can be found elsewhere (e.g. [18], [19], [23], [24] and [25]).

I.B.4.3 Baseline studies

Baseline studies are the backbone of the components (or descriptors) assessments. They inform about the reference condition on environmental and socio-economic systems in the impact area and are the basis for valid impact predictions and effective mitigation and monitoring programmes. Sometimes the required information can be compiled by means of a desk study, which is generally less expensive and time-consuming than obtaining new data. Furthermore, it is pointless to undertake new work that duplicates existing information. Strategic Environmental Assessments (SEAs) made for offshore marine renewable energy and Marine Spatial Plans can be very useful at this stage of the process since they provide various offshore biological, ecological and geological data. The assessment of the environmental datasets for a given location should be one of the first tasks (undertaken from the screening procedure) in order to ascertain what data is available and to determine what, if any, further information is required. It is essential that detailed consideration be given to the selection of the components (or factors) to be described, ensuring the inclusion of all pertinent aspects and eliminating any irrelevant factors. The factors that have to be addressed are site-specific, and to some extent device-specific, which means that there are no exhaustive guidelines on aspects that should be considered. However there will be some similarities in the baseline data required of renewable energy projects, they are likely to include bathymetry, benthic ecology, birds and marine

Table I.B.2: Example list (non-exhaustive) of key information to be submitted in a formal scoping report (adapted from [20] and [18]).

Topics	Contents
Project details	<ul style="list-style-type: none"> • Device characteristics • Location and suggested alternatives for the development • Summary of the project activities (e.g. installation, maintenance and decommissioning methods and plans)
Potential effects	<ul style="list-style-type: none"> • List of receptors likely to be affected by project stages and activities • Identification of the potential environmental impacts • Knowledge and data gaps
Mitigation measures	<ul style="list-style-type: none"> • Possible mitigation measures • Guidance on identifying the preferred option from an environmental perspective
Methods and level of studies	<ul style="list-style-type: none"> • Details / plan for conducting technical studies, methodologies and resources to be used • Methodologies for baseline surveys (field work)
Consultation	<ul style="list-style-type: none"> • Stakeholder consultation strategies • List of consultants and interest groups
Structure of the EIS	<ul style="list-style-type: none"> • Suggestion on the contents and length of the EIS

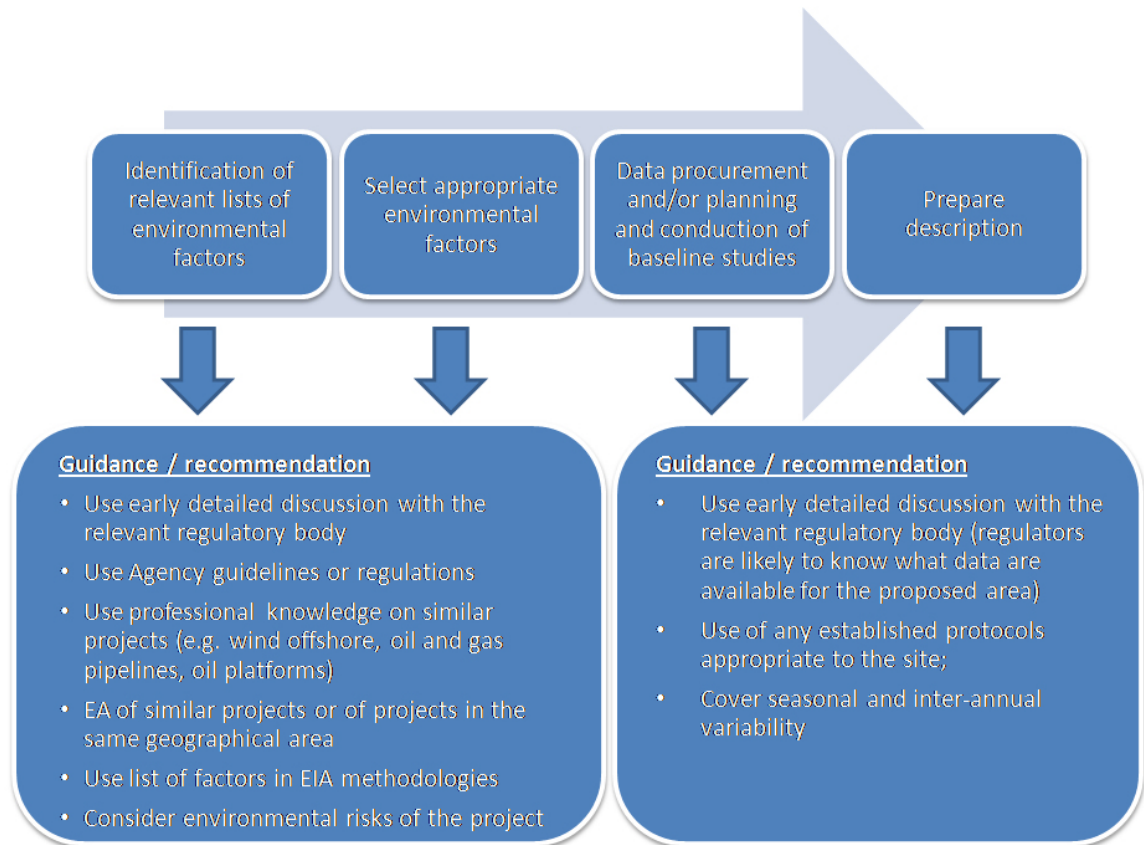

Figure I.B.5: Conceptual framework for baseline description and guidance/recommendation regarding wave and tidal energy projects.

mammals ([18], [26]). The types of issues that might need to be considered are listed in Table I.B.3. It is important that good baseline characterisation data is collected for all anticipated environmental effects of the project (Section I.B.4.2). Particular attention should be paid to environmental characteristics that correspond to the risks identified for the device designs under consideration (Section I.B.4.4).

Figure I.B.5 presents several approaches that may be used to identify the list of environmental components with potential relevance to the project environmental assessment.

Another important aspect to be considered in the collection of relevant baseline data is the coverage of the environmental variability timescale, since the conditions may change seasonally or inter-annually. The survey duration for baseline data collection depends, amongst others, on the sensitivity of a site and on the species under study (species associated with the seabed, marine mammals, birds, fish, etc). Criteria for sensitivity evaluation are presented below (Section I.B.4.3). Amendments to generic protocols required to deal with site specific issues should be based on expert advice, taking full account of the analytical framework within which the data collection is nested. If an AA is required (Section I.B.4.2) the baseline survey should also include the collection of data needed to support its development.

Sensitivity characterization

In the baseline characterization, an evaluation should be carried out on the sensitivity of the site (or site alternatives) regarding both environmental and socio economic issues. The

Table I.B.3: Type of issues that might be considered under the baseline line survey (adapted from [18]).

Key topics for wave and tidal project EIAs
Designated sites
Coastal sedimentary processes
Geology, hydrology and hydrogeology
Benthic ecology
Fish and shellfish
Commercial fisheries
Marine mammals
Birds
Terrestrial habitats and ecology
Marine uses: navigation, fisheries, cultural heritage, recreation and access
Visual landscape and seascape
Noise and vibration
Cumulative and in-combination impacts

site selected for wave or tidal energy projects strongly influences both the potential environmental and socio-economic impacts; each site will have its unique sets of sensitivities. When available, the Strategic Environmental Assessment of wave and tidal energy development provides important information, at the strategic level, on the potential environmental effects of this type of projects in a given area. This information should be taken into account when evaluating the sensitivity of a given site. The criteria to identify environmentally valuable areas for protection are well-established (a recent review can be found in [27]). The environmental sensitivity of a site is generally associated with the identification of species, habitats and/or areas of marine natural heritage importance. Accurate characterisation of special natural features is an essential initial stage in site selection. Table I.B.4 presents a set of criteria for biological valuation of a site. The assessment approaches for each criterion are described elsewhere [27].

The identification of the spatial and temporal distribution of habitats and species (using both field work or existing data) could be made for each site as well as for its adjacent area taking into account the Red List Species¹ can be used as well as the lists of habitats and species provided in the annexes of the Habitats and Birds Directives. From the socio-economic perspective, sensitive locations are those where conflicts may arise from the number and type of other uses of the same space or resource. Sensitive locations from a socio-economic perspective are those with a high variety of interests (uses). Where in place, Strategic Environmental Assessment and / or Marine Spatial Planning can assist in identifying the nature, location and extent of these other uses to aid in the process of selecting a suitable site and in conflict management.

I.B.4.4 Impact analysis

Screening and scoping inform the developers of the environmental impacts that the project is likely to have in the environment. The next stage is to deepen this analysis through the assessment of the potential impacts scale both onshore and offshore². Therefore, an under-

¹Red List Species: available at <http://www.iucnredlist.org/>

²In this work only offshore environmental assessment is considered

Table I.B.4: Example of a set of marine valuation criteria and their definitions [27]. These criteria were selected from three different sources of literature: articles on peer-review articles, reports on selection criteria for Marine Protected Areas (MPAs) and international legislative documents that include selection criteria (e.g. EC Birds and Habitats Directives, RAMSAR convention, OSPAR guidelines, UNEP Convention on Biological Conservation).

Valuation criteria	Definition
Uniqueness / Rarity	Degree to which an area is characterised by unique, rare or distinct features for which no alternatives exist
Aggregation	Degree to which an area is a site where most individuals of a species are aggregated for some part of the year or a site which most individuals use for some important function in their life history or a site where some structural property or ecological process occurs within an exceptionally high density
Fitness consequences	Degree to which an area is a site where the activity(ies) undertaken make a vital contribution to the fitness (increased survival or reproduction) of the population or species present.
Resilience	The degree to which an ecosystem or a part/component of it is able to recover from disturbance without major persistent change
Naturalness	The degree to which an area is pristine (i.e. absence of perturbation by human activities) and characterized by native species (absence of introduced or cultured species)
Proportional importance	Global importance: proportion of the global extent of a feature (habitat/seascape) or proportion of the global population of a species occurring in a certain subarea within the study area. Regional importance: proportion of the regional (e.g. NE Atlantic region) extent of a feature (habitat/seascape) or proportion of the regional population of a species occurring in a certain subarea within the study area. National importance: proportion of the national extent of a feature (habitat/seascape) or proportion of the national population of a species occurring in a certain subarea within territorial waters.

standing of the project and of the baseline environmental conditions (Section I.B.4.3) at the proposed site, are required. The impact analysis is composed of three main levels of detail: identification (which, as referred, already started in the scoping step), valuation and significance. To aid the first two levels of the assessment there are several standard techniques / tools that are listed and briefly described in Table I.B.5. Section I.B.5 below presents a review of the application of such tools to the environmental impact assessment of wave and tidal energy projects. The criteria used in valuation of the impacts may be qualitative and/or quantitative. Qualitative assessments usually employ ratings such as neutral, slight, moderate or large (applied to both negative and positive impacts), whereas quantitative assessments involve the measurement or calculation of numerical values (Table I.B.6). The final task in the impact analysis stage consists on the analysis of the significance of the impacts which is the product of the recognized impact characteristics (e.g. magnitude and extent in space and time) and the sensitivity value and recoverability of the relevant receptor(s). It therefore requires an evaluation of these receptor attributes, which should have been carried out in the baseline evaluation [20]. A stepwise approach for the evaluation of impact significance of wave and tidal developments is proposed in the Scottish Marine Renewables Licensing Manual [18] and a criteria grid to evaluate the significance of marine energy impacts is established in the EMECs guidance for developers [22].

The impact analysis is often the most difficult step an EIA. Direct impacts are usually easy to identify but indirect and cumulative impacts are, sometimes, much more difficult. It is also important to note that impact analysis is not an exact science having bound by a degree of uncertainty which should be clearly stated in the EIS [20].

The likely significance of impacts can be used to prioritise them. However, impact prioritization is only possible when device(s) monitoring data is available for the analysis of impacts significance. Therefore, at the current knowledge stage it is essential to determine what environmental monitoring should be prioritised. EMEC carried out a workshop with regulators, their advisors and academia to reach agreement on the relative prioritisation of the development of monitoring methods for environmental issues where information was insufficient for impacts evaluation and consequent best practice methodologies (Table I.B.7). According to this consultation, collision of marine species with the devices and alteration to species behaviour were considered the high priority issues for monitoring regarding marine wildlife, navigation and limitation of fishers access to actual or potential fishing ground were the priority issues concerning socio-economic impact monitoring.

I.B.4.5 Consultation

During the researching of the EIA, culturally appropriate levels of public consultation shall be undertaken. Mechanisms are needed to ensure that all interested parties or stakeholders are participating in the EIA process and contributing to it with concerns and / or opinions which can further be integrated in the decision making process. The Marine Renewables Licensing Manual developed for the Scottish Government [18] refers that “one of the aims of the streamlining of the consenting / licensing process for marine renewables projects is to ensure that consultation at all levels is with the right party and progressed at the right time”. Thus, it is recommended that besides the formal public consultation required under the EIA regulations the developers begin informal consultations at an early stage of the project consenting process involving regulatory bodies, their advisors and other stakeholders including local interest groups and the public in general.

There is still a need to develop the technical aspects of public consultation on marine energy projects in order to make it more effective. It is good practice to develop a consulta-

Table I.B.5: Commonly used methods for impact identification and prediction (adapted from [20] and [21]).

Method	Features	Examples
Checklists	Useful for identifying key impacts especially in scoping. Can include information such as data requirements, study options, questions to be answered and statutory thresholds but not generally suitable for detailed analysis	Lists of specific areas of potential impacts and or environmental attributes
Matrices	Mainly used for impact identification; provides the ability to show cause-effect links between impact sources (plotted along one axis) and impacts (plotted along other axis). They can also indicate features of impacts such as their predicted magnitudes.	Leopold matrix Petersons matrix [28] Rapid Impact Assessment Matrix [29]
Mathematical / statistical models	Based on mathematical or statistical functions, which are applied to calculate deterministic or probabilistic quantitative values from numerical input data. They range from simple forms that can be employed using a calculator or computer spreadsheet, to sophisticated computer models that incorporate many variables. They need adequate / reliable data. The results usually require validation.	Mathematical models on water quality, noise and behaviour of biological systems
Maps and GIS	Maps can indicate features such as impact areas, as well as locations and extents of receptor sites. Overlay maps can combine and integrate two or three layers, e.g. for different impacts and/or environmental components or receptors. GIS can analyse a number of layers, and has facilities for the input and manipulation of quantitative data, including modelling.	Priority Habitats map (Natura 2000) Maps on the distribution of commercial of bivalve banks

Table I.B.6: Example of classification criteria used in impact valuation.

Criteria	Qualitative grade	Quantitative grade
Nature of impact	Direct, indirect	-
Signal	Positive, neutral, negative	-
Magnitude (severity)	Maximal, moderate, minimal	Threshold levels (e.g. level of a pollutant; noise levels)
Probability of occurrence	High, medium, low	-
Duration	Temporal, permanent	Duration time of each occurrence
Frequency / Periodicity	Continuous, Discontinuous, periodic (e.g. seasonal), regular occurrence, rare	
Temporal extension	Immediate, short term, medium term, long term	Duration time (e.g. during installation or operation)
Spatial extension	Local, adjacent, regional, national, global	Degrees and extension of impact areas of influence
Recoverability	Irrecoverable, irreversible, reversible, recoverable, fugal	-
Inter-relations between actions and effects	Simple, cumulative, synergetic	-
Need for mitigation measures	Critical, severe, moderate Total, partial, no-mitigation	-
Importance	High significance, significant, low significance, irrelevant	-

tion strategy document listing the stakeholders to be involved in the process as well as the actions and techniques to be used. The experience from offshore wind projects is valuable and its principles and techniques can be adapted to the wave and tidal energy projects. Reviews on the social, economic and cultural concerns of offshore wind energy are available in the literature (e.g. [30]). The British Wind Energy Association produced a useful report on best practice guidelines on consultation for offshore wind energy developments which addresses the principles, stages and techniques for good consultation [31]. Other useful examples of frameworks are available in the literature (e.g. [32]) as well as case studies of consultation on wave and tidal energy projects (e.g. [33], [34]).

I.B.4.6 Mitigation and impact management

Mitigation measures are formulated to avoid, minimise / reduce, remedy or compensate for the predicted adverse impacts of the project. An additional best practice should also investigate to include the enhancement or the improvement of the site beyond the existing baseline [18]. Some of these measures can include: selection of alternative locations; modification of the methods and timing of construction, modification of design features, minimisation of operational impacts (e.g. noise and collision), etc.

Different mitigation measures are needed according to the specific impacts on the environmental components and receptors. Where appropriate, impacts should be minimized at the design phase (see Section 4). The Environmental Impact Statement (EIS) should indicate detailed measures on how to carry them out and propose how they can be modified if unexpected post-project impacts arise. The selection of mitigation measures should give priority to avoidance of impacts, then minimization and finally restoration. Where impacts of medium and high significance are identified, mitigation should be proposed to reduce frequency, probability or extent of the impact. Residual impacts are those that remain following impact mitigation [20]. Discussion on mitigation measures for wave and tidal energy developments is available in several reports (§I.B.5; Table I.B.12).

I.B.4.7 Monitoring

After the baseline characterization, an operational monitoring plan should accompany the project installation, operation and decommissioning process taking into account that each site is unique and may benefit from more or less monitoring as regards its baseline characterization. Monitoring is the key to validate and expand the findings of the initial EIA. Its conclusions must flow into future assessments at all levels, from the baseline study to the impact evaluation and mitigation measures. The monitoring needed to understand and minimize environmental impacts has either a site-specific (conducted by the developer) and a general (addressed by collaborative groups) value; collaborative monitoring studies can help the individual developers to refine their designs and operations in order to minimize the environmental impacts. Regarding wave and tidal energy developments the monitoring plan should:

- Quantify the presence and extent of key impacts of the device deployment and supporting activities on the identified environmental sensitive issues;
- Be performed throughout device installation, operation decommissioning and post-decommissioning periods during prototype sea-trials and commercial operation scales in line with recommendations from regulators and current state of knowledge regarding specific potential impacts;

Table I.B.7: Environmental interactions / potential impacts of wave and tidal energy developments and its relative prioritization. The priority column represents the relative prioritisation for the development of new monitoring methods where there are no well established best practices. This does mean that an issue which is considered important for the industry, but for which there are well established monitoring methods available, the priority ranking will be low since no new methods need to be developed [29].

Receptor of interaction	Nature of interaction	Priority
Wildlife, particularly marine mammals and birds, but including a few other species such as basking sharks	Collision with devices, particularly tidal turbines	H
	Alteration to wildlife behaviour. For example, reduction in access to feeding areas (mammals and birds), avoidance arising from “barrier effects” of arrays of devices in restricted waters	H
	Entanglement of wildlife in moorings	L
	Damage to hearing (mammals and fish) primarily from survey (e.g. seismic) activities, and construction work (pile driving)	L
	Underwater noise - construction	L
	Underwater noise - operation	M
Seabed, habitats and species	Physical disturbance of the seabed	M
	Alteration to sediment movements	L
	Alterations to benthic faunal communities through changes in flow or wave exposure.	M
	Vibration	M
Marine productivity	Alteration of primary production in development areas	L
Navigation	Surface vessels, merchant shipping, fishing vessels, naval vessels	H
	Submarine navigation	H
Commercial fisheries	Limitation of access of fishers to actual or potential fishing grounds	H
	Impacts on fish spawning grounds	L
	Direct impacts of devices on fish	L
Aesthetic impact	Visual impact of objects on the sea surface	M
	Impact on marine (underwater) landscape	M
This section covers a very wide range of forms of interaction with the marine environment. Almost all are not unique to wave and tidal energy developments and are well managed in other contexts.	Leaching of antifoulants from devices	L
	Chemical and oil spill risks	L
	Redistribution of contaminants, primarily contaminated sediment	L
	Changes in turbidity	L
	Debris loss	L
	Impacts on marine archaeology	L
	Recreational users	L/M

- Follow an adaptive management process in order to identify and respond to uncertainties regarding the projects effects;
- Provide a rationale for the type, number and duration (e.g. seasonal, inter-annual) of measurements according to the key environmental aspects identified in the baseline survey; where possible, reference protocols or methods/ instrumentation should be used;
- Assess the cumulative interference of multiple devices on the receiving environment to establish appropriate array spacing and assist the design of the final deployment arrangement; in this case monitoring should follow a stepwise approach to allow the evaluation of the environmental effects of scaling up the number of units
- Assess the cumulative interference of the project in combination with other effects / impacts;
- Provide a context for the use of numerical and statistical models in the quantification.

The progress on the understanding of wave and tidal energy environmental impacts would be faster if monitoring results could be made available for stakeholders and other developers. This practice would streamline the licensing / consenting process and contribute to accelerate projects implementation. Table I.B.8 presents examples of monitoring methodologies currently in use for the marine environment components. More information can be found in review reports of environmental key issues of marine energy projects presented below (§I.B.6; Table I.B.12). The Equimar Deliverable 6.5.2 (Analysis of Case Studies and Useful Tools) presents several case studies and tools on environmental monitoring for wave and tidal energy devices.

I.B.5 Impact analysis tools

In this section a number of tools for the environmental impact assessment are listed and briefly described. Wherever possible, examples of the use of such tools in the environmental assessment of wave and tidal energy projects are given.

I.B.5.1 Checklists

Checklists are widely used tools to address project description and EIA scoping. Checklists also provide a systematized means of identifying impacts. They can be developed for application to particular types of projects and categories of impacts sectoral checklists such as ocean energy projects. However, checklists are not as effective in identifying higher order impacts or the inter-relationships between impacts, and therefore, when using them, consider whether impacts other than those listed may be important (NET).

As an example, according to EMECs guidance to developers [22], a detailed description list of project characteristics should be provided including developers management system/structure, testing schedule, device structure and operation, mooring or foundation system, installation and power requirements, materials that are going to be used, hydraulic systems, corrosion protection, antifouling system, power conversion system, noise and vibration levels, device marking, electrical systems, heating / cooling and communication systems, shore connections and facilities, energy storage and sink, chemical use and

Table I.B.8: Examples of environmental monitoring methodologies regarding wave and tidal energy project installation, operation and decommissioning.

Environmental issues	Monitoring issues / methodologies	References
Coastal sedimentary processes Currents and waves (hydrodynamics)	Numerical modelling	[15][19]
Benthic ecology	Monitoring soft and rocky seabeds: - Qualitative sampling (species composition) - Quantitative sampling (species abundance) Methods for data analysis (application of indices) Video transects and photos of underwater device equipment (e.g. mooring system) and adjacent area	[35] [36]
Fish and shellfish	Video transects and photos in the device site location and in the adjacent area Fishery boat trajectories Artificial reef effect analysis	[36]
Marine mammals	Monitoring cetaceans from land sites Monitoring cetaceans from boats Monitoring cetaceans from air Acoustic surveys	[37] [38]
Birds	Ship and aerial sampling methods	[39]
Electromagnetic fields	Electromagnetic fields measurements in situ	[40][41]
Noise and vibration	Marine mammals noise exposure Pile driving monitoring: Marine Mammal Observer methodologies and requirements and Passive Acoustic Monitoring	[42][43]

management, potential discharges to the sea, maintenance requirements, decommissioning, environmental monitoring and accidental events. The project characteristics are then linked to key impact issues which should be further evaluated as is shown in Table I.B.9.

In a protocol for the environmental assessment of projects to be developed in the marine environment [44] several checklists are proposed for different environmental assessment steps: checklist on the project characteristics; checklist on the surrounding marine environment features; checklist to identify impact importance; checklist to identify mitigation measures.

I.B.5.2 Matrices

A matrix is a grid-like table that is used to identify the interaction between project activities, and help in the identification / judgement / evaluation of the impacts. Generally the project activities / characteristics (if a checklist is used for project description its items can be included here) are displayed along one axis and the environmental characteristics are displayed along the other axis (if a checklist is used for environmental characterization its items can be included here). Using the table, environment-activity interactions can be noted in the appropriate cells or intersecting points in the grid. The impact severity or other features related to the nature of the impact can be highlighted in the cells. There are several well-known types of matrices; two of the most used are briefly described below.

Leopold matrix

Leopold interaction matrix [45] is a comprehensive matrix, which has 88 environmental characteristics along the top axis and 100 project actions on the left hand column. Potential impacts are marked in the appropriate cell and a numerical value can be assigned to indicate their magnitude and importance. Usually the numerical value ranged from 1, for small magnitudes, to 10, for large magnitudes. The assignment of numerical values is based on an evaluation of available facts and data. Similarly, the scale of importance also ranges from 1, for very low interaction, to 10, for very important interaction (Figure I.B.6). Assignment of numerical values for importance is based on the subjective judgement of the interdisciplinary team working on the EIA study.

The matrix approach is reasonably flexible since the number of specified actions and environmental items may increase or decrease depending on the nature and scope of the study. Technically, although this matrix approach is a gross screening technique to identify impacts, it is a valuable tool for explaining / evaluating impacts by presenting a visual display of the impacted items and their causes. Summing the rows and columns that are designated as having interactions can provide deeper insight and aid further interpretation of the impacts. The matrix can also be employed to identify impacts during the various parts of the entire project cycle construction, operation, and even decommissioning phases.

The application of Leopold matrix method has been suggested to ocean energy projects ([22], [46] and [16]). One of these examples is presented in Figure I.B.7 where, in a general sense, environmental factors were previously identified in a baseline study and further evaluated considering the main phases of an ocean energy project.

According to EMECs guidance for developers, the impacts evaluation is made through the use of two main tables: a impact summary table, where the significance of the potential environmental impact is evaluated without (potential impact) and with (residual impact) management or mitigation measures in place; and a summary impact matrix, where the

Table I.B.9: Possible screening checklist for an ocean energy project.

Project characteristics	Yes	No
Project area above xx m ²		✓
Other
Proposed project activities	Yes	No
Dredging		✓
Piling requirements	✓	
Foundation construction		✓
Navigational diversion		✓
Vessel requirements	✓	
Other
Corrosion protection	✓	
Lighting arrangements	✓	
Other
Generation of waste litter	✓	
Vessel requirements	✓	
Other
Affected physical and chemical components	Yes	No
Hydrodynamic changes	✓	
Water quality		✓
Seabed (sediments) quality		✓
Noise	✓	
Waste disposal issues		
Local air quality		✓
Other
Affected biological components	Yes	No
Fish populations		✓
Marine mammal populations	✓	
Spawning habitat		✓
Bird habitat	✓	
Wildlife habitat changes	✓	
Contamination of wildlife		✓
Affected socio-economic components	Yes	No
Employment	✓	
Visual (seascape/landscape)	✓	
Noise		✓
Health		✓

Characteristics and conditions → Project actions ↓	a	b	c	d
A	10 2	8 3	5 3	10 1
B	2 1	5 6	7 5	2 8
C	-3 7	5 9	5 6	10 1
D	2 2	4 1	4 9	3 6

→ Magnitude (strong negative impact)
 → Importance / significance (perhaps locally contained)

Matrix instructions

1. Identify actions across the top that are part of the proposed project;
2. Under each section place a diagonal slash in the cell at the intersection of each component on the side of the matrix where an impact is possible;
3. Indicate the magnitude and importance / significance of the impact with a value from 1 to 10 (1 is low and 10 is high); in some cases and for the magnitude classification a plus (+) for a positive impact and a minus (-) for a negative impact are used.

Figure I.B.6: Leopold matrix instructions (based on [45]).

impacts are ranked against receptors, considering the mechanisms by which impacts may occur. The significance of the potential and residual impacts should be made using established criteria regarding the following categories: major, moderate, minor, negligible, no interaction and positive.

Figure I.B.7: Simple matrix (based on Leopold matrix) for impacts identification of a wave energy converter [46].

Rapid Impact Assessment Matrix

The Rapid Impact Assessment Matrix (RIAM) is a multi-criteria tool to organize, analyse and present the results of a holistic EIA [47]. This matrix method (Figure I.B.9) was developed to bring subjective judgements in a transparent way into the EIA process and was originally developed for comparison of alternatives within one project. Since its development (at the end of the 1990s), the method has been widely tested in many situations and case studies including a renewable energy installation [48]. The potential application of the method to the impacts evaluation of ocean energy projects is a possibility, given its flexibility to be adjusted to different assessment situations and environmental contexts [49]. The basic principle of RIAM is that the impact characteristics form the basis for scoring. The impact is divided into four categories which are scored according to five criteria. Then, an environmental score is calculated based on a three basic formulae and a final classification considering range bands is obtained for each impact. The scores for environmental and social impacts can then be graphically analysed.

I.B.5.3 Geographic Information Systems

Figure I.B.8: Central questions answered by a GIS during an Environmental Impact Assessment process (adapted from [50])

A Geographic Information System (GIS) can be defined as the computer hardware, software and technical expertise that inputs, stores, maintains, manipulates, analyzes and outputs geographically referenced data. A GIS combines the power of spatial database management with high resolution graphic display to effectively present information. GIS outputs can include statistical reports, tables, charts, on-screen displays and high quality maps available in digital format that can be quickly and easily distributed ([50] and [51]). GIS has been widely used in the EIA process (Figure I.B.8). As regards renewable energy, one of the biggest issues facing its exploitation is the selection of suitable sites [52]. One of the most widely used techniques to help on this task is the Multi-Criteria Decision Analysis (MCDA) within the framework of GIS which allows multi competing site selection objectives to be taken into account at once by renewable energy developers. This technique has grown significantly in recent years and several articles have been published in refereed journals since 1990 [53].

Regarding ocean energy, this technique has also been used in site selection of wave farms in e.g. UK [54] and Portugal [55]. It considers a wide variety of environmental and administrative factors (water depth, distance to shore, distance to the electric grid in land, geology and environmental impacts) and assign corresponding weights, which returns a numerical result in a given scale suitability value to be obtained for each location [55]. The criteria definition has two different supporting factors in the multi-criteria analysis: restrictions and weighted factors. Restrictions (e.g. existing underwater cables, marine protected areas, military exercise areas) are used to define exclusion areas that should be eliminated from the analysis; weighted factors (e.g. ocean depth, bottom type, distance to ports, distance to shoreline and to power grid, wave climate characterized by significant wave height, period and power) are evaluated through the relevance or significance of their impact(s) [55]. A GIS method has also been developed to optimise the cable route between a wave farm and the electricity network, in order to keep the underwater cable infrastructure costs to a minimum [56].

Bibliographic reviews show that the most common GIS applications are by far environmental issues including EIA. Although the use of GIS is limited by the availability of data with a good spatial coverage, its application on EIA process can help answering central questions. Examples of GIS applications on several steps of the EIA process (e.g. for ocean energy schemes) are presented in Table I.B.10. GIS have been applied in several environmental assessments of wave energy projects e.g. WaveRoller in the coastal zone of Peniche - Portugal (AW-Energy Oy) and Wave Dragon in Milford Haven Coast, South West Wales (Wave Dragon Wales Lda). GIS may be of particular value for identifying submerged sites that may retain archaeological remains, for example around Orkney [57] and in the North Sea. Layers showing submerged sites combined with identification of features likely to have human activity and current tidal and wave energy maps can indicate areas where remains are likely to be preserved. For tidal stream developments, therefore, is not likely that artefacts will remain at such high energy sites but cables to shore may be laid across them.

Table I.B.10: GIS and Environmental Impact Assessment steps (adapted from [20]).

EIA steps	Objectives of the GIS use	GIS application examples
Screening	Deciding whether a project requires EIA	<p>Maps of the project area can be generated automatically</p> <p>Using GIS to overlay a map of the project and a map of the relevant sensitive areas (in which case an Environmental Impact Statement can be required)</p> <p>In some cases EIA is required if a project is within a certain distance from a certain type of feature (e.g. road, residence area); GIS can be used to create a buffer zone around the project and clip a map containing all the relevant features</p>
Scoping	Identifying impact themes which require further investigation; helping to clarify the spatial scope of the study (In this step GIS can be used in ways not too different from those applicable to screening)	<p>To inform a scoping decision regarding archaeology, creating a 500 buffer around a proposed project and then combine a map of known archaeological sites; the query can be structured to identify areas of archaeological interest falling within the buffer zone that have been submerged following sea-level rise</p> <p>Identification of areas or receptor locations which will require detailed consideration in the assessment of a particular impact</p>
Baseline studies	<p>Building on the spatial information generated as part of the scoping process</p> <p>GIS is ideally suited to organizing and storing multi-disciplinary monitoring data sets to be analyzed, queried and displayed interactively;</p>	<p>GIS can be a powerful tool for displaying and visualizing trends and patterns in spatial data sets:</p> <p>Point-type data relate to specific sample location</p> <p>Spatially continuous data (e.g. noise) can be used to produce a contour (isoline) map</p> <p>Linear data describing features</p> <p>Area data which relate to discrete spatial units (e.g. census data, designated sites and habitat patches)</p>
Impact prediction	Spatial identification of impact magnitude and dimensions	<p>GIS is most suited to deal with the spatial dimension of impacts, and at the simplest level of analysis it can be used to make quantitative estimates of aspects such as:</p> <p>“Land take” caused by the development</p> <p>Length of zones which passes through designated land or seascape areas</p> <p>The number / importance of features (e.g. archaeological finds) that would be lost to the development</p>

Components	A - Criteria that are of importance to the condition, that individually can change the score obtained		B - Criteria that are of value to the situation but should not individually be capable of changing the score obtained			A1+A2 = AT	B1+B2+B3 = BT	A1%BT = RB (RB)		
	A1 Importance of the impact	A2 Magnitude of change and effect	B1 Persistence	B2 Reversibility	B3 Cumulative					
PC Physical / Chemical	4 National / international interests	+3 Major positive benefit +2 Significant improvement +1 Improvement	1 No change/not applicable 2 Temporary 3 Permanent	1 No change/not applicable 2 Reversible 3 Irreversible	1 No change/not applicable 2 Non-cumulative/single 3 Cumulative/synergistic					
BE Biological / Ecological	3 Regional / National interests	0 No change -1 Negative change								
SC sociological / cultural	2 Areas immediately outside of local condition	-2 Significant negative disbenefit or change -3 Major disbenefit or change								
ED Economic / Operational	1 Only to the local condition 0 No importance									

ES: Environmental score	RB: Range bands	Description of range bands
+72 to +108	+E	Major positive change / impacts
+36 to +71	+D	Significant positive change / impacts
+19 to +35	+C	Moderately positive change / impacts
+10 to +18	+B	Positive change / impacts
+1 to +9	+A	Slightly positive change / impacts
0	N	No change / status quo / not applicable
-1 to -9	-A	Slightly negative change / impacts
-10 to -18	-B	Negative change / impacts
-19 to -35	-C	Moderately negative change / impacts
-36 to -71	-D	Significant negative change / impacts
-72 to -108	-E	Major negative change / impacts

RIAM instructions

1. Identify impacts for the components
2. Score impacts according to the main criteria (A and B)
3. Calculate the Environmental Score (ES)
4. Set the Range Band (RB) for each impact
5. Count the number of the same Range Bands per component

Figure I.B.9: Criteria and instructions for RIAM (Rapid Impact Assessment Matrix) application in EIA ([48] and [49]).

I.B.5.4 Mathematical modelling

Models, both mathematical and conceptual, may be of value for predicting and assessing the environmental impact of ocean energy devices and schemes. Geospatial models, such as that developed by CEFAS in the UK [58] can be used to quantify the cumulative impact of ocean energy. Ecological modelling is used extensively to predict the wider scale effects of marine protected areas on both commercial species and the ecosystem. These models should also be applied to understanding the impact of ocean energy via the displacement of both key species and of fisheries. Mathematical models are being used in recent, ongoing, work [59] to investigate the interaction between fisheries and marine renewable energy. The spatial overlap between fisheries and tidal or wave resources can be modelled to investigate the sensitivity of individual species of both fish and invertebrates. Further spatial fishery models can be used to investigate the potential impact (both positive and negative) of marine energy developments as fishery exclusion zones affecting fishery yield and spawning potential.

The risk of collision between marine animals (mammals, fish and diving birds in particular) is difficult to predict and to monitor. In an effort to understand the processes that lead to a risk of collision between animals and the moving parts of marine energy converters and identify gaps in knowledge that require further investigation, encounter and evasion models are being developed and used. Three-dimensional encounter models (used extensively to understand predator-prey interactions of marine animals (e.g. [60], have been modified and used to assess the encounter rate with tidal turbines as well as the risk for individual species [61]. This model showed that encounter rate increases with body size, indicating greater risk to larger animals such as marine mammals. Collisions will result from failure to avoid encounter or to evade a close encounter; thus highlighting the need for more detailed information on spatial and temporal distribution of the species at risk.

Evasion models are also being developed as tools to predict the probability of evasion by fish and marine mammals in response to visual and acoustic stimuli. These models estimate the probability of collision evasion during what can be described as near-field, close encounters between marine animals and tidal stream turbine blades. Such models are based on the extensive literature on the behaviour and locomotion of fish in predator-prey interactions (see review by [62]). So far, a model has been constructed for fish responding to the visual looming stimulus of an approaching turbine blade [63]. By combining computational fluid dynamic models (verified by tank testing) with behavioural models it will be possible to construct models to predict evasion probability in response to transient sound pressure pulses resulting from the bow-wave of an approaching turbine blade. A further challenge will be to extend this approach to cover other marine vertebrates. This may, however, require further behavioural and physiological experiments. Collision evasion models have the potential to assist with the assessment and comparison of relative risks posed by different device types and to inform mitigation measures; for example improving visual and auditory cues to evoke animal evasive responses.

Considering the possibility of reducing collision by behavioural responses at greater distance, an acoustic avoidance model [64] has been developed to predict the range at which marine mammals may detect the sound emitted by tidal turbines over the ambient noise and be able to avoid encounter. This type of model has to be used in conjunction with ambient noise survey data.

Physical models that predict tidal and wave resources (see other Equimar documents) can also be adapted and used to indicate likely areas that will be impacted by reductions in energy input or in some cases increases in tidal energy due to displacement resulting from the drag induced by tidal stream arrays [65].

I.B.6 Environmental key issues

There are a number of recent reports on general environmental effects or potential impacts of wave and tidal energy projects (Table I.B.12). These are exhaustive reviews on the state of the art regarding the list of potential affected environmental receptors, environmental effects / potential impacts, environmental assessment (baseline and monitoring studies), mitigation measures and knowledge gaps.

The information provided in the reports listed in Table I.B.12 is not much different within documents. In most of these reports the effects / potential impacts are listed and analysed through the identification of stressors and receptors³. An important semantic distinction has been considered between an effect of a stressor on a receptor and an impact. Effect does not indicate magnitude or significance whereas impact implicitly deals with severity, intensity, duration and direction of effect. For an effect to be interpreted as an impact, specific investigation is required to determine whether or not the extent of any impact is significant enough to cause change to the receptor. For the majority of the potential effects listed (e.g. on Table I.B.13) current knowledge on the extent of each one is limited. Monitoring will be crucial to classify wave and tidal energy impacts on the marine environment and the process of adaptive management of project monitoring should be encouraged to modify / improve the environmental assessment as knowledge progresses.

Another possible approach to identify impacts is through the mechanisms by which they occur. This approach is proposed in the EMECs guidance for developers [22] and

³Stressors are features of the project that may change the natural environment. Receptors are ecosystem elements with potential for some form of response to the stressor.

can be used as a checklist to ensure that all potential impacts from the devices and associated operations are being assessed. Whatever the approach selected for impacts identification, the significance of each of them should always be judged against receptors. Table I.B.13 shows the most widely discussed issues regarding the environmental effects of wave and tidal energy technologies on the environment. It is important to stress that EIA study requirements are site and project specific and should be defined at the EIA scoping stage; therefore, the environmental issues list presented herein should be considered non-exhaustive and non binding.

Despite the considerable amount of information available regarding the identification and analysis of potential environmental impacts, there is still a need to collect and analyse more data to reduce effects uncertainties, prioritize impacts and improve best practices on project development and deployment. A review of the uncertainties and information gaps regarding wave and tidal energy impacts is presented in Equimar Deliverable 6.3.2 (this deliverable also includes information on the research groups and ongoing projects regarding the uncertainties identified).

Table I.B.12: Examples of recent reports on reviews of environmental key issues of wave and tidal energy developments.

Title	Year	Country/entity	Description	Reference
Protocol to develop an environmental impact study of wave energy converters	May 2010	Spain, AZTI Tecnalía	Reviews the likely environmental effects of wave energy and presents a risk management framework to predict, prevent and deal with the environmental impacts of wave energy deployment of in Spain	[44]
Marine renewables licensing manual Part IV Wave and Tidal Annex	April 2010	Scotland, Marine Scotland (MS)	A comprehensive guidance for licence applications of wave and tidal energy projects. This annex provides detailed information on the potential impacts (offshore and onshore) that might need to be considered during the EIA and the methods by which the impacts should or may be assessed	[26]
Report to the congress on the potential environmental effects of marine and hydrokinetic energy technologies	December 2009	USA, U.S. Department of Energy (DOE)	Describes the technologies that are being considered for development, their potential environmental impacts and options to minimize or mitigate the impacts, and the potential role of environmental monitoring and adaptive management in guiding their deployment	[15]
Worldwide synthesis and analysis of existing information regarding environmental effects of alternative energy uses on the outer continental shelf	July 2007	U.S.A., U.S. Department of the Interior, Minerals Management Service (MMS)	Identifies, collect, evaluate and synthesize existing information on offshore alternative energy activities for public acceptance, potential environmental impacts, mitigation measures, physical and numerical models for environmental impacts prediction and information gaps	[30]
Ecological effects of wave energy development in the Pacific Northwest	October 2007	U.S.A., U.S. Department of Commerce, National Oceanic and Atmospheric Admin-	Presents the results of a workshop held in Oregon to develop an initial assessment of potential impacting agents and ecological effects of wave energy development and formulate general concep-	[16]

Table I.B.13: Key environmental issues to be considered in the environmental assessment.

Receptors	Stressors	Effects and / or ecological issues
Physical environment Pelagic habitat Benthic habitat Fish and fisheries Marine birds Marine mammals Humans (users)	Physical presence of the devices Chemical effects Lighting Acoustics Electromagnetic fields Cumulative effects	<ul style="list-style-type: none"> • Alteration of currents and waves due to the energy extraction and or physical presence of the devices • Alteration of substrates and sediment transport and deposition which may alter coastline processes and morphology • Benthic habitat disturbance or destruction • Changes to factors such as nutrients, temperature, light levels, turbidity (suspended sediments) • Water contamination due to e.g. effluent or waste discharge, oil leaks • Collision, strike, entrapment and entanglement of marine invertebrates, fish, mammals and birds with the equipment e.g. device, mooring lines • Interference with animal movements and migration • Displacement of marine species • Noise disturbance • Effects of electromagnetic fields in elasmobranchs fish (sharks, rays and skates) orientation and reproduction

References

- [1] “Scottish Marine Renewables: Strategic Environmental Assessment. Environmental report,” tech. rep., The Scottish Government, 2007. Available at: <http://www.seaenergyscotland.co.uk/ScopingConsultation.htm>.
- [2] “Future Leasing for Offshore Wind Farms and Licensing for Offshore Oil & Gas and Gas Storage,” tech. rep., Department of Energy and Climate Change (DECC), 2009.
- [3] “Bay of Fundy Ecosystem Partnerships Strategic Environmental Assessment. New Brunswick Joint Response,” tech. rep., New Brunswick Department of Energy, 2009.
- [4] J. J. Cochrane and V. T. Covello, “Risk Analysis: A guide to principles and methods for analyzing health and environmental risks,” tech. rep., Executive Office of the President of the United States, 1989.
- [5] P. Morris and R. Therivel, *Methods of environmental impact assessment*. Routledge, 3rd edition ed., 2009.
- [6] B. Ram, “An Integrated Risk Framework for Large Scale Deployments of Renewable Energy,” *ASME Conference Proceedings*, vol. 2009, no. 43444, pp. 1199–1204, 2009.
- [7] “Environmental management Life cycle assessment Principles and framework. ISO 14040:2006,” 2006.
- [8] “Environmental management Life cycle assessment Requirements and guidelines. ISO 14044:2006,” 2006.
- [9] “Life cycle assessment of offshore and onshore sited wind power based on Vesta V90-3.0 MW turbines.” 2006.
- [10] J. Weinzettel, M. Reenaas, C. Solli, and E. G. Hertwich, “Life cycle assessment of a floating offshore wind turbine,” *Renewable Energy*, vol. 34, no. 3, pp. 742 – 747, 2009.
- [11] S. Banerjee, L. J. Duckers, R. Blanchard, and B. K. Choudhury, “Life cycle analysis of selected solar and wave energy systems,” *Advances in Energy Research*, vol. 1, 2006.
- [12] C. A. Douglas, G. P. Harrison, and J. P. Chick, “Life cycle assessment of the Seagen marine current turbine,” *Proceedings of the Institution of Mechanical Engineers, Part M: Journal of Engineering for the Maritime Environment*, vol. 222 (1), pp. 1–12, 2008.

- [13] R. P. M. Parker, G. P. Harrison, and J. P. Chick, "Energy and carbon audit of an offshore wave energy converter," *Proceedings of the Institution of Mechanical Engineers, Part A: Journal of Power and Energy*, vol. 221 (8), pp. 1119–1130, 2007.
- [14] H. Soerensen, S. Naef, S. Anderberg, and M. Hauschild, "Life Cycle Assessment of the Wave Energy Converter: Wave Dragon," in *Int Conf Ocean Energy. Fron Innovation to Industry. OTTI, Bremerhaven, Germany*, 2006.
- [15] "Report to congress on the potential environmental effects of marine and hydrokinetic energy technologies. Wind and hydropower technologies program. Energy efficiency and renewable energy.," tech. rep., U. S. Department of Energy (DOE), 2009.
- [16] "Ecological effects of wave energy in the Pacific Northwest," tech. rep., U.S. Dept. Commerce, NOAA Tech, 2008. <http://spo.nwr.noaa.gov/tm/Wave>
- [17] C. Oram and C. Marriott, "Using Adaptive Management to Resolve Uncertainties for Wave and Tidal Energy Projects," *Oceanography*, vol. 23, no. 2, p. 92, 2010.
- [18] "Marine Renewables Licensing Manual Consenting, EIA, HRA Guidance for Marine renewable Energy Developments in Scotland. Part three EIA EIA & HRA Guidance," tech. rep., Xodus Aurora and European Marine Energy Centre (EMEC), 2010. <http://www.scotland.gov.uk/Topics/marine/Licensing/marine/LicensingManual>.
- [19] "Offshore Wind Farms Guidance note for Environmental Impact Assessment in respect of FEPA and CPA requirements. Version 2," tech. rep., Centre for Environment, Fisheries and Aquaculture Science, CEFAS, 2004. Crown Copyright. <http://www.cefas.co.uk/publications/files/windfarm-guidance.pdf>.
- [20] P. Morris and R. Therivel, *Methods of environmental impact assessment (The natural & built environment series)*. Spon press, Taylor & Francis Group, London & New York., 2 ed., 2005.
- [21] R. Morgan, *Environmental impact assessment: a methodological perspective*. Kluwer Academic Publishers, 1999.
- [22] "Environmental Impact Assessment (EIA) Guidelines for developers at the European Marine Energy Centre," tech. rep., European Marine Energy Centre (EMEC), 2005. available at: http://www.emec.org.uk/pdf/EMEC_EIA_Guidelines.pdf.
- [23] T. Prins, F. Twisk, M. J. van den Heuvel-Greve, T. Troost, and J. van Beek, "Development of a framework for Appropriate Assessments of Dutch offshore wind farms," tech. rep., Deltares, 2008. <http://www.noordzeeloket.nl/Images/Generieke>
- [24] "Nature conservation guidance on offshore windfarm development. Version 1.9," tech. rep., Department for Environment for Environment, Food and Rural Affairs (DEFRA), 2005.
- [25] J. Davies, J. Baxter, M. Bradley, D. C. J. Khan, E. Murray, W. Sanderson, C. Turnbull, and M. Vincent, "Marine Monitoring Handbook. UK Marine SACs project," tech. rep., Joint Conservation Nature Conservation Committee., 2001.
- [26] "Marine Renewables Licensing Manual Consenting, EIA, HRA Guidance for Marine renewable Energy Developments in Scotland. Part four Wave and Tidal Annex.," tech. rep., Xodus Aurora and European Marine Energy Centre (EMEC), 2010. <http://www.scotland.gov.uk/Topics/marine/Licensing/marine/LicensingManual>.

- [27] S. Derous, M. Agardy, H. Hillewaert, K. Hostens, G. Jamieson, L. Lieberknecht, J. Mees, I. Moulart, S. Olenin, D. Paelinckx, *et al.*, “A concept for biological valuation in the marine environment,” *Oceanologia*, vol. 49, no. 1, pp. 99–128, 2007.
- [28] G. Peterson, R. Gemmell, and J. Schofer, “Assessment of environmental impacts: multidisciplinary judgements of large-scale projects,” *Ekistics*, vol. 218, pp. 23–30, 1974.
- [29] “Environmental protection and management for wave and tidal energy convertors: best practice approaches,” tech. rep., European Marine Energy Centre (EMEC), 2008. Report of the EMEC workshop on 3 September, 2008. DOE/GO-102009-2955. http://www1.eere.energy.gov/windandhydro/pdfs/doe_eisa_633b.pdf.
- [30] J. Michel and U. S. M. M. Service, *Worldwide synthesis and analysis of existing information regarding environmental effects of alternative energy uses on the outer continental shelf*. US Dept. of the Interior, Minerals Management Service, 2007. <http://hmsc.oregonstate.edu/waveenergy/MMSAEFINALSYNTHESISREPORT.pdf>.
- [31] “Best practices guidelines: consultation for offshore wind energy developments,” tech. rep., British Wind Energy Association (BWEA), London, 2002.
- [32] M. Portman, “Involving the public in the impact assessment of offshore renewable energy facilities,” *Marine Policy*, vol. 33, no. 2, pp. 332–338, 2009.
- [33] L. Hansen, K. Hammarlund, H. Sørensen, and L. Christensen, “Public acceptance of wave energy,” in *Proceedings from the 5th European Wave Energy Conference*, (University College Cork, Ireland), 2003.
- [34] P. Devine-Wright, “Enhancing local distinctiveness fosters public acceptance of tidal energy: A UK case study,” *Energy Policy*, vol. 39, pp. 83–93, 2010.
- [35] “Guidelines for the conduct of benthic studies at aggregate dredging sites,” tech. rep., Centre for Environment, Fisheries and Aquaculture Science (CEFAS), Department for Transport, Local Government and the Regions., 2002. <http://www.marbef.org/qa/documents/ConductofsurveysatMAEsites.pdf>.
- [36] K. Andersen, A. Chapman, N. Hareide, A. Folkestad, E. Sparrevik, and O. Langhamer, “Environmental Monitoring at the Maren Wave Power Test Site off the Island of Runde, Western Norway: Planning and Design,” *Proceedings of the 8th European Wave and Tidal Energy Conference*, 2009.
- [37] D. Faustino, “Approaches to marine mammal monitoring at marine renewable energy developments Final Report,” tech. rep., Sea Mammal Research Unit (SMRU), University of St. Andrews, 2010.
- [38] D. E. Gaskin, “Monitoring protocol for marine mammals in Canadian waters,” tech. rep., Marine biodiversity monitoring. Department of Zoology, University of Guelph, Ontario. Canada.
- [39] C. Camphuysen, A. Fox, M. Leopold, and I. Petersen, “Towards standardised seabirds at sea census techniques in connection with environmental impact assessments for offshore wind farms in the UK,” *Den Burg*, 2003.

- [40] A. Gill, I. Gloyne-Philips, K. Neal, and J. Kimber, "The potential effects of electromagnetic fields generated by sub-sea powercables associated with offshore wind farm developments on electrically and magnetically sensitive organisms a review," tech. rep., Cowrie, 2005.
- [41] A. Gill, Y. H. I. Gloyne-Philips, J. Metcalf, V. Quayle, J. Spencer, and V. Wearmouth, "EMF-sensitive fish response to EM emissions from sub-sea electricity cables of the type used by the offshore renewable energy industry - Final report," tech. rep., Cowrie, 2009. Available online at: http://www.offshorewindfarms.co.uk/Assets/COWRIE_Final_compiled.pdf.
- [42] B. Southall, A. Bowles, W. Ellison, J. Finneran, R. Gentry, C. Greene Jr, D. Kastak, D. Ketten, J. Miller, P. Nachtigall, *et al.*, "Marine mammal noise exposure criteria: Initial scientific recommendations.," *Aquat Mammals*, vol. 33, pp. 411–414, 2007.
- [43] "Statutory nature conservation agency protocol for minimising the risk of disturbance and injury to marine mammals from piling noise," tech. rep., Joint nature conservation Committee (JNCC), June 2009.
- [44] J. Bald, A. del Campo, J. Franco, I. Galparsoro, M. Gonzalez, P. Liria, I. M. A. Rubio, O. Solaun, A. Uriarte, M. Comesaa, A. Cacabelos, R. Fernandez, G. Mndez, D. Prada, and L. Zubiate, "Protocol to develop an environmental impact study of wave energy converters," *Revista de Investigacin Marina*, vol. 17, no. 5, pp. 62–138, 2010. <http://www.azti.es/rim/component/content/article/28.html>.
- [45] L. Leopold, F. Clarke, B. Hanshaw, and J. Balsley, "A Procedure for Evaluating Environmental Impact.," 1971.
- [46] C. Huertas-Olivares, "Large scale Environmental Impact Assessment of wave energy devices A guidance document," tech. rep., WAVETRAIN project Research Training Network Towards Competitive Ocean Wave Energy, 2007. MRTN-CT-2004-50166.
- [47] C. Pastakia and A. Jensen, "The rapid impact assessment matrix (RIAM) for EIA," *Environmental Impact Assessment Review*, vol. 18, no. 5, pp. 461–482, 1998.
- [48] M. Kuitunen, K. Jalava, and K. Hirvonen, "Testing the usability of the Rapid Impact Assessment Matrix (RIAM) method for comparison of EIA and SEA results," *Environmental Impact Assessment Review*, vol. 28, no. 4-5, pp. 312–320, 2008.
- [49] A. Ijäs, M. Kuitunen, and K. Jalava, "Developing the RIAM method (rapid impact assessment matrix) in the context of impact significance assessment," *Environmental Impact Assessment Review*, vol. 30, no. 2, pp. 82–89, 2010.
- [50] "Understanding GIS: the ARC/INFO method.," tech. rep., ESRI (Environmental Research Systems Institute), 1995. www.ciensin.org/docs/005-331..html.
- [51] D. M. Heimiller and S. Haymes, "Geographic Information Systems in support of wind energy activities at NREL (National Renewable Energy Laboratory)," *39th AIAA Aerospace Sciences Meeting*, 2001.
- [52] S. Baban and T. Parry, "Developing and applying a GIS-assisted approach to locating wind farms in the UK," *Renewable Energy*, vol. 24, no. 1, pp. 59–71, 2001.

- [53] J. Malczewski, "GIS-based multicriteria decision analysis: a survey of the literature," *International Journal of Geographical Information Science*, vol. 20, no. 7, pp. 703–726, 2006.
- [54] S. Graham, A. Wallace, and G. Connor, "Geographical Information System (GIS) Techniques applied to network integration of marine energy," in *Proceedings of the Universities Power Engineering Conference*, vol. 38, pp. 678–681, 2003.
- [55] A. Nobre, M. Pacheco, R. Jorge, M. Lopes, and L. Gato, "Geo-spatial multi-criteria analysis for wave energy conversion system deployment," *Renewable Energy*, vol. 34, no. 1, pp. 97–111, 2009.
- [56] R. Prest, T. Daniell, and B. Ostendorf, "Using GIS to evaluate the impact of exclusion zones on the connection cost of wave energy to the electricity grid," *Energy Policy*, vol. 35, no. 9, pp. 4516–4528, 2007.
- [57] S. Dawson and C. Wickham-Jones, "Sea level change and the prehistory of Orkney," *Antiquity*, vol. 81, p. 312, 2007.
- [58] V. Stelzenmüller, J. Lee, A. South, and S. Rogers, "Quantifying cumulative impacts of human pressures on the marine environment: a geospatial modelling framework," *Marine Ecology Progress Series*, vol. 398, pp. 19–32, 2010.
- [59] M. Bell and J. Side, "Fishery Interactions with Marine Renewable Energy Developments.," tech. rep., International Centre for Island Technology, HeriotWatt University, 2010. Presentation given at MASTS/MREDS Workshop (20th-22nd October 2010). Available at: <http://www.mreds.co.uk/downloads/Mike>
- [60] K. Bailey and R. Batry, "A laboratory study of predation by *Aurelia aurita* on larval herring (*Clupea harengus*): experimental observations compared with model predictions," *Marine Biology*, vol. 72, no. 3, pp. 295–301, 1983.
- [61] B. Wilson, R. Batty, F. Daunt, and C. Carter, "Collision risks between marine renewable energy devices and mammals, fish and diving birds," tech. rep., 2007. Report to the Scottish Executive: Scottish Association for Marine Science, Oban, Scotland, PA37 1QA. http://www.seaenergyscotland.net/public_docs/Appendix
- [62] R. Batty and P. Domenici, "Predator-prey relationships in fish and other aquatic vertebrates: kinematics and behaviour," *Biomechanics in Animal Behaviour* (ed. by P. Domenici and RW Blake), BIOS Scientific Publishers, Oxford, England, pp. 237–257, 2000.
- [63] R. Batty and B. Wilson, "Predicting the abilities of marine vertebrates to evade collision with tidal stream turbines.," *3rd International Conference on Ocean Energy*, 2010.
- [64] C. Carter, "Marine Renewable Energy Devices: A Collision Risk for Marine Mammals?," MSc Thesis. University of Aberdeen., 2007.
- [65] M. Easton, D. Woolf, and S. Pans, "An Operational Hydrodynamic Model of a key tidal-energy site: Inner Sound of Stroma, Pentland Firth (Scotland, UK)," *3rd International Conference on Ocean Energy*, 2010.

Chapter II.A

Tank Testing

Summary

At present no common practices are adopted to assess the performance and operational characteristics of conceptual and small prototype wave and tidal energy devices when tested within controlled laboratory environments. Information acquired from this early stage assessment may be used to secure development funding or promote a specific wave or tidal energy device. Since no standards exist, the data produced may be misinterpreted or inaccurately presented, which in turn may lead to failure to live up to performance expectations, as devices scale up in size. This report builds on Deliverable 3.3 which identified limitations of current practices adopted for tank testing of small prototype devices. The recommendations contained herein constitute minimum set of best practices for device testing and benchmarking. The protocol contains explicit Design of Experiment and Uncertainty Analysis techniques. Particular emphasis has been placed on repeatability, quantification of uncertainty, estimation of accuracy and elimination of laboratory specific effects.

II.A.1 Introduction - Experimental Good Practice

This document sets out a Protocol for tank testing wave and tidal marine energy converters. It contains explicit Design of Experiment and uncertainty analysis methodologies which should be considered the minimum requirement for tank testing work. This places particular emphasis on repeatability, quantification of uncertainty, estimation of accuracy and elimination of laboratory specific effects.

Purpose of this Document

Protocol Requires Developer must deliver bounded uncertainty:

Final result [e.g. C_P , C_T , η , ... inflow] 5% full scale with a 95% confidence level

Protocol Provides Guidelines for and Means of identifying, reducing and reporting uncertainty in experimental results:

- Minimum Uncertainty Analysis Requirements
- Potential Design of Experiment Methodologies
- Specific techniques for Wave and Tidal technologies

The purpose of an experiment is to generate physical data to test a hypothesis. The purpose of experimental good practise, manifest in Design of Experiment (DoE), is to

optimise in advance an experimental process in order to generate the maximum quantity of high quality data - in other words maximising value for money for a particular experiment.

In the context of EquiMar, the experimental procedures are those which will provide performance data on the performance of conceptual marine energy devices, however the DoE process as well as that of the Uncertainty Analysis are common to a very wide range of engineering fields and thus the domain is well documented and processes and procedures are widely accepted.

The procedures outlined in this document are primarily a synthesis of those promulgated in

- the proceedings and procedures of the International Towing Tank Conference (henceforth referred to as ITTC) [1]
- the American Institute of Aeronautics and Astronautics (henceforth AIAA) [2]
- the ISO Guide to the Expression of Uncertainty in Measurement [3] and the NIST Guidelines for Evaluating and Expressing the Uncertainty of NIST Measurement Results (henceforth GUM) [4]
- the ISO International Vocabulary of Basic and General Terms in Metrology (henceforth VIM) [5]
- the NIST Reference on Constants, Units and Uncertainty [6]
- the NIST/SEMATECH e-Handbook of Statistical Methods [7].

The core purpose of these procedures is thus to allow an experimental test result to be stated in the standard form (as defined in the VIM) of either a **standard uncertainty**, i.e.:

$$(\text{Result}) : x(\text{units})[\text{with a}] \text{standard uncertainty of } u_c(\text{units})$$

or an **expanded uncertainty**, i.e.:

$$(\text{Result}) : x \pm U(\text{units})$$

such that the uncertainty is a combination of all identified, reduced where possible and accounted for uncertainties associated with the experiment. The expanded uncertainty is related to the standard uncertainty via the coverage factor k , itself calculated (under the assumption of normally distributed data) from the Student t -statistic where degrees of freedom is the number of samples or tests minus 1:

$$U = k u_c \text{ where } k = t_{\alpha/2}(v) \text{ for } v \text{ degrees of freedom}$$

Qualitative and quantitative guidance is provided in Deliverable 3.3 [8] on potential sources of experimental error, and minimum requirements are contained herein as to how these are included and presented in a result statement. Further generic guidance is given to identifying common error types, and on to how to design and undertake an experiment to reduce or eliminate these errors and on how to present the result. Later sections of this document detail specific requirements, tests and methods associated with experiments on wave and tidal devices to further support these generic procedures.

The recommendation of this Protocol is that all experiments are conducted in such a manner that the reported performance of a prototype device is stated with a precision of 5% at a confidence level of 95%. **In plain English this requires that 95 times out of 100 the error of a reported value is no greater than 5% of the true value.** This requires that the standard uncertainty is calculated for large degrees of freedom such that the coverage factor, k , is 0.96 (approximately 2), corresponding to approximately 95% coverage.

Therefore this document should be used alongside Deliverable 3.3 [8] to identify error sources, calculate their contribution to overall uncertainty and focus efforts in the most efficient manner into reducing it in line with this recommendation. Furthermore, it is essential that experiments are conducted in such a way that any reported causal relationship is actually present in the physics. To this end, some basic design of experiment methodologies are described to aid construction of the test schedule.

II.A.1.1 Purpose of the Test

It is likely that the majority of tank test programmes will be undertaken in order to achieve one of the following objectives.

Proof of Concept Unstructured experiment to answer the question “**does it work?**” at some fundamental level. Very short tests likely to proceed in a trial and error manner, often unaccompanied by a mathematical model.

Example: determine whether a wave device moves in a wave field.

Comparison Determination of the **significance of levels of a single variable**, identified in advance, on the response.

Example: determine the $C_P - \lambda$ characteristic of a simple rotor¹

Screening Identification of **a subset of the most important variables**, from a larger set of candidate variables that have been identified in advance, on the response.

Example: identify the key geometric performance variables for a novel wave energy device.

Response Surface Modelling Optimisation via identifying relationships and estimate interactions between multiple variables and responses, and specifically identify the levels of the important variables which would produce an optimum response. Quadratic surfaces can be fitted to data providing local maximum/minimum.

Example: reduce the two responses pitch magnitude and roll magnitude as a function of H_s and T_z for a wave energy device.

Model Fitting Identification of a high quality **mathematical model** in terms of goodness of model parameter estimates.

Example: estimate the numerical models of the two responses C_P and C_T as a function of blade pitch and TSR for a novel tidal turbine rotor.

Once the objectives of the test have been identified, it is possible to select appropriate uncertainty analysis and design of experiment methodologies.

¹ λ is actually made up of 2 factors: inflow and angular velocities.

II.A.1.2 Outline Test Procedure

Although every test procedure is individual, this protocol recommends the adoption of the general outline test process formulated by the AIAA [2] and adopted by the ITTC [9]. This provides a means of introduction and integration of uncertainty assessment into each phase of the experimental process, with appropriate decision points and reporting.

The ITTC states that *this philosophy of testing, rigorous application/integration of uncertainty assessment methodology into the test process and documentation of results should be the foundation of all [towing] tank experiments.*

Description

The stages of the flow chart in Figure 27 correspond to the various subsections in this document, which are identified in the following extended summary. This breakdown of the pre-test procedures identifies a list of what should be considered mandatory stages, but which will generally be undertaken automatically as part of a well thought out experimental process, therefore do not constitute a significant or onerous burden in time or resource. In common with the technical documents of the EquiMar project, this document considers parts of the 5 stage development schedule, specifically Stage 1: Concept Appraisal and Stage 2: Large Scale Tank Testing.

The following list sets out the stages whose documentation is required under this Protocol.

1. **Requirement:** Identify test objectives
 - Stage 1: Functionality/Proof of Concept; Comparison; Factor Screening...
 - Stage 2: Optimisation; Variation Reduction; Adding Robustness; Model Identification...
2. **Requirement:** Identify facility and process (e.g. towing tank -> thrust and power measurements whilst towing)
 - Ascertain capabilities and proficiencies of facility
 - Range and quality of measurements & instrumentation
 - Range and types of tests
 - Calibration capabilities
3. **Requirement:** Identify primary and secondary model(s)
 - Write data reduction equation(s)
 - Perform sensitivity analysis using instrument tolerances & estimated experimental biases -> estimate, tolerate & correct
 - Focus resources on reducing estimated result bias below 5%
4. **Requirement:** Design of Experiment
 - Statistical Design of Experiment for maximum quality (minimised uncertainty) of data and maximum robustness of interpretation of results
 - Different DoE approaches to be taken depending on objectives, number of factors etc.

Flow Chart

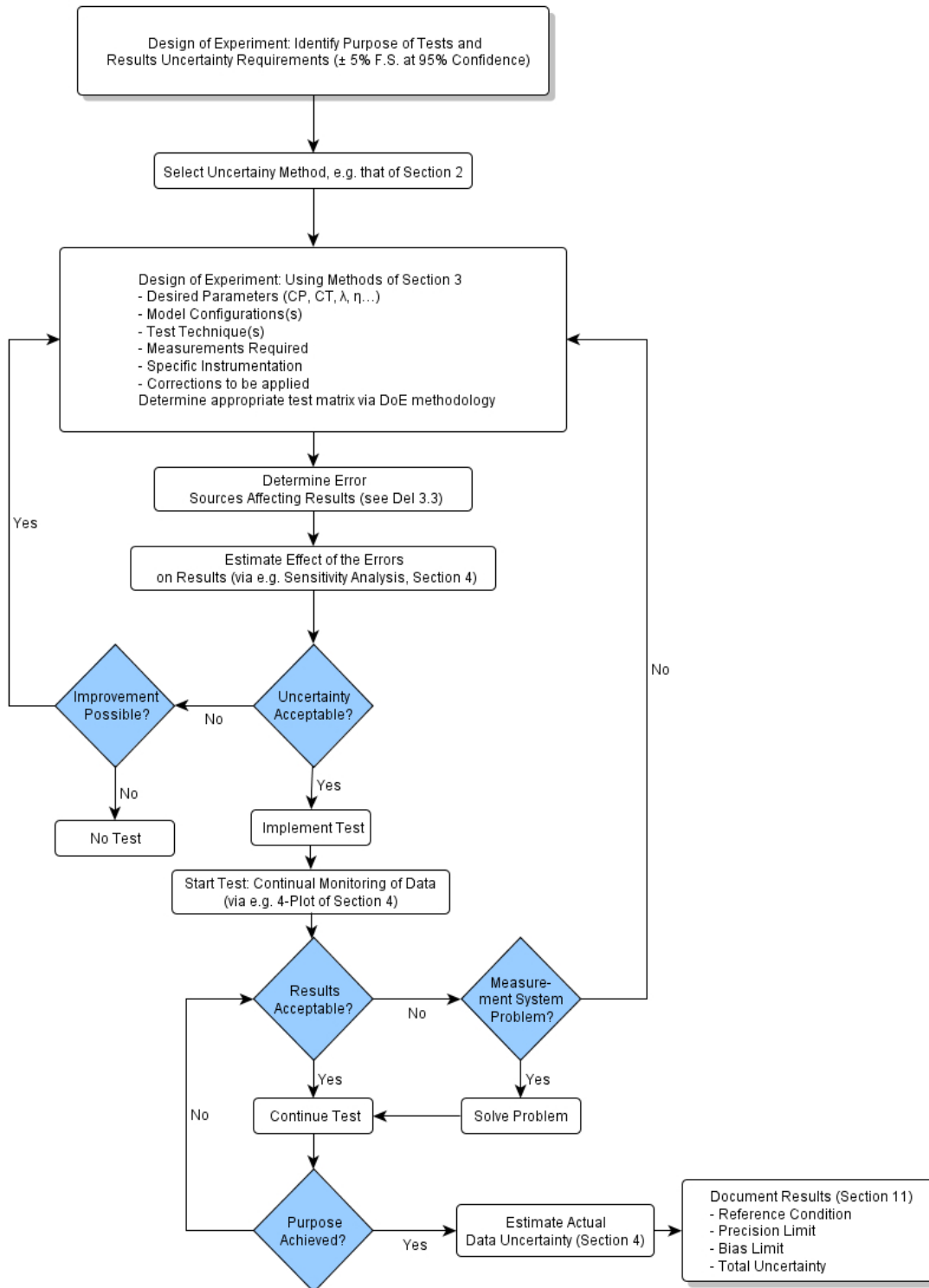

Figure II.A.1: Flow chart of experimental process, indicating decision points and information sources. Adapted from ITTC Procedure 7.5-02-01-02 [10].

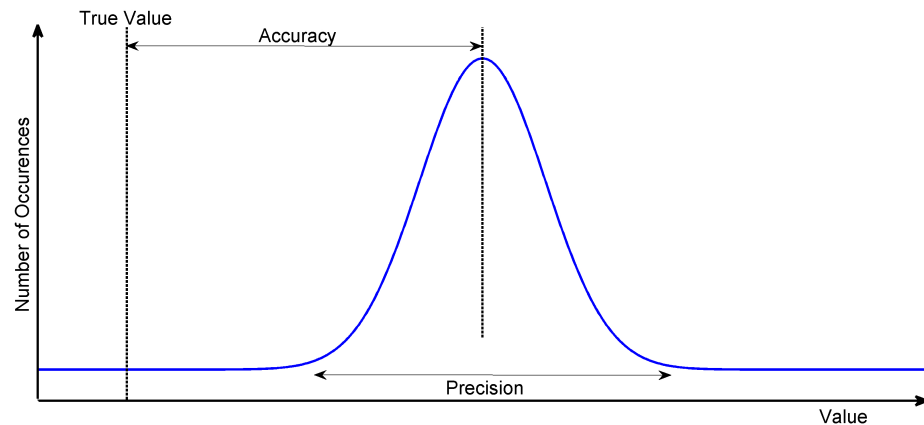

Figure II.A.2: Illustration of Precision and Accuracy components of experimental uncertainty, and also the notion of a probability density function.

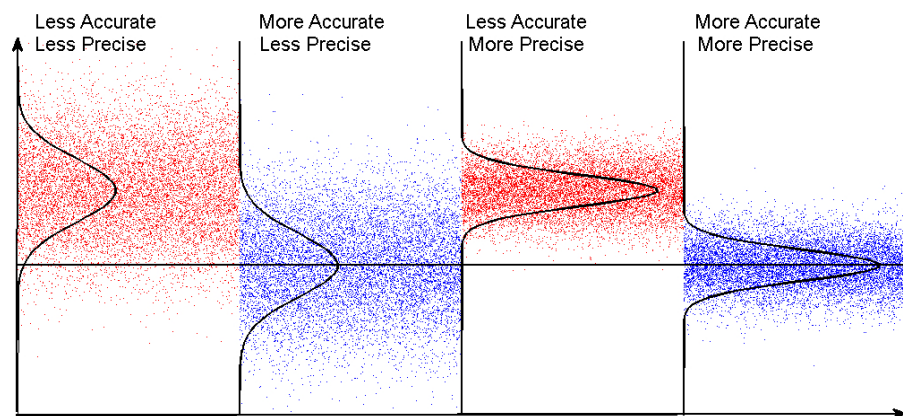

Figure II.A.3: Illustration of qualitative Precision and Accuracy components of experimental uncertainty, and also the effects on a probability density function.

II.A.2 Quality and Accuracy of Results

The quality of an experimental measurement can be quantified in terms of how much an estimate of a parameter value is in error from the true value. Unfortunately the true value of the parameter is either not known (in the case of an experimental test) or is only known for a limited subset of a much larger population of influencing factor values (in the case of a calibration test). Therefore quality of a measurement must be estimated using an uncertainty analysis to compute the error in the result.

Traditionally, the error is decomposed into a precision component, accounting for random scatter about some mean value, and an accuracy component, which when quantified is known as bias, that accounts for a shift in the mean value from the true value. These concepts are illustrated in the following figures:

When considering time series data, the distribution around the mean values may appear as follows:

The uncertainty analysis (UA) methodology of Section 15 provides a basic framework for estimation of the uncertainty terms (e.g. the combined precision and bias errors) in an

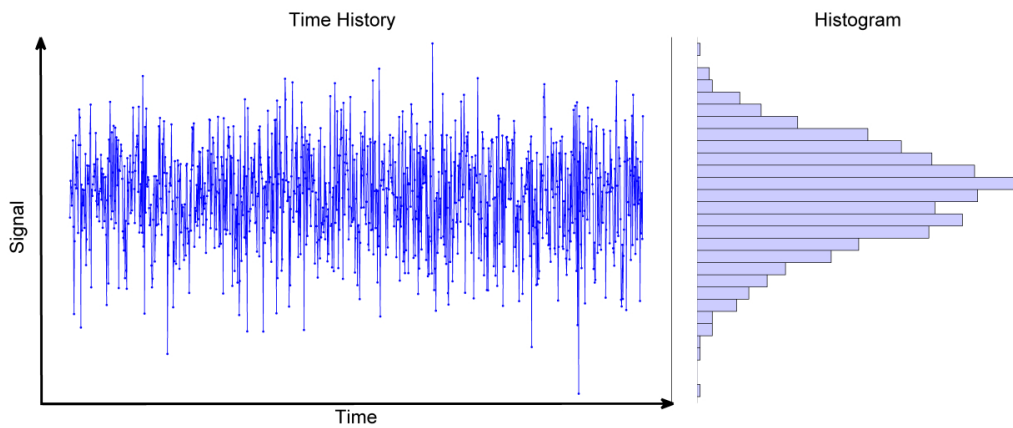

Figure II.A.4: Illustration of a noisy time series of data, and the associated histogram of values.

experimental measurement.

II.A.2.1 Statistical Definitions

A number of statistical properties can be used to describe the data:

Given a series of n measurements of the same measurand, in a single test, the **sample mean** is the mathematical average of the data values, and is the point at which the expected value would occur:

$$\bar{x} = \frac{1}{n} \sum_{i=1}^n x_i \quad (\text{II.A.1})$$

The experimental **sample standard deviation** is the mean distance between the mean of the data values and the values themselves and is a measure of the spread of the values in the sample:

$$s = \sqrt{\frac{1}{(n-1)} \sum_{i=1}^n (x_i - \bar{x})^2} \quad (\text{II.A.2})$$

If a number, M , of tests have been performed in order to reduce the variance in x and thus the standard deviation, then a number of quantities describing the sample distribution, that is the distribution of a particular test statistic calculated for a test sample of set size, can be determined. The Central Limit Theorem posits that as the number, M , of tests are increased, the distribution of test statistics will tend to normal, in other words that the distribution of a test statistic, e.g. the mean, is normally distributed, regardless of the distribution of the population from which it was drawn. This allows the use of an assumption of normality on test statistics, greatly easing statistical uncertainty analysis.

The experimental **standard deviation of the mean** is the standard deviation of the different experimental test sample means. This is also sometimes (mistakenly) known as the standard error of the mean, and is equivalent to the standard uncertainty:

$$u(x_i) = s(\bar{x}) = \sqrt{\frac{1}{n(n-1)} \sum_{i=1}^n (x_i - \bar{x})^2} \quad (\text{II.A.3})$$

with x_i being the result of the i^{th} measurement. If multiple test results are not available, then an estimate of the standard deviation of the mean can be computed from a single sample of n observations by the following:

$$u(x) = \frac{s(x)}{\sqrt{n}} \quad (\text{II.A.4})$$

Clearly, as the number of samples in the test increase, the estimated standard deviation of the mean decreases.

This **equation** is strictly only valid for normally distributed data or data made up of statistical quantities adhering to the central limit theorem.

If the standard deviation is sought over M tests, which in practice requires that the sample standard deviations are of the same magnitude, then the pooling formula may be used to calculate the weighted average of the standard deviations:

$$s_p = \sqrt{\frac{\sum_{j=1}^M ((n_j - 1)s_j^2)}{\sum_{j=1}^M (n_j - 1)}} \quad (\text{II.A.5})$$

Coverage & Expanded Uncertainty

A coverage factor, k , is used to re-scale the combined uncertainty - which is essentially one standard deviation of the result - such that the uncertainty may be stated at other confidence levels than approximately 68% (the confidence level for one standard deviation). This results in the expanded uncertainty, as defined in section 12. Coverage factors typically applied to a normal distribution are:

- $k = 1$ For a confidence level of 68%
- $k = 1.64$ For a C.L. of 90%
- $k = 2$ For a C.L. of 95% [the requirement of this protocol]
- $k = 2.58$ For a C.L. of 99%
- $k = 3$ For a C.L. of 99.7%

These coverage factors correspond to the Students t statistic, for an infinite number of degrees of freedom. In cases when the number of samples is significantly fewer than that which may be considered “infinite” (fewer, say, than 30 observations) then the t -statistic with the appropriate degrees of freedom should be used to scale the combined uncertainty.

II.A.2.2 Frequency Domain Analysis

In performing the discrete signal analysis using FFT some assumptions are implicitly made:

- The N digital data is decomposed into N linear components, each at a frequencies going from 0 to N/T_0 (T_0 being the length of the time series).

- The Nyquist frequency (corresponding to the $(N/2 - 1)^{th}$ component, which roughly half the sampling frequency) sets the limit of what frequency components can be resolved. In others words, the first half of the linear components represents the ‘true’ part of the spectrum, while the second half contains the folding components (aliasing). Thus only phenomena with a frequency lower than the Nyquist frequency can be detected by the FFT analysis. Any phenomena at higher frequencies will be ‘folded’ back into the true components, which will then be contaminated. Another way of expressing the Nyquist frequency criteria, is to say that at least two data points are needed to describe an oscillation. This is enough because it is already assumed that the oscillation is harmonic.
- The signal is assumed to be periodic with the period T_0
- The data is describing a stationary process.
- The signal is assumed to be a sum of harmonics.

From the above it follows that the obtained ‘true’ (single sided) spectrum will have $N/2$ components, which corresponds to a frequency width of $1/T_0$. However, it can be shown that the spectral components in this case will have as large a variance as the value of the component itself

$$\text{Var}(S'(f)) = \frac{S(f)}{\sqrt{P}} \quad (\text{II.A.6})$$

P being number of estimates of $S'(f)$ (subtimeseries)). To lower the variance on the individual spectral components more estimates are needed per frequency. This is normally obtained by division of the original timeseries into a number of subtimeseries, performing the FFT on the individual subtimeseries, and then averaging the spectral estimates for the individual frequencies. (An alternative can be to simply averaging neighbouring frequency components, but this is very inefficient in terms computational effort.) Hereby, the variance on the individual spectral estimate is reduced, but at the ‘expense’ of frequency resolution. Using the above given expression for the variance dependency on number of subtimeseries, it can be seen that using e.g. 30 subtimeseries reduces the variance on the individual spectral estimate to 18.3%, which for most purposes can be considered acceptable.

Due to the need for division of the timeseries into several subtimeseries (windowing), together with the assumption of periodicity of the signal, there will be a need for tapering of the signal within each end of the subtimeseries (which will force the subtimeseries for start and end at the same value). Failing to apply tapering will generally give raise to high frequency noise in the spectra. When apply tapering the tapered parts of the signal will be given less ‘importance’ compared to the non-tapered parts. Therefore, overlapping of the subtimeseries should be applied, so that the tapering up of the next subtimeseries is started at the same time step as the tapering down is initiated for the previous on.

The needed accuracy of the spectral estimates depends on for what the spectra is to be used. Often the characteristic parameters derived from the spectra are based on spectral moments of n^{th} order. The higher order moments the higher sensitivity to the accuracy of the individual spectral estimates. Thus, calculation of the spectral estimate of the significant wave height (H_{m0}), which is based on the 0^{th} (zeroth) moment (which is actually just the variance of the signal), is insensitive to the uncertainty of the individual spectral estimates. On the other hand, if looking at parameters based on higher order moments, such

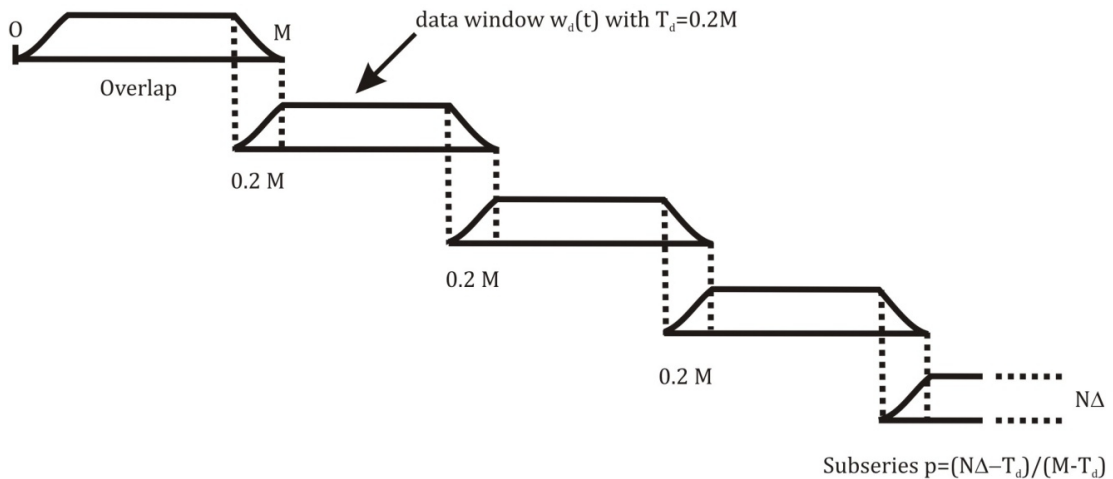

Figure II.A.5: Illustration of windowing, tapering and overlapping.

as spectral width parameters, or identification of peak frequencies (and thereby periods), definition of transfer functions etc. a larger accuracy is needed. This is ultimately going to define the needed duration of each test.

Time domain analysis

When performing a time domain analysis of a discrete signal, no assumptions have been made on the shape or characteristics of the signal. The needed sample frequency will therefore in this case be significantly higher than what is derived from the Nyquist frequency based on the frequency domain analysis. In order to obtain a reasonable description of a waveform signal (including water surface waves), a resolution of at least 20 data points per wave is needed. For other signals, the demand can be higher, e.g. monitoring of impulse pressure loads etc. Failing to use sufficiently high sample frequency will mean failing to identifying the ‘real’ crests and troughs of the acquired signal.

When performing a time domain analysis of a discrete signal, no assumptions have been made on the shape or characteristics of the signal. The needed sample frequency will therefore in this case be significantly higher than what is derived from the Nyquist frequency based on the frequency domain analysis. In order to obtain a reasonable description of a waveform signal (including water surface waves), a resolution of at least 20 data points per wave is needed. For other signals, the demand can be higher, e.g. monitoring of impulse pressure loads etc. Failing to use sufficiently high sample frequency will mean failing to identifying the ‘real’ crests and troughs of the acquired signal.

Assessing Minimum Quality and Quantity of Data

Using the definitions of Expanded and Standard uncertainty, we can write the confidence limits of the sample mean as:

$$\begin{array}{ll}
 90\% & \text{mean} \pm u_c \\
 95\% & \text{mean} \pm u_c \\
 99\% & \text{mean} \pm u_c
 \end{array} \tag{II.A.7}$$

Because the standard uncertainty can be related to the number of samples, it is possible to define the number of samples which are required to achieve a particular confidence interval. Based on results generated during the test programme, or from prior experience, it is possible to determine the total number of samples which are required to achieve a particular confidence interval. Defining the interval over which the confidence limits hold:

$$\begin{array}{ll}
 90\% & u_c = \text{Interval} / 1.64 \\
 95\% & u_c = \text{Interval} / 1.96 \\
 99\% & u_c = \text{Interval} / 2.58
 \end{array} \tag{II.A.8}$$

the value of u_c can be calculated and used along with the sample standard deviation to estimate the required sample size:

$$n = \left(\frac{s}{u_c} \right)^2 \tag{II.A.9}$$

In the situation where the data can be analysed as it is collected, or where the deviation in conditions between runs is known to be very small (for example in flume facilities), then the required quantity of data is that which would yield a statistical stationary dataset. Suggested methods of analysing the stationarity of a time series are:

- Comparison of the mean of the first half of the data with the second half;
- Autoregression on the running mean (to observe the running mean at instant k and compare it with that at $k - 1$. If the difference is less than some arbitrary ε then say the mean has converged.)

An example of this would be data collected from a flume via an ADV (acoustic Doppler velocimeter) probe over a period of a few minutes, sampled at 50Hz.

Figure II.A.6 illustrates a slow forward run in a towing tank. In this case the tank was heavily seeded with backscattering material in order to improve measurement quality from the acoustic probe. Only the section of the trace where the towing carriage is up to speed is shown. Sample mean is 0.4606 ms^{-1} . Mean values for the first and second half of the trace are 0.4595 ms^{-1} and 0.4617 ms^{-1} respectively. Thus the corresponding errors from the sample mean are approximately 2.3% in both cases.

It is demonstrated that the steadiness of the carriage forward towing velocity was acceptable. In this case a further 9 runs were acquired and compared. Only the first run was deemed unacceptable, the most likely explanation was that it was the first towed run of that day. Therefore it is essential that all data sets are continuously assessed during testing.

In a similar manner rotor torque and thrust was measured at the hub of a horizontal axis tidal turbine. The turbine was advanced at a constant speed with varying blade tip speeds between sets of towed runs.

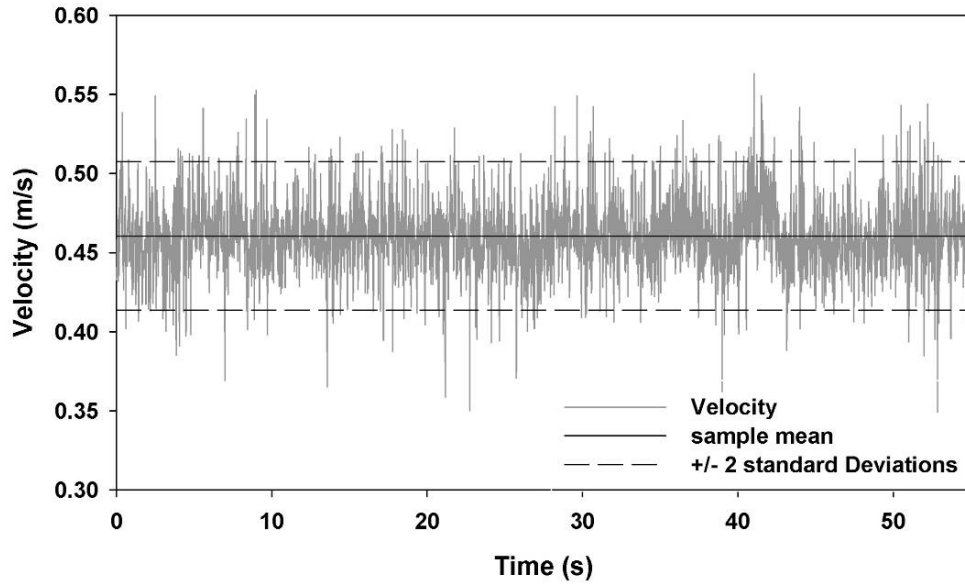

Figure II.A.6: Velocity measurement in a towing tank facility

Table II.A.1: Summary of example results

Run #	Measured mean Thrust (N)	Sample standard deviation (N)	Standard deviation between 3 data sets
RPM1	176.71	0.012	0.85
	176.75	0.011	
	175.26	0.017	
RPM2	148.23	0.010	1.04
	149.85	0.010	
	147.91	0.010	

Table II.A.1 illustrates the low variability of each run. For each separate run the sample variation was very low. Inter-sample standard deviation was slightly greater indicating that greater variation arising from this aspect of the testing. However, it was still well within limits which in this case were that the thrust measurement should be described within the interval $\pm 5\%$ with 95% confidence. Thus the stability of the performance facilitated a low number of towed runs (in this case 3) in order to accurately quantify performance at each set operational point.

It should be noted that in some cases variability was close to or exceeded 5%. In such cases data was collected until the variability fell within the set limits. Reasons for this could include increased unsteadiness due to high motion velocities on the hydrodynamic subsystem or resonance effects.

In cases where there is periodicity or other time dependency in the observed quantities - examples could be wave tank measurements or measurements on a tidal turbine rotor operating in yaw - then one of the following methods may be assumed in order to qualitatively determine whether sufficient data have been gathered:

- If the observed data are a function of an underlying signal which is known to repeat, then phase locking can be used and the averages of numerous cycles can be taken.

It is up to the experimenter to decide if it is appropriate to describe each cycle as an individual test.

- e.g. oscillating hydrofoil lift and drag histories phase locked with hydrofoil pitch and plunge oscillations.
- If the observed data are a function of a non-repeating signal synthesized, drawn or expected to be drawn from a specified or expected distribution where all bins of the distribution are expected to be represented an integer number of times, then frequency domain analysis, spectral moments should be calculated from zero to order 2, where convergence to 5% should be expected as per statistically stationary signal requirements for time series data.
- If the observed data are a function of a non-repeating signal synthesized, drawn or expected to be drawn from a specified or expected distribution as a truly random drawing, where the number incidences of a representation of a particular bin is either zero or a not necessarily integer multiple, then windowing should be applied to the signal and spectral moments should be calculated from zero to order 2, where convergence to 5% should be expected as per statistically stationary signal requirements for time series data.

II.A.3 Design of Experiment

The primary purpose of Design of Experiment in the context of EquiMar is the assurance that results generated from experimental tests have been derived in such a manner that the described response is satisfactorily linked to the explanatory variable(s). In other words, what is stated as having occurred due to an input *did* actually occur due to that input in a cause-and-effect relationship. This applies even if the precise physical mechanism is not fully understood.

Invoking the classic metaphor, this purpose is achieved in DoE by reducing the “signal to noise” ratio of the experiments, where the signal is the idealised measurement output and the noise is the corruption of this by nuisance factors. This is done by enhancing the signal and reducing the noise. Signal enhancing designs work by ensuring that the causality relationships are made as prominent as possible, and are built upon drawing these relationships out through the programme schedule (e.g. **factorial designs** and **Taguchi designs**). Noise reducing designs diminish the impact of extraneous nuisance factors by using insight into the sources of variability (e.g. **randomised** and **blocking designs**). In practise both signal enhancing and noise reducing designs are combined.

This document does not seek to outline all, nor necessarily the define optimal designs of experiment for a given situation. In general, the designs below assume a high level of factor orthogonally in the response and also (factor) linearity in the model. In situations where this is not the case or where certain combinations of factors are prohibitively expensive or hard to measure then more advanced methods such as Optimal Designs should be used. Descriptions of these can be found in NIST/SEMATECH e-Handbook of Statistical Methods and also in standard textbooks on statistics.

II.A.3.1 Choice of an Experimental Design

Based on the objectives of the test as described in Section II.A.1.1 the following proposed experimental designs are suggested for all except *Proof of Concept* type objectives, where

Table II.A.2: Appropriate Design of Experiments methods by purpose and number of factors.

	<i>Number of Factors</i>			
	1	2 - 4	5 - 50	>50
Comparison	Randomised	Randomised & Blocking	Randomised & Blocking	Randomised & Blocking
Screening	N/A	Full Factorial or Taguchi	Taguchi	Random Design
Response Surface Modelling	N/A	Full Factorial or Taguchi	Screen to reduce factors	Screen to reduce factors
Model Fitting	Randomised	N/A	N/A	N/A

the test will proceed in an ad-hoc manner:

The choice of the DoE methodology is therefore related to the objectives of the test and the number of factors under consideration. As it is uncommon that *purely physical* experimental tests for marine renewable energy device performance evaluation have very large numbers of factors, the Random design is most useful in combined computational/physical studies or when there are large numbers of control system parameters which can be changed as required.

II.A.3.2 Description of Experimental Designs

The following are some elementary DoE methods. The list is by no means exhaustive but these designs have been outlined since they have proven effective in R&D. Even though these designs are proven to be robust, they are not supposed to replace common sense or experience.

Randomised Design

Rationale: By randomising the order in which a series of tests are performed rather than performing them sequentially, such that as parameter values are altered the value of the factor is assigned at random from the pre-determined test conditions, errors introduced due to drift in the measurement apparatus will not be masked by trends due to altering the input parameter. If drift errors are introduced into the results and masked by a trend, they are impossible to remove. If the test sequence is randomised, analysis such as a **run order plot of residuals** will provide indication of the presence of drift. In practice, all experimental designs should include an element of randomisation for this purpose.

Process: Each case in the test series should be assigned a run-order number drawn at random from e.g. a table of random numbers, a random number generator or a hat.

Example: *choosing the order of angles of attack when performing a lift/drag test on a hydrofoil section at random will allow identification of possible drift in the tunnel speed due to the facility's motor temperature increasing over the course of the test. The test matrix is then of the form:*

Table II.A.3: Randomised Design of Experiment Test Matrix

α [°]	11	4	3	8	7	6	9	3	2	1	10
Run Order	1	2	3	4	5	6	7	8	9	10	11

Blocking Design

Rationale: In cases where there are factors which are not of primary interest under the objectives of the test, but must be included as they have been identified as having significant, albeit secondary, effects on the experimental outcome, these nuisance factors can be accounted for by using them as blocking factors.

The nuisance factors can take on values which are:

- **continuous**, e.g. daily trends in outdoor air temperature or barometric pressure. For example the outdoor air temperature and pressure might be important in determining cavitation and free surface effects during a marine turbine test.
- **piecewise continuous**, e.g. day of the week or time of day. For example the first run on Monday morning may not be performed optimally, and similarly runs before lunch or the final runs on Friday afternoon may be performed with undue haste.
- **discontinuous**, e.g. due to facility/equipment or operator. For example facilities and equipment differ in capability, even when calibrated, in terms of the quantity, type and quality of measurements available. Operators might read scales slightly differently, or have a predilection or bias towards certain parameter values (e.g. determining how long it takes for a towing tank to settle).

The basic rule of research methods applies here: reduce or randomise variation in nuisance factors as far as is possible, manipulate through blocking what is difficult or expensive to control.

Accounting for these requires that homogeneous blocks of test runs are made in which nuisance factors are held constant, but in which the primary variable(s) can be allowed to change according to a randomised design internal to the block. Blocking allows analysis of the results to account for the effects of the most important nuisance factors while the internal randomised design accounts for the less important variables.

Process: Blocks within the test programme are established (in an externally randomised manner) in which the blocking factor value is held constant. The blocking process requires every level of a primary, non-nuisance factor to occur the same number of times for each level of the blocking factors. Inside each block the variables of interest are allowed to vary according to an internal randomisation.

Example: Consider the hydrofoil in the example in II.A.3.2. Due to the level of uncertainty, 3 repeat test runs are required, and the test programme is scheduled over an extended period of time such that three different operators are employed in the tunnel tests. In this example the nuisance factors are the operators. The test runs are then performed allocated to operators in chunks as follows (colour coded per operator):

Table II.A.4: Blocking Design of Experiment Test Matrix

	Operator 1	Operator 2	Operator 3
α [°]	Randomised $0 \leq \alpha$	Randomised $0 \leq \alpha \leq 10$	Randomised $0 \leq \alpha \leq 10$
Run Order	1,2,3,4,5,6,7,8,9,10	1,2,3,4,5,6,7,8,9,10	1,2,3,4,5,6,7,8,9,10

Table II.A.5: Full Factorial Design of Experiment Test Matrix

Pitch \ ID	Blade Type A			Blade Type B			Blade Type C		
	θ_1	θ_2	θ_3	θ_1	θ_2	θ_3	θ_1	θ_2	θ_3
λ_1	1	2	3	19	20	21	37	38	39
λ_2	4	5	6	22	23	24	40	41	42
λ_3	7	8	9	25	26	27	43	44	45
λ_4	10	11	12	28	29	30	46	47	48
λ_5	13	14	15	31	32	33	49	50	51
λ_6	16	17	18	34	35	36	52	53	54

Full Factorial

Full factorial designs test all possible combinations of variables and as such are the most robust. It is assumed that every variable contributes significantly and all pairwise interactions are strong and important. The problem is that as the number of factors or the number of levels of these factors increases, the number of permutations increases very quickly: 4 factors at 3 levels equates to $3^4 = 81$ tests; 2 factors at 12 levels is $12^2 = 144$ tests etc. As such, in most situations a full factorial design may be prohibitively time consuming to perform, especially if multiple runs at each test condition are desired. If this is the case, Fractional Factorial methods such as the Taguchi method for orthogonal arrays should be considered.

Process: All combinations of factors and levels are listed and then performed in a random manner.

Example: A turbine test designed to test 3 blade types each at 3 pitch settings and 6 tip speed ratios would require 54 tests, which may be at the boundary of what is feasible. The test matrix in Table II.A.5 illustrates this process.

The run order is made up of a random drawing of test ID numbers. Obviously there is a pragmatic balance between optimal randomness and time taken to alter each factor value, and in this case the blade type would appear a good blocking variable.

Fractional Factorial

In the example of Section II.A.3.2, the total number of tests might become prohibitively large, especially when each test must be performed a number of times. The **Taguchi method** for orthogonal arrays allows a subset of the tests to be performed, under a number of assumptions, and still yields the important results. Taguchi methods assume few interactions between variables and only draws out pairwise interactions. It also assumes only

a few variables contribute significantly, thus helps identify large effects more significantly. Also, the number of factor values is assumed to be low: for example two level designs have only “high” and “low” factor values, whereas three level designs also have a “centre” or “medium”. Arrays can be found for higher numbers of parameter values.

Process: In the circumstance where the experimenter does not need to know how everything affects everything else it is expedient to not test all combinations but instead test ‘edges’ by finding pairwise combinations. In creating the test matrix every (most) 2 way combination of variables should be represented across all experiments. A table of experimental conditions, known as an orthogonal array, is determined based on the known number of factors and also the number of values each factor assumes. Tables are named “L#” where the number replacing the hash is the number of experiments which must be performed. For example, if there are 4 parameters each with 2 levels, a L9 table is appropriate (indicating that 9 tests will be required). If each parameter can assume 5 values, a L25 tables is required. There exist numerous tables of Taguchi designs - small ones can be made by hand, larger ones can be constructed using statistical analysis software or found online. L9 = 4 factors each of 3 states.

Random Design

Random designs can be near optimal, however they do not tend to work well on small experiments (< 50 factors) but work well for large systems. Random design assumes few interactions between variables and pulls out only a random sample of combinations, thus assumes very few of the many variables contribute significantly to the output.

Process: The process is very simple: choose number of experiments to run and assign to each variable a state based on a uniform sample of the variable values.

II.A.3.3 Replication and Choice of Factor Values

Given the implications of the Uncertainty Analysis, that is a diminishing uncertainty with increasing number of measurements, it behoves the test programme to allow some amount of repetition in measurements. Even if large quantities of time series data are collected at an experimentally stationary point, it is possible that unnoticed errors (especially operator/human error) render the reported value of that series incorrect, even though the reported uncertainty in the measurement is within the required bounds. To this end, it is advantageous to allow additional time in the test programme, not only for repetition of tests, but to determine the source of and correct for any disparity in results.

A suggested minimum number of repetitions is three. If the first and second tests do not match, then a third will be required by default. Where sample tests have been performed, it will be possible to calculate the number of data required by the method in Section II.A.4.6.

The ITTC Procedure 7.5-02-01-01 [9] makes the following definitions about repeatability and reproducibility of experimental results. For results to be considered repeatable the following conditions must be met:

1. The same measurement procedure is used using
2. the same instrument under the same environmental conditions in
3. the same facility over

4. a short time period, i.e. the same day.

If one or more are violated, then the results may be said to be reproducible at best.

II.A.4 Uncertainty Analysis (UA) and Data Quality Assurance Procedures

The uncertainty associated with a measurement can be described under one of three categories:

1. **Standard uncertainty** c is made up of Type A (statistical) and Type B (non-statistical) estimates and are expressed as:
 - **Type A** (see II.A.4.3): the standard deviation of the mean, equal to the standard deviation (positive square root of the variance) for a single test;
 - **Type B** (see II.A.4.4): as the approximation of the standard deviation, calculated from the approximate variance determined from an assumed probability distribution.
2. **Combined uncertainty** u_c brings the standard uncertainty of a number of measured variables together as, typically, an uncertainty in the expression of a derived quantity via the uncertainty of numerous factors propagated through data reduction equations.
3. **Expanded uncertainty** U qualifies the combined uncertainty by including a coverage factor k such that an interval defined about a reported measured value has a specific probability of containing the true value of the measurement.

The uncertainty is calculated as the root square sum of the contributing bias and precision uncertainty:

$$U^2 = B^2 + P^2 \quad (\text{II.A.10})$$

In estimating bias, B , it is generally simpler to estimate elemental contributions than it is to attempt to identify bias through single sets of experimental results (if it is possible at all). Calibration simplifies this and allows instruments which would have a large number of contributing elemental biases to be treated as a single bias.

In estimating precision, P , it is often more cost and time effective to analysis the precision errors en masse, that is as if propagated through the DREs to some extent, rather than on an individual basis, and as such this protocol follows ITTC 7.5-02-01-01 [9] and recommends direct computation of the precision of the final result.

The approaches used to estimate standard uncertainty differ depending on whether the observations are consistent with a single test with multiple samples at a fixed test condition, or whether they are from multiple independent tests.

Single tests are those where the test duration is relatively instantaneous by comparison with the timescales associated with any of the experimental variables. In this situation the test can be assumed statistically stationary and the measurement of any variables over the relatively short duration of the test is considered a single test, even if the number of readings used to generate the mean is (significantly) greater than one.

Examples of measurements from single tests are those associated with single tow tank runs where a large number of samples are taken once the carriage is at the desired velocity.

Multiple tests are those which are performed in order to attempt to extend the test duration so as to capture sufficient variation of experimental factors. This is done by repeating the test over sufficient time periods to capture any long-period variation, or where multiple subsamples are taken from a single test run in order to capture any variation which is on a timescale of less than the test duration.

Examples of measurements from multiple tests are those associated with the means of the values measured during individual tow tank runs.

II.A.4.1 Methodology

The overall Uncertainty Analysis methodology can be split into pre-test and post-test phases as follows: Pre-test

1. Write down Data Reduction Equations (DREs) and draw a data flow block diagram.

Outputs:

- a list of measurement systems and variables.

2. Perform a sensitivity analysis to determine where best to focus efforts.

Outputs:

- a table listing the sensitivity coefficients for terms in the DREs;
- Partial derivatives of terms appearing in the DREs.

3. Estimate the bias and precision limits using information from the sensitivity study and any available Type A or B sources.

4. Modify and improve the test setup and programme so as to reduce estimated uncertainty below the required level.

At this point the test should be carried out. During the test it is up to the developer and facility operator to determine at which point sufficient data has been collected. Ideally, if the test progresses well according to the plan, then sufficient data will be collected if all the tests required by the Design of Experiment are performed, for example if during runs the standard deviations are sufficiently small and the tests are highly repeatable. However, it may be necessary to perform additional tests in order to reduce the uncertainty, and it is expedient to budget time for these from the outset.

Once the experimental data are collected, the following Post-test UA may proceed:

5. Perform a visual inspection of the data, identifying outliers, unexpected correlation, drift, autoregression etc., using the Data Quality Assurance methods of Section II.A.4.7;
6. Calculate the results of the experiment via the DREs, and apply any correction factors;
7. Determine the combined uncertainty for all factors in the experiment propagating uncertainties using the root sum square (RSS) methods of Section II.A.4.2
8. Express the uncertainty as an expanded uncertainty, with a coverage factor, the size of the uncertainty and state the level of confidence.

II.A.4.2 Propagation of Uncertainty

Once precision *or* bias² uncertainty components have been evaluated, by Type A and/or B means, the combined standard uncertainty is evaluated by using the **law of propagation of uncertainty**. Given a system modelled using a DRE of the form

$$y = f(x_1, x_2, x_3, \dots, x_N) \quad (\text{II.A.11})$$

where f is a functional relationship describing some performance parameter based on measured quantities x_i in such a manner that any known covariance is captured in the equation. The combined standard uncertainty of y is linearised by considering the first 2 terms (but the constant is discarded) of a Taylor expansion of f :

$$\begin{aligned} u_c^2(y) &= \sum_{i=1}^n \sum_{j=1}^n \frac{\partial f}{\partial x_i} \frac{\partial f}{\partial x_j} u(x_i, x_j) \\ &\equiv \sum_{i=1}^n \left(\frac{\partial f}{\partial x_i} \right)^2 u^2(x_i) + 2 \sum_{\substack{i=1 \\ i \neq j}}^n \sum_{\substack{j=1 \\ j \neq i}}^n \frac{\partial f}{\partial x_i} \frac{\partial f}{\partial x_j} u(x_i, x_j) \end{aligned} \quad (\text{II.A.12})$$

The partial derivatives are the sensitivity coefficients, used when performing a sensitivity analysis (see II.A.4.5 below) and can be evaluated analytically or numerically. The terms $u(x_i, x_j)$ are the estimated covariance and $u(x_i)$ is the estimated uncertainty. These values are determined using the methods below.

Monte-Carlo Simulation

Some situations might arise whereby a numerical rather than analytical (as above) approach may be undertaken. This might be because it is impractical to evaluate the propagation of uncertainties analytically or where it is desired to validate analytical results. In these situations, the Monte-Carlo Simulation (MCS) sampling methodology should be applied to the DRE. A basic MCS methodology is as follows:

1. Given a variable represented by a DRE of the form $y = f(x_1, x_2, x_3, \dots, x_N)$, generate N samples for each of the measured variables x_i , randomly drawn from assumed or known (possibly joint) distributions, e.g. normal, triangular or rectangular, around a nominal operating point.
2. For $k = 1$ to N , evaluate the DRE to yield y_k
3. Calculate sample standard deviation for the N results y_k and hence $u(y)$
4. Confidence intervals may be found by sorting the list of y_k into ascending order and determining the required upper and lower percentiles.

The quality of MCS results is dependent on the number N of samples: a number between 10,000 and 100,000 is suggested, and given the low computing overhead, entirely feasible. The MCS method has the advantage that it can produce an output distribution which can be compared to experimental results. In addition, due to the nature of the method, limits will be constrained to physical (according to the DRE) values.

²Bias and precision uncertainty contributions should be calculated by independent root-square-sums

II.A.4.3 Standard Uncertainty - Type A UA

A Type A uncertainty analysis is one based on valid statistical method(s) applied to the data. In particular, precision components of uncertainty, P , are evaluated based on the number and scatter of measurements. The uncertainty associated with a Type A UA is simply represented by the estimated standard deviation, as given by equation II.A.2 in Section II.A.2.

Type A analysis can also calculate bias, literally the difference between the mean of a series of measurements and the expected mean.

II.A.4.4 Standard Uncertainty - Type B UA

A Type B Uncertainty Analysis is one that is NOT based on statistical methods applied to the data. Type B Uncertainty Analysis relies on experience and judgement, and is thus more subjective than a Type A UA, and is reliant on assimilation and consideration of all relevant information, such as:

- Previous experience, either mathematical or physical, with the specific test subject;
- Previous experience or familiarity with the test procedure, facility, instrumentation etc.;
- Knowledge of existing test data including use of data from different facilities;
- Specifications and data provided by facility, instrument or test piece manufacturer;
- Calibration and specifications/certification requirements data;
- Any other data source, e.g. textbooks, handbooks, rules-of-thumb.

There are a number of means of performing a Type B evaluation, the most common being where uncertainty is evaluated based on reported values from an outside source, e.g. quoted by an instrument manufacturer, or determined by calibration of the facility. These are generally supplied either as a multiplier of standard deviation or a confidence interval.

Other means of obtaining a Type B uncertainty are by considering the data as being from an assumed distribution. Examples of this are shown in Table II.A.6.

II.A.4.5 Sensitivity Analysis and Estimation of Bias Limits

Bias limits are the bounds of the bias component, B , of experimental uncertainty, and the magnitude can be estimated and included in the uncertainty statement, and in the expanded uncertainty via a root square sum. Bias limits are defined by the bound that the magnitude of the true value of experimental bias is expected to be less than, 95% of the time.

The methods and calculations used to perform a Sensitivity Analysis can be recycled to estimate the bias limits.

The process for evaluating a linearised approximation is as follows:

1. Write down the DRE in the form $y = f(x_1, x_2, x_3, \dots, x_N)$ where f is a functional relationship describing some performance parameter based on measured quantities $x_1, x_2, x_3, \dots, x_N$ in such a manner that any known correlations are captured in the equation.

Table II.A.6: Uncertainty Estimates from Assumed Distributions

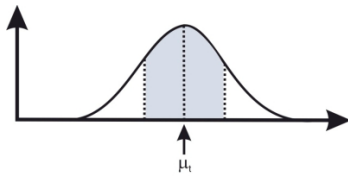
**Normal Distribution**

Define a fractional region of the PDF such that the odds of the true value lying in the interval $\mu \pm a$ are

- “50-50” then $u \cong 1.48a$ (i.e. $a \cong u/1.48 = s/1.48$)
- “2 times in 3” then $u \cong a$
- “99.73%” then $u \cong a/3$

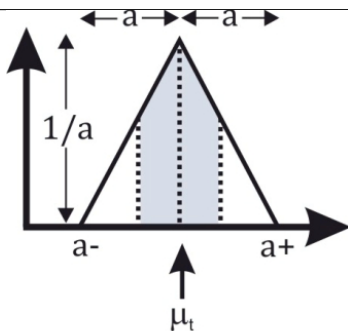
**Triangular Distribution**

If the true value is 100% contained within interval $\mu \pm a$ but there is a central tendency, then

- $u = a/\sqrt{6}$ where a is the **half-width** of the interval

Triangular is more conservative than normal.

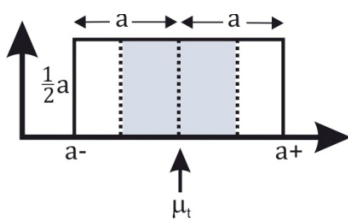

Rectangular Distribution If the true value is 100% contained and equally likely to fall (uniformly distributed or distribution not known at all) anywhere in the interval $\mu \pm a$ then

- $u = a/\sqrt{3}$ where a is the **half-width** of the interval

Applications are resolution uncertainty of digital displays and generating random numbers. Often used with information from calibration certificates/specifications. The GUM [4] suggests that this is used as the “worst case” distribution if the actual distribution of the data is not known, as the rectangular distribution is more conservative than both triangular and normal.

- Write down the total derivative of the function f with respect to some variable, then divide through by the differential:

$$df = \frac{\partial f}{\partial x_1} dx_1 + \frac{\partial f}{\partial x_2} dx_2 + \frac{\partial f}{\partial x_3} dx_3 + \dots \frac{\partial f}{\partial x_N} dx_N \quad (\text{II.A.13})$$

At this point it may be convenient to use a direct calculation of the deviation due to small perturbations equal to tolerances as determined by Type B analysis, evaluated about a nominal operating condition, to yield the bias limits. If so, go to step 4, otherwise perform step 3.

- Calculate an approximation for the by substituting in the finite differences $\Delta x_{1\dots n}$ then dividing through by the original expression f gives the expression for the fractional changes in Y due to small changes in $x_1, x_2, x_3, \dots x_N$:

$$\frac{\Delta f}{f} = \frac{1}{f} \sum_{i=1}^N \left(\frac{\partial f}{\partial x_i} \Delta x_i \right) \quad (\text{II.A.14})$$

- At this stage nominal values (estimates or predictions of anticipated test conditions) should be tabulated, along with the estimated bounds, attained via tolerances associated with a Type B UA on the nominal values. Checks should be performed to ascertain how symmetric or otherwise the individual bias limits are, and it is suggested that if bias limits are asymmetric, then the limit with the maximum effect on the DRE should be used.
- Once the coefficients have been calculated, a root-square sum of the form **of the law of propagation of uncertainty** provides the bias limits for y . Again, if the bias limits for y are found to be asymmetric, then it is the maximum bias which should be quoted and used in equation II.A.14.

As an example, consider a proposed test on a model tidal turbine which will use the current through a resistor to measure turbine power. This gives rise to the following DRE for the power coefficient:

$$C_P = \frac{2I^2 R}{\rho U^3 \pi r^2} \quad (\text{II.A.15})$$

Following steps 2 and 3 above, taking the necessary derivatives gives

$$\begin{aligned} \Delta C_P &= \frac{\partial C_P}{\partial I} \Delta I + \frac{\partial C_P}{\partial R} \Delta R + \frac{\partial C_P}{\partial \rho} \Delta \rho + \frac{\partial C_P}{\partial U} \Delta U + \frac{\partial C_P}{\partial r} \Delta r \\ &= \frac{4IR}{\rho U^3 \pi r^2} \Delta I + \frac{2I}{\rho U^3 \pi r^2} \Delta R - \frac{2I^2 R}{\rho U^3 \pi r^2} \Delta \rho - \frac{6I^2 R}{\rho U^3 \pi r^2} \Delta U - \frac{4I^2 R}{\rho U^3 \pi r^2} \Delta r \end{aligned} \quad (\text{II.A.16})$$

Which when divided through by the original expression (equation II.A.15) gives the following simple form of the fractional difference in power coefficient:

$$\frac{\Delta C_P}{C_P} = \frac{2\Delta I}{I} + \frac{\Delta R}{R} - \frac{\Delta \rho}{\rho} - \frac{3\Delta U}{U} - \frac{2\Delta r}{r} \quad (\text{II.A.17})$$

Table II.A.7: Sensitivity Analysis for a Tidal Turbine

		Nominal	Bounds	Source	Coefficient	$\Delta C_P / C_P$	ΔC_P	%
I	A	0.63	$\pm 9.45 \times 10^{-4}$	Voltmeter documentation ($\pm 0.015\%$)	1.5×10^{-3}	3×10^{-4}	1.2×10^{-4}	< 1
R	Ω	1000	± 50	Gold band tolerance ($\pm 5\%$)	0.05	0.05	0.02	5
ρ	kgm^{-3}	998.2	± 0.04464	ITTC	4.5×10^{-5}	4.5×10^{-5}	1.8×10^{-4}	< 1
U	ms^{-1}	1.0	± 0.01	Calibration documentation ($\pm 1\%$)	0.01	0.03	0.012	3
r	m	0.8	± 0.0001	CNC machine tolerance ($\pm 0.01\text{mm}$)	1.25^{-4}	2.5×10^{-4}	1×10^{-4}	< 1
C_P	[1]	0.4	± 0.023	Root Square Sum	-	0.058	0.023	5.8

Based on nominal values, the following table can be created using data from various Type B analyses:

By examining these results, it is apparent that maximum benefit in this case will be achieved by focussing effort on resistor tolerance and inflow (carriage) velocity measurement. The bias limits for C_P are 5.8%, and the assumption here is that they are symmetric.

II.A.4.6 Estimating Precision Limits

Precision limits are the bounds of the precision component, P , of experimental uncertainty, and the magnitude can be estimated and included in the uncertainty statement and the expanded uncertainty via a root square sum (RSS). Since precision errors present themselves as the scatter, due to random errors, of measurements around some biased mean, the precision limits give the interval in which the (biased) results are expected to fall 95% of the time under repeatability conditions.

The ITTC Procedure 7.5-02-03-01 suggests using a series of 5 sets of tests each with 3 speed measurements where the model is removed and reinstalled between each set of measurements as a means of determining the precision limits from the standard deviation. It is suggested that this is a suitable means of including random errors such as misalignment etc.

The precision limits for a measured variable obtained from a series of experimental tests with n observations are simply the experimental standard deviation of the mean, equation II.A.4, multiplied by the coverage factor, k , and can be written as:

$$P(x) = k \frac{s(x)}{\sqrt{n}} \quad (\text{II.A.18})$$

The value of k is determined from Student's t-distribution, using t-tables and is assumed to be equal to $\cong 2$ (as per the GUM [3], NIST guidelines [4] and ITTC 7.5-02-01-01 [9]) for large sample sets where n tends to infinity (in practise $n > 30$) for a 2-tailed t-distribution

and 95% confidence. This equation assumes a normal distribution and that the central limit theorem applies. For further information, consult the GUM.

Single Test with a Single Sample

The worst case scenario is precision limits for single tests with a single sample. These are impossible to estimate using this method since k is not defined for zero degrees of freedom. This might arise, for example, in the case where a single measured value for swept area is used to calculate turbine performance using time series data from a towing tank, or when time series data are from such a small interval that factor variation is not adequately represented at all. In this case a methodology similar to that applied to estimate bias limits (Section II.A.4.5) is used to estimate the first order Taylor expansion:

$$P(x_i) = \sqrt{\sum_{j=1}^J \left(\frac{\partial x_j}{\partial x_i} \cdot P(x_j) \right)^2} \quad (\text{II.A.19})$$

This now becomes a Type B uncertainty analysis, with estimates for the precision limits of measured variables coming from sources on the list in II.A.4.4, e.g. instrument precision error.

In single tests where some or all measured variables are available as averages over the test period, then precision limits in equation II.A.19 from the subsample approach to the multiple test analysis should be considered, if the test period is sufficiently long.

Multiple Tests

With multiple tests (where s is determined using the pooling formula equation II.A.5) or multiple subsamples from a single long (relative to factor variation) test, the number of observations n scales as the number of tests. n is thus greater than 1 and the experimental standard deviation of the mean and hence the precision limits of the estimated value decrease with the inverse square of the number of measurements. Thus to reduce precision limits by half (i.e. halving the uncertainty in the absence of any uncertainty contributions due to bias), four times the number of tests are required. In order to reduce the precision limits to $1/10^{\text{th}}$ their original value, 100 times the number of tests are required. This clearly has the potential to be extremely expensive, and as such it is up to the developer and facility to determine the cost compromise between additional tests and upgrading the experimental process or instrumentation.

Standard Forms Table

Table II.A.8 lists the combined uncertainty for some standard DRE forms and lists the RSS in terms of coefficients $\partial x_i / \partial x_j$ where the terms u are synonymous with the uncertainty in the subscripted factor. The approximations are exact if there is no correlation.

II.A.4.7 Data Quality Assurance Procedures

Once measurement data are obtained as a time series of values from an instrument, before a detailed analysis is undertaken it is good practice to perform a quality check to ensure the experiment is proceeding as anticipated. Graphical methods, for example the 4-Plot

Table II.A.8: Combined Uncertainty for some Standard Forms of DRE

Addition/Subtraction

$$f(x_1, x_2, x_3, \dots, x_n) = \sum_i^n x_i$$

$$u_c^2(f) = \sum_i^n u_{x_i}^2 \approx u_{x_1}^2 + u_{x_2}^2 + \dots + u_{x_n}^2$$

Multiplication/Division

$$f(x_1, x_2, x_3, \dots, x_n) = \prod_i^n x_i^{p_i}$$

$$\left[\frac{u_c(f)}{f} \right]^2 = \sum_i^n p_i \frac{u_{x_i}}{x_i} \cdot \sum_j^n p_j \frac{u_{x_j}}{x_j} \approx \sum_i^n \left[p_i \frac{u_{x_i}}{x_i} \right]^2$$

Reynolds Number

$$\text{Re} = f(\rho, V, l, \mu) = \frac{\rho V l}{\mu}$$

$$\begin{aligned} \left[\frac{u_c(\text{Re})}{\text{Re}} \right]^2 &= \frac{(u_\rho)^2}{\rho^2} + \frac{(u_V)^2}{V^2} + \frac{(u_l)^2}{l^2} + \frac{(u_\mu)^2}{\mu^2} + \\ &\left(\frac{2u_V u_\rho}{V\rho} - \frac{2u_V u_\mu}{V\mu} - \frac{2u_\mu u_\rho}{\mu\rho} + \frac{2u_l u_\rho}{l\rho} + \frac{2u_l u_V}{lV} - \frac{2u_l u_\mu}{l\mu} \right) \\ &\approx \frac{(u_\rho)^2}{\rho^2} + \frac{(u_V)^2}{V^2} + \frac{(u_l)^2}{l^2} + \frac{(u_\mu)^2}{\mu^2} \end{aligned}$$

Froude Number

$$\text{Fr} = f(V, g, l) = \frac{V}{\sqrt{gl}}$$

$$\begin{aligned} \left[\frac{u_c \text{Fr}}{\text{Fr}} \right]^2 &= \frac{u_g^2}{4g^2} + \frac{u_V^2}{V^2} + \frac{u_l^2}{4l^2} + \left(\frac{u_g u_l}{2gl} - \frac{u_g u_V}{gV} - \frac{u_l u_V}{lV} \right) \\ &\approx \frac{u_g^2}{4g^2} + \frac{u_V^2}{V^2} + \frac{u_l^2}{4l^2} \end{aligned}$$

espoused by in the NIST eHandbook [7], provide quick and easy checks on data quality. The 4-Plot consists of plotting:

1. Run order plot

Plotting i vs. y_i provides an early visual indication of:

- Data randomness or variation - vertical spread;
- Underlying trends or drift - “flatness” and apparent gradients;
- Possible outliers.

2. Lag plot

Plotting y_{i-n} vs. y_i determines if an observation is related to an observation n previous:

- Indication as to whether there is an underlying function and;
- Indication of underlying function form.
- If there is an underlying form, indication of outliers.

3. Distribution histogram

Plotting y vs. *counts* will provide:

- Indication of data mean (the centre) and spread and skew;
- Indication of outliers;
- Indication of what sort of (possibly multimodal) distribution the data follow.

4. Normal probability plot

Plotting a normal distribution of theoretical values for ordered y vs. ordered y values aids in:

- Determining if the data are normally distributed and thus if the normal distribution is a good model for the data;
- If the distribution has fat tails, long tails or skew;

The plots shown in Figure II.A.7 are all basic data analysis methods, and as such guidance on interpretation may be sought from any standard data analysis or statistics textbook, or online at, e.g. the NIST eHandbook. They should be considered the minimum requirement in analysis a time series of data. Further analysis proceeds with analysis of variance, correlations and frequency characteristics.

II.A.4.8 Correlation

Scatter diagrams where the value of one factor is plotted against the value of another can be used to qualitatively demonstrate whether there is any correlation between the data. Since the methods and the DREs in Table II.A.8 simplify somewhat if the correlation between factors can be neglected (in other words there is no or very little joint variation between factors allowing various of the terms $\partial x_i / \partial x_j$ to be ignored) it is suggested that as a minimum a matrix of scatter diagrams be used to ascertain whether further statistical evaluation of the correlation is required.

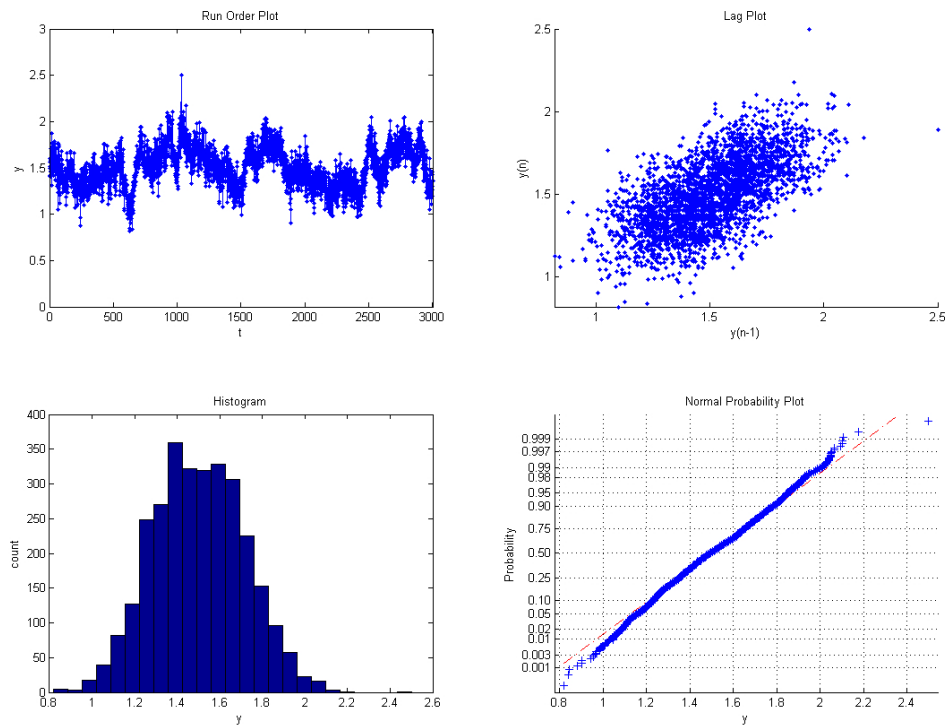

Figure II.A.7: The 4-Plot for a data series.

The following image (Figure II.A.8) illustrates the process. The matrix is symmetric (in the diagonal) and the results are plotted in the lower region and the correlation coefficient is shown in the top region. The diagonal shows a correlation coefficient of 1, since the results are plotted against each other. Correlation coefficients magnitude shows the strength of the pairwise correlation, with the plot corresponding to 0.96 demonstrating high correlation thus the $\partial x_i / \partial x_j$ cannot be neglected, whereas the low correlation (0.3) would allow $\partial x_i / \partial x_j$ to be justifiably ignored.

II.A.4.9 Outliers

Outliers are data that have been recorded which fall outwith the expected range of values. They can be incorporated within experimental results by means of hardware glitches or errors, which can produce impulses, spikes or short time constant responses, which in general saturate the measurement system. Examples of this are poor electrical connections and electromagnetic interference or instantaneous loads associated with slamming waves or slippage in a mechanical fixing.

Outliers can also exist due to inaccuracies in the assumption of the expected data distribution. For example, a distribution can have “fat”-tails by comparison with the normal distribution, and therefore it is an error in expectation rather than in measurement. It is important to properly inspect outliers to determine if they are a member of the underlying population distribution, which may differ from that expected, or a member of some other population.

Noise can also present itself as outliers. In this situation it is suggested that the source of the noise be identified and remediated rather than excessive smoothing/filtering be applied.

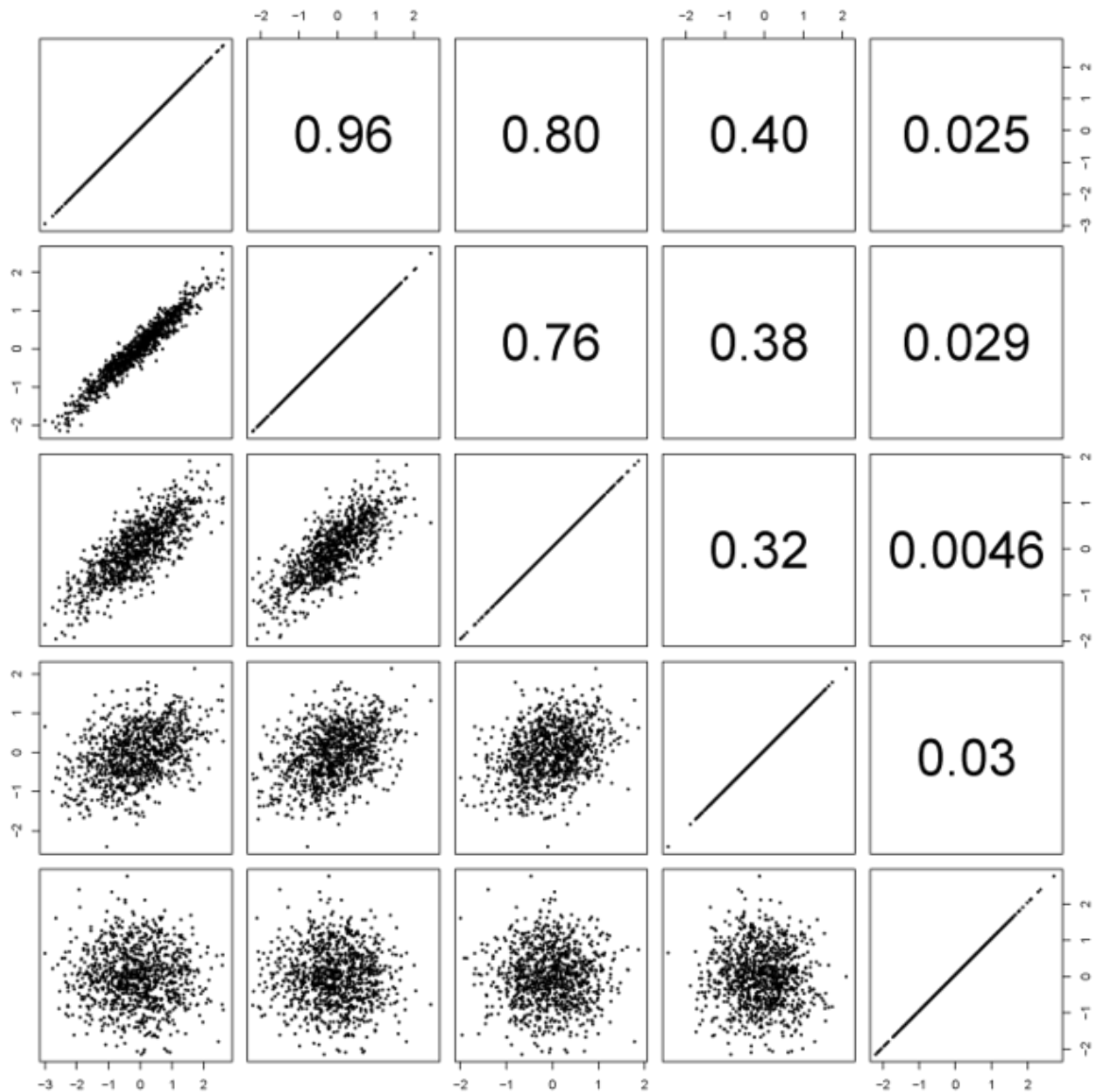

Figure II.A.8: Linear Correlation Example. Taken from Wikimedia.

This will reduce the possibility of noise masking outliers due to unexpected fat-tailed distributions. Remediation can be accomplished by the systematic removal of experimental apparatus until the source is identified.

Identification

The standard methods for identification of outliers are:

- Visual inspection and rule of thumb;
- Students t-Test;
- Chauvenets criteria;
- Grubbs test.

These methods are well established and simple to apply, and are also facilitated in standard data analysis packages. Care should be exercised when removing data: the source of the outliers should be sought and an explanation for their presence and justification of their removal offered when reporting.

II.A.5 Calibration [Of Sensors]

Calibration is the process by which systematic errors leading to bias uncertainty are identified and removed from measurement equipment. Once equipment has been calibrated, there is always bound to be a random error associated with using the equipment to make a measurement, and the random error of a calibrated instrument is as likely to be positive as negative.

II.A.5.1 Force

Static Following ITTC Procedure 7.5-01-03-01 [12], section 5, force calibrations on e.g. load cells or strain gauges are generally performed under static conditions, in the dry using traceable masses. The relation between force F , gravitational acceleration g and mass m is then given by

$$F = m.g \left(1 - \frac{\rho_a}{\rho_w} \right)$$

Where the term in parenthesis is a buoyancy correction. The reference masses have been calibrated at a traceable laboratory. If force multipliers (levers) are used, then appropriate terms should be incorporated into this relationship. The reference loads are then compared against the indicated loads and the characteristic equation of the instrument can be determined.

Dynamic No guidance on calibration for dynamic loads is given in this protocol, excepting the requirement for sample rate.

II.A.5.2 Air Temperature, Density, Pressure and Viscosity

Temperature Thermometers must have a traceable calibration route to a recognised calibration laboratory. If using a thermocouple, the calibration must be carried out against a calibrated glass thermometer.

Density Air density follows from the perfect gas equation of state if temperature and pressure are known via: ***TODO*** no equation in Word file!

Pressure Air pressure is obtained via local airfields or weather reports from news stations or their websites. Local laboratory measurement requires a traceable barometer, adjusted correctly for altitude.

II.A.5.3 Speed and Velocimetry

Fluid Velocity Portable electronic velocimetry equipment, specifically ADV (acoustic Doppler velocimeters), suitable for use in water is generally sealed and factory calibrated, therefore no calibration is possible.

Calibration of Pitot probes, as defined in ISO 3966:2008 [13] must allow for wall effects, unsteady flow or velocity gradients and turbulence, the effects of temperature and particle entrainment and the flow direction. The water density must be also known with the appropriate level of accuracy.

Tow Carriage Velocity Tow-tank facility velocities are calibrated via a number of internal cross-checks:

- a trailing wheel with a magnetic or optical sensor;
- optical or magnetic sensors on components of the drive system;
- optical or proximity sensors at known displacements along the rail;
- carriage mounted immersed pitot static probe (gives relative fluid point velocity);
- laser displacement measurements against fixed points.

Accuracy of tow-tank velocities is generally very good, and a survey by the ITTC [14] found that in for all respondents tow-tank speed measurement accuracy is below 0.1% of the maximum speed. The majority of respondents also report calibrating their facility once or twice per year.

Blockage For flumes and towing tanks, the inflow or carriage velocity can be used to provide the incident velocity to the data-reduction equations for thrust and power, however, in doing so a conceptual bias error will be introduced. This is due to the possibility of there being velocity gradients across the power capture area caused by the presence of the device itself, known as blockage. Correction for this follows from either a non-intrusive (optical) measurement with the device in situ, or if this is impractical via blockage correction factors for example that of Barnsley-Wellicombe [15] as modified and applied by Bahaj et al [16].

II.A.6 Experiments on Extreme or Rarely Occurring Events

Testing of the device performance in extreme conditions is a desired requirement in ensuring performance as a vessel - i.e. ensuring safe station keeping, seaworthiness, survivability and validating failure modes. Results will be required by investors, insurers and engineers considering underwriting development, deployment and operation and produced through due-diligence investigations, undertaken by commissioned third parties. For wave devices, station keeping data while operating in various sea states must be generated: combinations of wave height, grouping, steepness should be examined based on theoretical considerations (identified sensitivities to slamming loads, overtopping/shipping of green-water, capsize/stability, etc.). Tidal energy converters require examination in various flow speeds and directions (as well as wake and turbulence levels if possible) beyond the design envelope. Tidal devices may also require an examination of wave/structure interactions if the technology will be significantly affected by waves.

Survival tests are therefore an essential requirement before progression to Stage 3. This document provides qualitative guidance and recommendations only and does not seek to provide guidance on what constitutes an extreme condition as these are highly site and device specific in terms of which particular combination of conditions produce the worst loading conditions.

II.A.6.1 Rarely Occurring Wave Conditions

Deterministic analysis of the effects of various extreme wave events requires the synthesis of wavefields with one or more extraordinarily high waves in an otherwise ordinary regular or irregular sea. In general, numerical results and Stage 1 experiments performed in a small tank will produce conditions which must be examined at Stage 2 to test sea keeping in specific, pre-determined wavefields. Metocean conditions corresponding to the proposed deployment site should be used if available with extreme conditions calculated as per Deliverable 2.2.

II.A.6.2 Rarely Occurring Tidal Conditions

Tidal devices at Stage 2 should be tested in a facility capable of generating fluid velocities greater than the appropriately scaled velocities of proposed test sites; large scale, high intensity turbulence should also be added and where possible wakes induced into the flow. It is appreciated that the scaling of turbulence is problematic and it is not entirely clear as to how this can be done in a rigorous manner - therefore this is an option that will provide qualitative behaviour only. Turbulence kinetic energy spectra generated should be broadly similar to the Batchelor spectrum (measured via LDV etc.) or a site specific spectrum if available.

II.A.6.3 Scale Recommendation

In performing tests of extreme conditions there is generally a major issue that a scale prototype will have been scaled for power performance measurements in seastates which are readily and manageably produced by a particular test facility. It is therefore unlikely that the same facility will be able to produce the large waves or currents required to adequately test the prototype at that scale. This being the case, it is recommended that as a developer moves from Stage 1 to Stage 2 testing, which will involve moving from a facility which can produce appropriate conditions for 1:50 testing to one which can facilitate 1:10 testing, that the small-scale prototype be reused in the large-scale facility.

II.A.6.4 Reporting

The reporting of tests in extreme conditions will be as per other tests, however any device failures, or observations of abnormal performance or behaviour will be noted and explained along with a brief description of whether the failure was due to erroneous scaling used for model sizing or the design being tested (i.e. relative to full scale).

II.A.6.5 Required Measurements

The following are a minimal list of the types of measurement for a generic device: some will not be applicable in a particular case.

Stability and Trim

For a device which floats e.g. many wave devices, or is acting as a vessel e.g. under tow during deployment, the metacentric height, device trim and water level(s) are of critical importance in determining stability. These data are used in verifying computer simulations of extreme operating modes.

Accelerations

Acceleration measurements are required alongside stability and trim data as inputs for the validation of computational predictions of device behaviour in various failure, survival and operational modes. Accelerometers and inclinometers should be placed carefully such that correct transformation can be made between the local and global coordinate systems via e.g. an Euler transform.

Displacements and Attitudes

Generally, device free-response should be measured using an appropriate system incorporating measurements in as many degrees of freedom as possible. For devices on the surface, optical systems can be incorporated using infra-red reflectors to determine the device motion. If the device is submerged alternative approaches must be sought, e.g. inclinometer or accelerometer traces.

It is also often desirable to test the device while restricted in some axis, for example in testing longitudinal or lateral stability in the absence of heave motion. Such tests require that the device be secured in such a manner that only the motion of interest is permitted, and therefore it is essential that the displacements and attitudes of the device are measured correctly before, during (if possible) and after the test.

Overtopping Volume and Frequency

In devices where overtopping is a possible or actual operating mode, wave probe measurements of overtopping height, or flow-meter measurements of discharge should be sought.

Impact Loads and Vibration

Slamming is accompanied by a very rapid spike in local pressure at the slamming location which peaks and falls very quickly. Therefore, in order to adequately measure this phenomena sample rates must be very high. Further complications are that the sensors themselves have resonant frequencies and as such special care must be paid in selecting appropriate transducers. Further guidance is provided in ITTC 7.5-02-07-02.3 [18]. Device natural vibration frequencies are also likely to be very high for stiff metal structures, and measurements must thus be taken at appropriate sampling rates.

System Dynamics

For devices composed of numerous interconnected reacting subsystems, e.g. pitching blades on a rotating hub, then the device dynamics must be recorded. This includes displacements, if any, from trim or operating points, any actuator loads, control system inputs etc. It is especially important to identify actuators which become rate-limited in non-standard operational modes, since any scaling of the control system implemented under the assumption that these actuators are performing fully will result in problems. Early identification is the key. Operational modes simulating the effects of failed actuators or PTO should be performed, e.g. tests of infinite or zero damping for wave devices, or with runaway or stopped rotor for tidal turbines.

Waves

The EMEC Wave Tank Testing Standard [19] suggests the following wave conditions:

- For seakeeping tests high energy as well as short period, steep waves (approaching the breaking limit). A suggested minimum scaled time series of a 3 hour storm is advised (bearing in mind the recommendations of Section II.A.2.2 A H_{m0}/H_{max} ratio of 1:1.8 - 1:2 is required).
- For extreme loading the device characteristics need to be determined over a range of seastates and appropriate extreme conditions based on these must be modelled. It is suggested that wave periods close to device resonance periods will produce maximum loads.
- For extreme motions of the device, wave frequencies according to some or many of the device natural frequencies as well as breaking waves should be tested.

II.A.7 Qualities of Prototype Models

Ideally, a prototype model would be dynamically scaled against the full scale device. However, limitations in the ability to dynamically scale all components, coupled to the cost of ensuring that all components are built to exacting tolerances lead to the following pragmatic guidance.

It is essential that the hydrodynamic subsystem is scaled appropriately, either by kinematic or dynamic means. Other subsystems can be substituted, simulated or removed, depending on the nature of the test and scale of the model. In general, best practice is to ensure that components other than the hydrodynamic subsystem do not hamper the operation of the hydrodynamic subsystem in unrealistic ways, but other than that no requirements on build quality are made. Therefore, once the components are fabricated, they can be measured, and the protocol requires the following geometric tolerances, after ITTC Procedure 7.5-01-01-01 [20] and ITTC Procedure 7.5-01-02-02 [21]:

- $\pm 1\text{mm}$ or $\pm 0.05\%$ for hull, reaction subsystem etc. components
- $\pm 0.1\text{mm}$ for rotor diameter, thickness and chord
- $\pm 0.5\%$ for pitch at each rotor radius

II.A.7.1 Power Take Off

At Stage 1, in order that the effects of power take-off (PTO) systems on hydrodynamic performance are adequately represented it is likely that the scale PTO be significantly different from both Stage 2 and prototype scale PTO systems. This is due to significant disparity in the scaling laws for power and geometry. The situation is often further complicated by non-transparent boundaries between hydrodynamic and PTO subsystems, and PTO and control subsystems.

At early stages, concept appraisal tests will not necessarily have a complete power conversion chain: i.e. the PTO may be simulated by mechanical or viscous means. If a complete PTO is present, then there will almost certainly be no attempt at connecting this into the electrical distribution network, power may simply be dissipated into a controlled load, or some other mechanism may be employed. There will be losses associated with

every stage of the power conversion process. The number of links in the power chain may be large, depending on the complexity of the PTO process being adopted:

Incident hydrodynamic to

- Aero/hydrodynamic motion (conversion)
- Mechanical (conversion)
- Viscous [damper/orifice plate] (power dissipation)
- Head (energy storage)

Mechanical to

- Viscous [damper] (power dissipation)
- Electrical (conversion)
- Mechanical motion [linear \Leftrightarrow rotational, direction/sign change] (power conversion)
- Mechanical storage [spring, mass elevation] (energy storage)

Electrical to

- Heat [resistor] (power dissipation)
- Electrical [DC \Leftrightarrow AC] (power conversion)
- Electrical [DC \Rightarrow sink device] (power dissipation)
- Electrical storage [capacitance] (energy storage)

In general, the flow of energy will be uni-directional as the scale of losses decreases the further down the PTO process.

At each conversion, in addition to losses, there will generally be a change in the time response shape of the power signal. In other words, at each conversion there will be a relationship between the input power signal and the modified output power signal carrier. This relationship will, in general, be non-linear and potentially difficult to model mathematically. As such, for the purposes of Stage 1 & 2 tests (proof of concept and controlled preliminary power performance evaluation) it is critical that performance measurements used to characterise device power performance (rather than whole system performance) must be taken at the notional hydrodynamic subsystem/PTO interface. This can be defined as the point where the hydrodynamic power conversion takes place. In some cases this might not be obvious or measurements at this point may be impractical. Therefore, the best compromise between a meaningful and sensible power indicator, intrusion into the operation of the device and the requirements of fabricating and instrumentation of the test prototype should be sought.

II.A.8 Archival and Storage of Data

Data will be generated during the experimental tests in a number of formats, however it is anticipated that standard analysis packages will be present in most facilities. As such, it is likely that data will be recorded in file-types associated with those packages.

```

LabVIEW Measurement
Writer_Version 0.92
Reader_Version 1
Separator Tab
Multi_Headings No
X_Columns No
Time_Pref Absolute
Operator luke
Date 10/06/2010
Time 57:26.6
***End_of_Header***

Channels 4
Samples 100 100 100 100
Date 10/06/2010 10/06/2010 10/06/2010 10/06/2010
Time 57:27.5 57:27.5 57:27.5 57:27.5
Y_Unit_Label Volts Volts Volts Volts
X_Dimension Time Time Time Time
X0 0.00E+00 0.00E+00 0.00E+00 0.00E+00
Delta_X 0.01 0.01 0.01 0.01
***End_of_Header***
X_Value Thrust Torque Thrust (N) Torque (Nm) Comment
-0.003687 -0.003687 -1.691090481 -0.065322579 10/06/2010 09:57:26\09
-0.024714 -0.0211 -11.33539738 -0.3738287
-0.003359 -0.004016 -1.540649017 -0.071151477

```

Figure II.A.9: Example metadata from a LabVIEW file.

Occasions where this may not be the case are when data is dumped directly from the instrument onto some internal or external media (for example certain acoustic Doppler velocimetry devices, and also custom/bespoke experimental setups).

Data will be recorded in either binary (computer readable) or ASCII/UTF plain text (human readable) and the requirements for good practice in data storage are similar.

ASCII/UTF: The advantages of human readable formats is that the information contained within is available and (given sufficient metadata) usable without the creating software. “Off-the-shelf” human readable files can be created in formats such as comma/tab-separated values (filename.csv) which can be read and produced by most software, including Excel, LabVIEW and MATLAB.

Binary: The advantages of binary formats is a speed advantage in computer input/output and also that they can often contain the same information as a human readable file, but occupy significantly less storage space. Binary formats are essentially closed unless sufficient information is given in the metadata and as such are generally locked to the software that created them. For this reason **human readable data storage formats are to be preferred**.

Metadata are lines of human readable information containing data such as the date, time, operator, equipment type and direct measurement scale (e.g. mV) and converted scale (e.g. kg). Metadata appear as a header in both binary and human readable files. Optimally, metadata should also be included as a footer, whereby missing or corrupt footer metadata indicate file truncation.

An example of metadata from the header of a file is shown below:

As a suggested minimum requirement the following must be stored in the metadata:

- (Local) Time and Date stamp, minimally for the initiation of the test, optimally for each record;
- Facility, Test Process and Operator;
- Software used (e.g. LabVIEW, MATLAB) and computer architecture and OS (Intel x86, AMD64, PPC; Unix/Linux, MacOS, Windows...) especially important in binary files;

- Number of channels (streams), data sampling frequency and number of samples;
- Data type, for example integer (int8, int16...), float, double. This is also especially important in binary data files.
- If non-proprietary or in house software is being used to generate binary data files, metadata should include a field indicating the length of the metadata itself, in bytes, and also the “magic word” which is used to indicate the end of the metadata.

II.A.9 Documentation

It is recognised that in general research groups, companies and individuals will each have their own style, template or standard form of a report. The experimental results should be presented in a concise report whose structure can vary, where the following guidelines may be adopted to give a consistent feel or function as an aide-mémoire:

Executive Summary

- What the client wanted
- What was done to achieve the client objective
- What the most important results were.

Introduction

- What the client wanted and some background to the clients requirements,
- What information was available to the project team,
- What approach was agreed with the client,
- What tools were to be used,
- What key outcomes were expected from the work.

Analysis Method

- Facility information, including capabilities and limitations;
- Description of mathematical models;
- Description, diagrams and information on scaling of physical test pieces;
- Description of DREs and statistical analysis.
- Sources and characteristics of input/inflow conditions;
- Description and diagrams of process, measurement systems, data-stream in block-diagram;
- Outline of Sensitivity Analysis and Design of Experiment including test matrices;
- Detailed description of error sources considered and methods of Uncertainty Analysis;

- Description and rationale of tools, apparatus, equipment and procedures;
- Images that usefully illustrate important aspects of models, or other subjects of investigation. Avoid complex diagrams with illegible text or figures that are difficult to decipher.
- Relevant construction information
- Time periods simulated, monitored, etc.
- Rationale and description of any correction factors.

Results

- Results presented in a standard form for the device class (if it exists) as defined in sections ?? and ?? including the uncertainty expressed in the forms outlined in section ?? above. TODO find where these refs point!
- Presentation of main outcomes and discussion of the meaning of the results in the context of the client brief.

Conclusions

- To what extent the results of the project have met the client's needs.
- Any other significant findings that arose during the course of the project.
- Guidance to the client as to how the results should be used or interpreted.
- Recommendations for further work if appropriate.

Definitions:

Model: A mathematical approximation to the behaviour of the prototype. In general, a useful model may be a very simple series of algebraic expressions or an appropriate computational code (such as Blade Element Method) such that performance data may be quickly generated

Prototype: The device or component to be tested. This will be proportionately scaled down from full size, to an extent commensurate with the limitations of the test facility.

Deterministic: Of a process or system, one where future states are wholly determined by those preceding, i.e. in which there is no random variability. Mathematical models, computer simulations and theoretical calculations are generally completely deterministic (within the bounds of rounding errors and where random processes have not been artificially added).

Statistical: Of a process or system, one which includes random variation. Statistical methods are then used to extract the response of a system hidden in the data to 'noise' in the data; the major tenet is to locate and describe repeatable underlying phenomena. Repeated measurements yielding different results under fixed conditions are an indication that the process is statistical, although the reverse is *not necessarily true*.

Test: A process of measurements leading to some result.

Measurement: An indication of the state or a property of some object.

Confidence level: The level of certainty that the true value of a measurement lies within a particular margin.

Interval: The margin within which the true value of a measurement is said to exist.

Error: The difference between measured and true value of a thing being measured.

Uncertainty: The level of doubt in the measurement result.

RSS: Root-sum-of squares. The means by which uncertainty is propagated.

DRE: Data reduction equation.

References

- [1] *ITTC Quality Systems Manual Version 2008*.
- [2] “Assessment of Experimental Uncertainty with Application to Wind Tunnel Testing.” (S-071A-1999).
- [3] ISO/IEC, “Uncertainty of measurement – Part 3: Guide to the Expression of Uncertainty in Measurement,” *ISO*, 1995.
- [4] B. Taylor and C. Kuyatt, “NIST Technical Note 1297: guidelines for evaluating and expressing the uncertainty of NIST measurement results,” *National Institute for Standards and Technology*, 1994.
- [5] “The International Vocabulary of Metrology - Basic and General Concepts and Associated Terms (VIM),” *ISO, Geneva, Switzerland*, 2007.
- [6] NIST, “Reference on Constants, Units and Uncertainty,” December 2010.
- [7] NIST/SEMATECH, “e-Handbook of Statistical Methods,” December 2010.
- [8] “EquiMar Deliverable 3.3, Assessment of current practice for tank testing of small marine energy devices.”
- [9] “Guide to the Expression of Uncertainty in Experimental Hydrodynamics,” 1999. ITTC Procedure 7.5-02-01-01.
- [10] “Testing and Extrapolation Methods, General Uncertainty Analysis in EFD, Guidelines for Resistance Towing Tank Tests,” 1999. ITTC Procedure 7.5-02-01-02.
- [11] “Testing and Extrapolation Methods: Propulsion: Performance Propulsion Test,” 2002. ITTC Procedure 7.5-02-03-01.1.
- [12] “Uncertainty Analysis: Instrument Calibration.” ITTC Procedure 7.5-01-03-01.
- [13] “ISO 3966:2008 Measurement of fluid flow in closed conduits. Velocity area method using Pitot static tubes,” 2008.
- [14] ITTC, *Resistance Committee*, vol. 1, 2008.
- [15] M. Barnsley and J. Wellicome, “Final report on the 2nd phase of development and testing of a horizontal axis wind turbine test rig for the investigation of stall regulation aerodynamics. Carried out under ETSU Agreement E,” tech. rep., 5A/CON5103/1746, 1990.

- [16] W. Batten, A. Bahaj, A. Molland, and J. Chaplin, “Experimentally validated numerical method for the hydrodynamic design of horizontal axis tidal turbines,” *Ocean Engineering*, vol. 34, no. 7, pp. 1013–1020, 2007.
- [17] “EquiMar Deliverable 2.2, Draft Protocols on Physical Environment Specification.”
- [18] “Loads and Responses: Seakeeping: Experiments on Rarely Occurring Events,” 2002. ITTC Procedure 7.5-02-07-02.3.
- [19] “Marine Renewable Energy Guide: Tank Testing of Wave Energy Conversion Systems,” tech. rep., 2009.
- [20] “Model Manufacture: Ship Models,” 2002. ITTC Procedure 7.5-01-01-01.
- [21] “Model Manufacture: Propeller Models: Propeller Model Accuracy,” 2005. ITTC Procedure 7.5-01-02-02.

Chapter II.B

Field Trials

II.B.1 Introduction

II.B.1.1 A Five Stage Device Development Programme

The three EquiMar engineering protocols were designed in conjunction with the International Energy Agency's Implementing Agreement on Ocean Energy Systems (IA-OES) 5 Stage development programme for wave energy converters (WECS). The objective is to complement that overview document by detailing the project planning and technical requirements necessary to safely and successfully advance the design of a WEC with minimum risk and uncertainty. This protocol addresses Stages 3 and 4 and introduces guidelines for the testing, monitoring and evaluating of the sea trial of solo devices.

The US Department of Energy's (DOE) Technology Readiness Assessment scheme for the development of marine hydrokinetic (MHK) devices also follows a similar format but with 9 Technology Readiness Levels (TRL). These are combined into 5 funding sub-groups that can be cross related to the 5 Stage plan as shown in the figure II.B.1.

The devices performance monitoring, analysis and evaluation is designed in accordance with the IEC TC114; Marine Energy technical specification; Power Performance Assessment of Electricity Producing Wave Energy Converters.

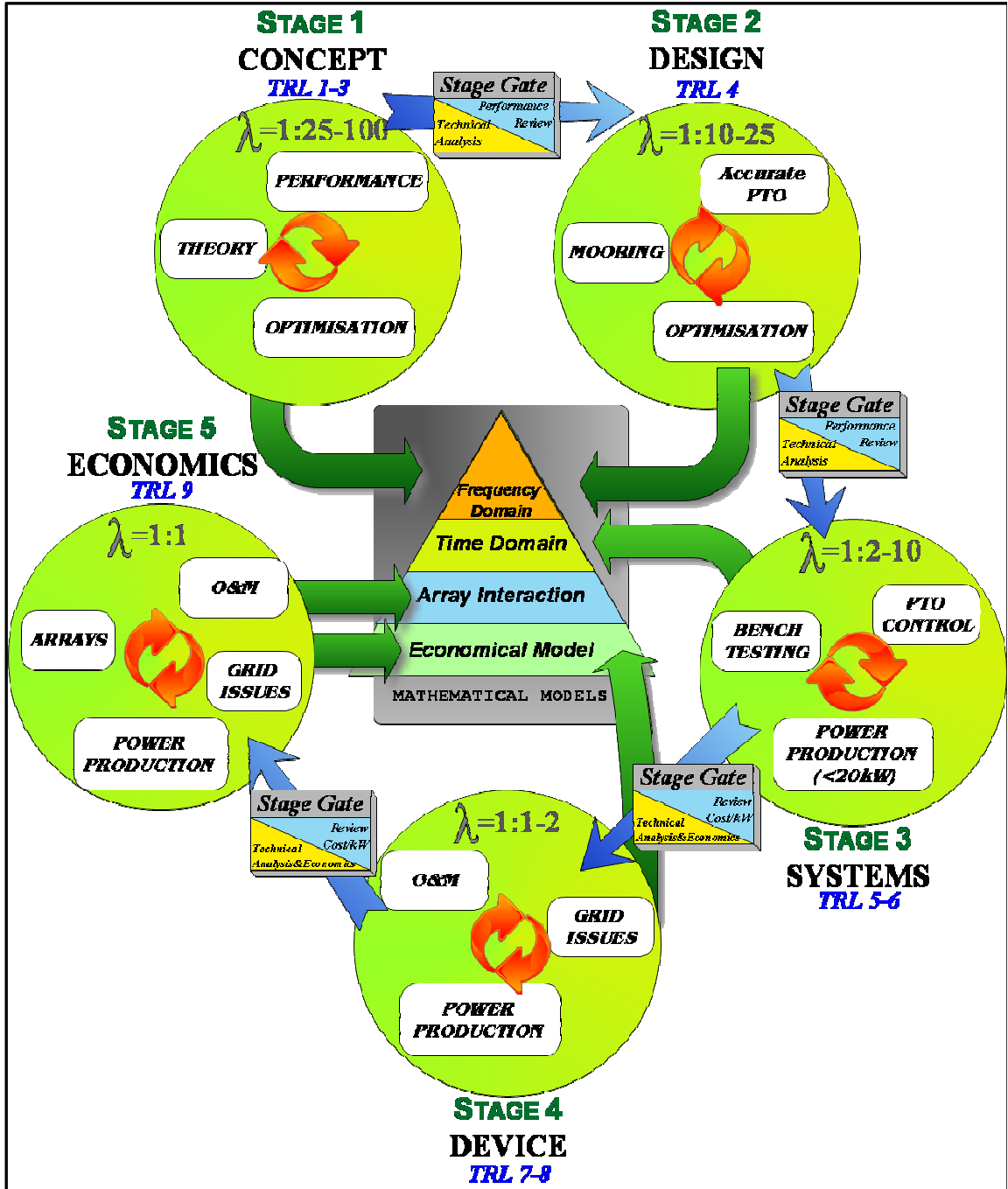

Figure II.B.1: The five stage development programme for marine energy converters

Chapter II.C

Deployment and Performance Assessment of Multi-Megawatt Device Arrays

II.C.1 The need for guidance

In the short to medium term wave and tidal energy devices will be installed in multiple numbers at a given site. Such installations are commonly known as farms or arrays. As with many other technologies it is expected that the scale of arrays will increase in time from a few MW initially to perhaps many hundreds of MW. A key driver for installation of an array of devices is to increase the production of energy whilst maintaining or decreasing the unit cost of energy when compared to a series of isolated devices. This is achieved with general economy of scale, the sharing of systems (such as electrical connections) and reduced installation/maintenance costs per device. As arrays become larger in size (in terms of number of devices and energy extracted) interaction effects between devices are expected to increase in magnitude and complexity. With limited research work having been completed to date regarding array performance and interaction effects the need for guidance is clear.

It is expected that progress in array development will increase rapidly in order to reduce the cost/installed power capacity ratio. Thus there is significant possibility that publications regarding array design and performance will quickly become outdated. At the time of writing there has been a reasonable body of research conducted regarding wave and tidal device interactions both experimentally and numerically. However the work has opened up a host of new research areas. As arrays are scheduled for the short-medium term research work in this area is accelerating rapidly. Therefore this element of the EquiMar project will provide qualitative recommendations where there is any element of doubt as to the absolute measurement of an aspect of array design or performance.

II.C.2 Pre-deployment

The following scales of array deployments are considered:

- Demonstrator arrays - up to 10 devices
- Small - 10-50 devices

- Medium arrays - 50-200 devices
- Large arrays - 200+ devices

Electrical arrangements (on and offshore), array layout and deployment issues all increase in complexity with each of these 4 stages.

II.C.3 Device classification

Reference: For more detailed discussion and description of the device classification please refer to deliverable 5.2

The need: to date attempts to classify wave and tidal energy devices have relied upon visual descriptions of the basic device form. A more detailed classification is required that not only accurately describes how they operate but also defines key aspects of device subsystems and device performance metrics.

Methods: This section of the protocol describes a process to classify wave and tidal energy conversion devices herein referred to as wave and tidal energy devices. The classification recommends a “layered” structure to describe various elements of a wave or tidal energy device.

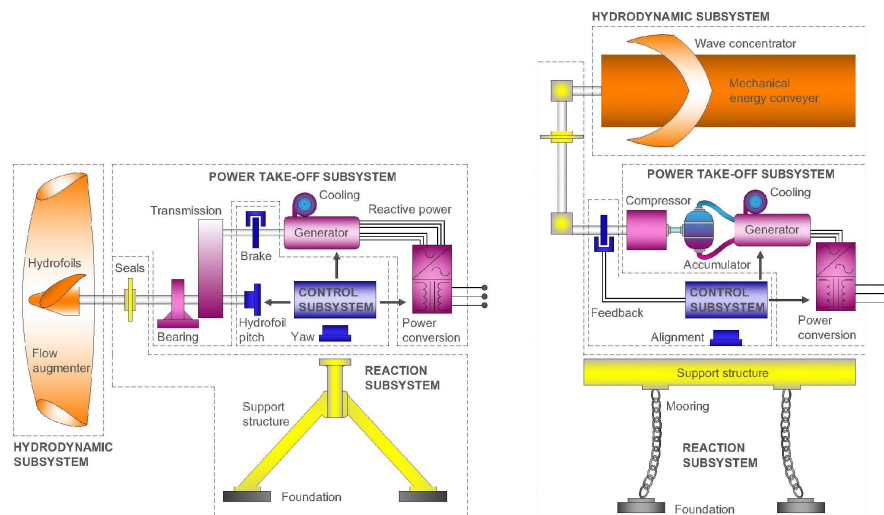

Figure II.C.1: Schematic subsystem diagram of tidal (left) and wave (right) energy devices

The top layer includes information that will allow the user to verify the basic form of the device providing information on the method of energy extraction, and the characterisation of the physical form and motion paths of the hydrodynamic subsystem. Layer 2 offers

information concerning the power take-off system, whilst layer 3 addresses how the device is kept in place in the marine environment and how key aspects of the device are controlled.

The classification characterises the device in a progressive and compartmented manner in order to provide a complete and logically flowing description. Wave and tidal energy devices have been divided into 4 discrete subsystems as per figure II.C.1. (Components shown within each subsystem are examples and not indicative of any particular device)

Both classification templates define the device by the way it captures energy; through the shape/trajectory of any component motion paths and the physical principals involved. In this manner devices that are similar in appearance can be differentiated. All 4 subsystems are defined using the classification and the output parameter such as electrical power is also specified. The classification is for use by all marine energy stakeholders and is of most use to those wishing to compare devices in an equitable manner. Details of device descriptors and instruction on how to use the classification templates can be found in deliverable 5.2.

II.C.3.1 Guidance for assessment of the marine energy supply chain

The marine energy supply chain is at an embryonic stage. Dedicated suppliers are not yet abundant due to the relatively small scale of the industry but suppliers in related applications may have the capacity to modify their existing products/services to supply the marine energy sector.

Present experience of the marine energy supply chain is that many major components such as gearboxes, blades, hydraulic generators etc. that would eventually be mass-produced are currently being manufactured as custom (on-off) units. Costs are therefore high with full design, development and custom tooling/fabrication often required. This increases costs and lead times for prototypes, both of which are likely to be reduced for arrays. Figure II.C.2 demonstrates an appropriate scenario for the continual development of the marine energy supply chain.

Above specific issues regarding technology components, planning etc. there are two fundamental aspects that are hindering the marine energy supply chain diversity of concepts, and lack of standards.

The diversity of concepts has prevented (or at least complicated) the development of series built components as different devices (which are almost all at present one-off prototypes) have very different requirements, meaning that suppliers are required to perform full checks and design reviews on every component produced.

Lack of standards is also hindering the development of series built products as suppliers cannot always use off-the-shelf equipment which may satisfy existing standards from other industries.

Supply chain weakness

As the marine energy industry expands the supply chain may not grow at the same rate in order that marine energy deployment in arrays is conducted in the most efficient manner. For supply chain stakeholders there are 2 potential strategies: The first is to be in position to supply goods or services in advance of demand. The second is to wait until demand for good/services is strong enough and move in to supply the industry. Both routes involve an element of risk for suppliers. It could be argued that the former is not realistic for early stages of the technology as the volumes of devices and deployments at the demonstrator array stage and even for small arrays is insufficient to allocate dedicated resources by

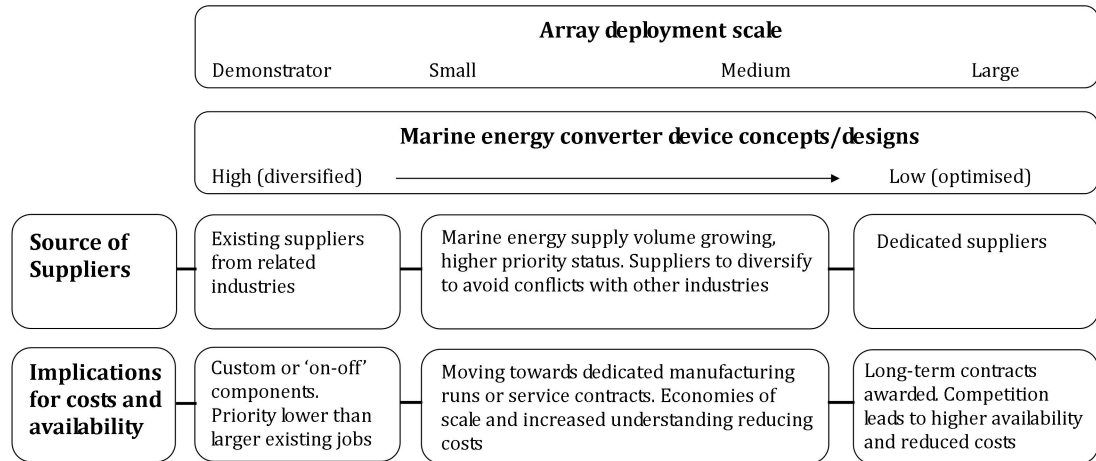

Figure II.C.2: Evolution of the marine energy supply chain

suppliers. Therefore there are likely to be incremental delays in array deployments but if appropriate steps are taken these can be minimised and reduced with the scale of array deployment. There are a number of lessons that can be learnt from the offshore wind industry which is perhaps the most closely related to wave and tidal energy involving renewable energy devices deployed offshore.

Key device bottlenecks/constraints for marine energy converters

Device developers must prove technology is robust:

- By logging appropriate operational hours at sea trials (see IIB of protocol) and at subsequent array deployment scales
- Demonstrating reliability of all device subsystems (key to O&M actions for arrays)
- As the size of arrays increases reduce the cost of energy

Financial institutions that wish to invest in the industry will no doubt have their own definitions of 'operational hours' but it is likely to be heavily based upon power production and not simply having a device deployed at site. The risks must be both certain (accurately quantified) and below appropriate thresholds before private investment is made.

Governmental support is also vital for an emerging industry. Mechanisms and levels of support vary throughout Europe and the industry has already seen device developers

move towards regions with the most generous funding. Capital expenditure support is attractive for developers who face high costs with early low-volume products. Rewards-based support such as electricity generation subsidies are perhaps more attractive to the awarding funding body as only successful devices will be able to benefit thus de-risking the industry and promoting strength.

Regulation and planning

Regulation might be a key bottleneck for the marine energy industry. IIC is not addressing marine spatial planning issues but stakeholders should acknowledge previous experience in related industries such as offshore wind energy. Regulation and planning requirements vary by country and sometime by region and this should be investigated as part of any pre-deployment action. Environmental issues are addressed in part IB of the protocol.

Land and marine-based actions

Deliverable 5.7 gives enhanced detail of specific actions that may cause disruption to the marine energy supply chain.

Land-based actions include: Manufacturing, transport (to shoreline), port infrastructure, and onshore electrical grid.

Marine-based actions include: Deployment vessels, array location metocean quantification, offshore electrical grid connection and operation & maintenance actions.

II.C.3.2 Guidance on determining appropriate electrical connections

Reference: For expanded guidance on aspects of electrical connections of arrays please refer to deliverable 5.1 and 5.4.

The need: up-scaling of wave and tidal energy will no doubt build upon knowledge from related applications such as wind energy and thus may occur at a faster rate. Guidance is therefore required at an early stage. Principal issues surrounding Connection configurations are detailed below. For expanded description and applicability to marine renewable energy see deliverable 5.1.

- I. Proximity to shore
- II. Device Mobility
- III. Seabed and cable landing conditions
- IV. Individual device size
- V. Physical Spread of devices within an array
- VI. Location of Connection point to the device
- VII. Accessibility
- VIII. Water depth
- IX. Proximity to strong grid system (transmission system)
- X. Smoothness of Electrical Power

- XI. Control of voltage and power factor (generator related)
- XII. Ability to remain connected during grid disturbance
- XIII. Power duration curve

Compliance with onshore electrical grid requirements

Array developers should be familiar with the Grid and Distribution Codes that apply to the country in which the array is connected. The codes require electricity suppliers to match their device to the point of common coupling. Issues such as frequency stability, voltage, power factor, harmonics and fault level all need to be taken into account.

Array developers should be aware that codes vary between countries and that transmission system operators have had to adapt their grid codes to enable large-scale wind farms to connect to the grid. Wind farms are no longer only considered as embedded generation but required to contribute to grid stabilisation and voltage and frequency control. Wave and tidal energy will benefit from this experience as they share common features with wind energy.

The requirements imposed by grid codes are generally dependant upon the policy set for each country. The growing interconnection between different national grids and the increased generation from wind energy have highlighted the need for a standard base for grid connection common to all the European countries.

A report from the European Wind Energy Association [1] delivered in 2005 summarises the principal issues related to the connection to the grid of large wind farms. Table 2.1 in deliverable 5.1 shows a list of basic requirements imposed by national codes for wind energy. Such requirements have not yet been defined for marine energy because of the negligible impact of wave and tidal energy production on global electrical power supply but those defined for wind energy are likely to be applicable to future large scale marine energy plants.

Tables 2.2 and 2.3 of deliverable 5.1 summarise existing transmission and distribution codes for several European countries. Grid connected power generating marine energy devices will be required to comply with these regulations.

Technical issues for connection to the grid

Large scale marine energy farms installed to maximize energy output will probably have major limitations in terms of:

1. Voltage and reactive power control
2. Frequency control
3. Fault ride-through capabilities

These are the three main points that new grid codes are adapting for wind farm connection.

1. Future marine energy farms should have the capability to control the voltage and/or the reactive power at the connection point. Several methods for voltage control have been adopted in wind energy technologies (deliverable 5.1) and might be considered for application to marine energy.

2. Existing grid codes require wind farms to participate in frequency control of the network through variation of the active power output. However, as for wind turbines, wave and tidal converters are not able to provide the same control guaranteed by conventional power plants. Array developers should be mindful that modifications of national grid codes may occur as it has been happening in the last years for wind energy.
3. When a short circuit takes place in some location on the grid, the voltage on the faulted phases will be zero. Due to the low impedance of transmission circuits a large voltage depression would be experienced across large areas on the transmission system until the fault is cleared by the opening of circuit-breakers.

Older grid codes required the disconnection of wind turbines during such faults but, with the increasing relevance of wind power production, these regulations had to be changed since the contemporary disconnection of many generators within the system would cause an additional loss to the one determined by the fault and could determine a frequency drop and even a black-out.

For these reasons nowadays in many countries (Denmark, Ireland, Spain) with a relevant penetration of wind power into the grid, wind farms are required to have a fault ride-through capability for faults on the transmission system. Typical requirements for this case are described in deliverable 5.1. (Fig. 2.4 and 2.5).

Section 3.3 of Deliverable 5.1 offers guidance on typical AC connections from array to grid for early generation and established arrays.

Section 3.4 of Deliverable 5.1 offers guidance on typical DC connections from array to grid. As this type of electrical system is suited to significant power transmission over long distances it is acknowledged that offshore wind energy will most likely reach this stage before wave and tidal energy. Therefore observations of the effectiveness of this electrical system can be observed in advance of its application to very large and remote wave and tidal arrays.

Clustering within large arrays

The number of devices connected in one circuit within an array is limited as electrical barriers exist as a result of both the capacity of the collection cables and the voltage drop along their length. The maximum number of devices per circuit is therefore a function of the generators rated capacity and the adequate spacing between the different units of the farm. Therefore, generating units are expected to be grouped into medium-voltage electrical collection subsystems within the marine farm. Those arrangements, so-called clusters, are then integrated together via offshore platforms from where the transmission to shore is initiated.

The number of clusters somehow determines the number of devices per cluster as the total installed power of the system is usually fixed. Different numbers of clusters cause different network topologies and, thus, result in different costs, power losses and reliability.

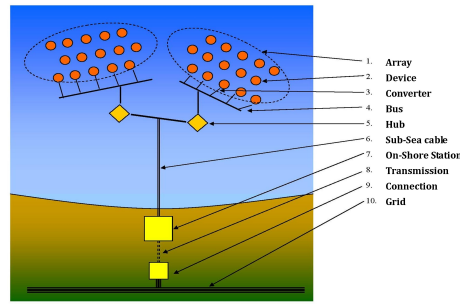

Array	Define rated power and annual energy yield	Quantify distance to shore	PLC and remote control (SCADA)
Device	Device type: require bi-directional power flow?	Choose device rated power and voltage level	Safety equipment
Power converter	AC/DC converter: type? (PWM, almost invariably)	Electrical connector (required if the device has to be disconnected for maintenance)	Full, partly or not hosted on board
Bus	AC or DC bus, depending on what converter is hosted on the device or on monopole above the water		
Hub	May host bus-DC/AC converter (choose converter technology) or AC/DC, or AC/DC/AC	Transformer	
Sub-sea cable	Voltage rating depending on farm size/	DC or AC?	
On-shore station	Protection (circuit breakers and switchgear)	Flywheel and doubly-fed machine to smooth farm power output?	Capacitor banks/ power factor Correction. Transformer?
Connection	Required?	transmission	transformer protection
Grid	Distribution or transmission line?	Standards and agreement with grid operator	

Figure II.C.3: Scheme of the elements of a marine energy farm connection interface. TODO - figures not very legible

Concept	Scheme a	Scheme b	Scheme c	Scheme d
Advantages	Very high availability, low losses	Very low installation cost, simple maintenance	High availability	Low installation cost
Disadvantages	High installation costs, connections onshore necessary	Low availability, may imply high losses	Connections onshore necessary	Difficult to find faults, complex system
Possible installation	Very small farms close to	Small farms with low risk	Large farms with high risk	Large farms with low risk

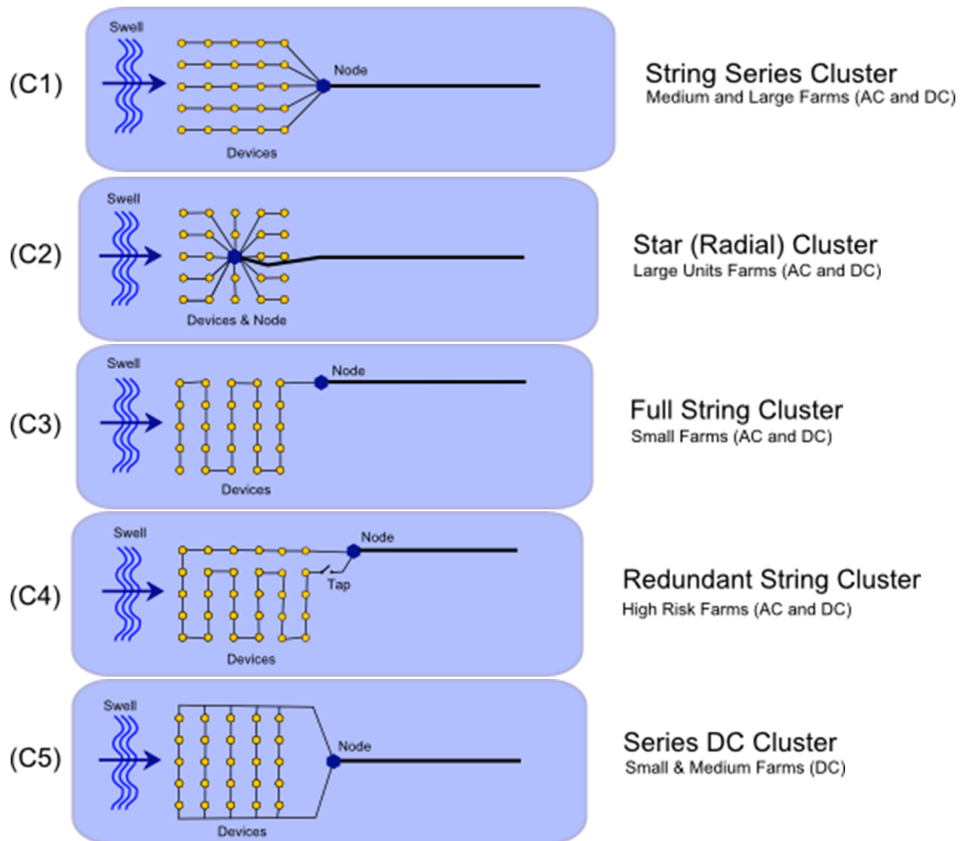

Figure II.C.4: Main types of clustering for marine energy farms.

The developer should assess the cost benefit of individual device connection to shore (for small number of device close to shore) against the use of an offshore hub with higher transmission voltages.

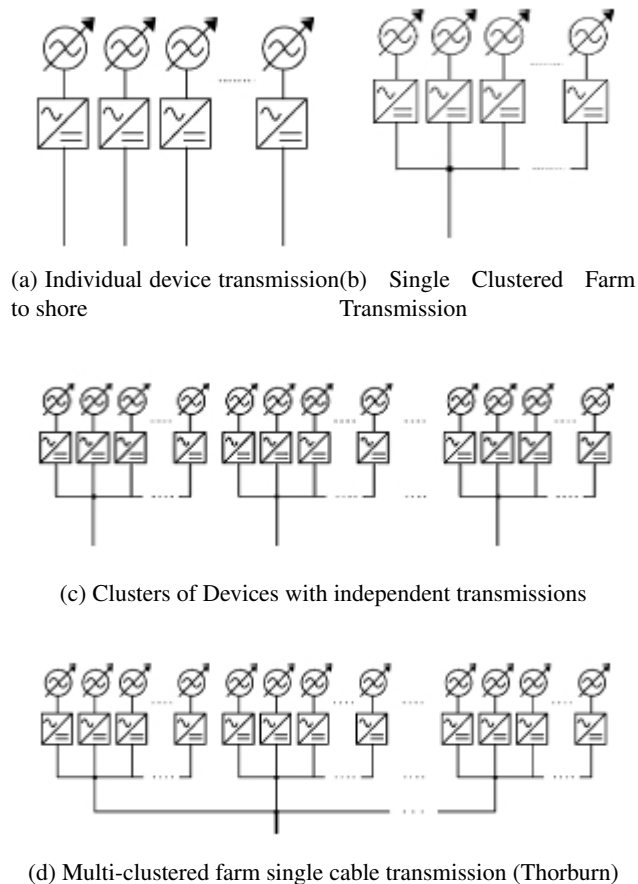

Figure II.C.5: Electrical integration configurations

Guidance on the use of offshore substations

Offshore substations are used to reduce electrical losses by increasing the voltage and then transmitting the power to shore. Generally a substation does not need to be installed if:

- The project is small (100 MW or less)
- It is close to shore (15 km or less)
- The connection to the grid is at collection voltage (e.g. 33 kV)

Early stage marine energy projects are likely to satisfy all of these requirements, therefore building of properly designed offshore substation is not yet a primary need for marine energy deployment. However, most future farms will be large and/or located far from shore, and they will require one or more offshore substations.

A number of offshore substations have been installed and operated for offshore wind energy farms, whose large size justified the high cost linked with their construction. Whilst the structural design of such substations may not apply to wave and tidal environments array developers shall take guidance from their electrical configuration.

Offshore substation will typically comprise the following key components:

- Transformers
- Electrical switchgear

- Back-up electrical generator and batteries

Future large scale marine energy deployment would probably have to reconsider the design of purposely built substation since fixed structures, as introduced, would be too expensive for deep water installations. For such cases there would be essentially two options:

- Floating substations: This option would allow the adoption of standard electrical equipment on board provided that watertight integrity is maintained. Design of these structures would be however rather challenging because they should be capable of withstanding possibly very large wave loads and at the same time guaranteeing a very limited footprint (otherwise umbilical connection from devices might suffer severe damaging)
- Subsea substations: Subsea installations would guarantee more safety in terms of load resistance and positioning but would require very expensive protection equipment for the electrical devices (most likely switchgear should include sealed compartments full of pressurised oil). Moreover maintenance would be very difficult or almost impossible in some cases.

II.C.3.3 Guidance on shared sub-systems and array operations

Key areas where shared subsystems can be employed to reduce operational actions are power take-off and electrical connections.

A power take-off subsystem might be shared between a number of hydrodynamic sub-systems on one device or could be shared by a number of different devices. Power density will obviously be greater but it is expected that CAPEX and OPEX per unit power is reduced if such shared subsystems are employed.

Offshore wind farms now commonly have shared substations on a separate platform, which houses transformers and other power conditioning equipment to enable high voltage transmission to shore. These are generally more accessible than wind turbines themselves, which may require more capital expenditure, but spread over several turbines the benefit outweighs the cost. This is likely to be even more beneficial for wave and tidal energy arrays, which are generally even less accessible than wind turbines due to more extreme metocean conditions. Even for smaller arrays shared electrical connection equipment can be employed. Access is a key issue as a failure at such a nodal point may affect the power production from significant fraction or the entire array.

Guidance on the spatial layout of the array

Reference: For more detailed description of array design and device interaction effects please refer to deliverable D5.4. For information regarding resource measurements refer to part I.A of the protocol. For information regarding single device metocean and device measurements refer to part II.B of the protocol.

The need: Arrays will begin as relatively small installations but will soon increase in size to benefit from economies of scale and shared systems and processes that will serve to reduce the cost of energy. Guidance is required so that early arrays are not only designed in the most effective manner for energy generation but also to serve as a knowledge base for future arrays.

Figure II.C.6: 2-Row wave energy array (left) and 3-row tidal array (right) TODO - missing figures

Array classification

It is likely that arrays will evolve in size and complexity as the technology develops. A useful concept that has arisen from this aspect of the Equimar protocols is the definition of the size of an array. A key driver for nearly all types of wave and tidal device will be the minimisation of negative interaction effects between devices whereby structural loading is increased and/or power production is reduced. Early arrays will most certainly be composed of a single row of devices aligned perpendicular to the incoming wave or tidal resource (where the resource has a low degree of directionality). Arrays can be expanded by including a second row where downstream or down wave devices are positioned in the spaces left between devices in the upstream/up wave row (see Figure II.C.6). This is the limit of what we will refer to as 1st-generation arrays. This configuration has the following benefits.

- It will minimise device interaction
- Maintenance and access to devices is not restricted as both rows can be approached from outside the array
- Arrays can potentially become quite large with this configuration depending upon location

Second generation arrays would be for multiple rows of devices (greater than 2) where interaction effects do occur. The benefits of a large number of devices at the same site outweigh the potential for increased device loading and/or reduced performance and access issues to some devices within the array. Figure II.C.6 (right) illustrates this issue as the furthest row downstream is most likely to encounter some form of negative interactive effects from the upstream rows whilst access to the middle row could be more difficult due to the bounding effect of the two adjacent rows.

The definition given above means that the rated power of an array is independent of this classification. Instead it is driven by the operational complexity of the array.

The classification of arrays in this manner is important as many of the device and performance metrics applied to arrays become more subjective for 2nd-generation arrays. Definition and comparisons between several 1st-generation arrays should, in theory, be easier.

II.C.3.4 Matching devices to the marine environment

Guidance is offered on which parameters should be considered and how device/site matching could be rationalised. Full details can be located in deliverable 5.4.

The report conducted under the Waveplam project offers a methodology for site selection for marine energy projects.

The most common tool utilised for device/site matching is Graphical Information System (GIS) software. Graphical information for an area under consideration can be overlaid (such as bathymetry, wave climate, currents, electrical grid routes) in a graphical software package. Layers can be assigned a value of importance and thus summation over the wider area can yield sub-areas that offer the most beneficial location for wave or tidal energy

devices. This is a simplified definition of GIS, there are other functions that make it a powerful tool but its effectiveness and the end result is ultimately governed by the following parameters:

- Availability of data
- Accuracy / spatial extent of layer information and resolution
- User-defined weighting assigned to specific layers

When conducting GIS (or similar) analysis or when viewing data output all must be aware of these constraints. Device developer or other users may allocate importance or weighting to layers as they see fit however, information regarding the weighting of layers is required in order to fully understand the results. Characteristics which define suitability of a marine energy converter array to a specific site can be categorised under the following areas:

- Physical Characteristics
 - Metocean parameters
- Environmental Constraints
 - Metocean, marine flora and fauna
- Other Users of the site
 - Human industry, tourism, travel, utilities, heritage
- Key installation and operational issues
 - Proximity to electrical grid, port, operation and maintenance base

An expanded version of the parameters above can be found in deliverable 5.4. When considering the location of an array device-site matching should be conducted to demonstrate that the most favourable site is selected based upon the parameters listed in deliverable 5.4.

- Military use of area Submarine, surface vessel exercise areas, ammunition dumps
- Scientific / Environmental protected species of flora/fauna
- Commercial fishing, aggregate dredging, shipping lanes

These can be termed “Showstoppers” an event, action or inherent characteristic that prevents any further development. Such issues should be addressed at the first stage of device-site matching for arrays.

II.C.3.5 Guidance for Interaction effects between devices in an array

At present arrays are at a very early stage of development and therefore the amount and type of guidance that can be given for array layouts and the minimisation of negative interaction effects is limited in certain areas. Therefore this protocol (and supporting documents) will:

- Identify parameters that influence device interaction within an array structure. Give qualitative guidance as to the degree of influence such parameters might have based upon:
 - Related literature
 - Physical modelling
 - Numerical modelling (assuming model is suitably robust)

This protocol will not:

- Be able to give quantitative guidance upon many device specific issues where literature or previous modelling has not been conducted.

Literature concerning device interaction effects from full-scale wind farms and marine energy devices of varying scales has been collated in deliverable 5.4. Marine energy stakeholder should be aware that:

- I. Power losses due to interaction effects are large in multiple row wind farms
- II. Existing numerical and analytical models applied to wind farms increasing under-predict power losses as the number of rows increase
- III. These serious issues are more relevant to 2nd-generation wave and tidal arrays. 1st-generation arrays should not suffer due to the lower occurrence of device interaction.

Stakeholders should be aware that there are several metocean parameters that will influence device spacing within an array.

The region of lower energy down stream or downwave of a device will be wider when the directionality of the incoming resource increases. This effect is illustrated in Figure II.C.7. It follows that if the directionality of the resource is not well understood and the array is not designed for such metocean conditions the degree of device interaction is likely to increase. This will undoubtedly have a negative effect as loading increases and energy capture decreases for devices operating in the wake or energy capture zone of an upstream/upwave device.

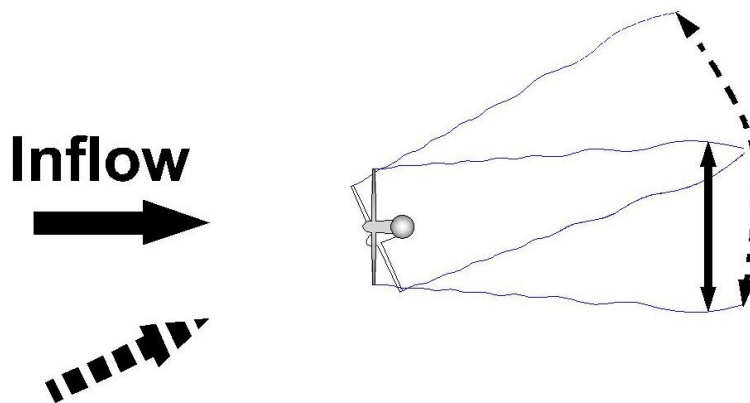

Figure II.C.7: Increase in spatial extent of downstream wake (dashed lines) for increasing directional inflow

The degree of resource directionality should be quantified during the pre-deployment so that such effects can be incorporated into the design of the array.

Bathymetry may affect device interaction within an array. Continuity of depth within and surrounding array area is an important issue. This may lead to changes in direction of waves/tidal currents that could affect the magnitude of device interaction. Varying bathymetry over a tidal energy array could lead to disparate flow velocities and hence varying power production. Changes of bathymetry over short distances would be detrimental to both wave and tidal. For the latter technology strong turbulent structures could be shed at such bathymetric transitions that could negatively impact upon device power production and structural loading.

Short-term unsteady events such as storm surges and freak waves are infrequent and would not affect device interaction within and array as it is most likely that devices would be in survival mode. Thus the fraction of incoming resource harnessed (if any) is smaller than for rated conditions so interaction less likely.

Spatial arrangement of arrays

It is most likely that 1st-generation marine energy arrays will be of a single row configuration arranged perpendicular to the predominant direction of tidal flow or wave (Figure II.C.8). Here the region of flow influenced by the devices (wake) is shown as a shaded region propagating downstream/down wave. In general for wave energy converters the down wave radiated wake will be wider than for tidal energy devices (more comprehensive guidance on this can be found in deliverable 5.4).

The principle device interaction parameter is the distance A laterally between the devices. It is assumed that this arrangement will be beneficial for a number of reasons:

Figure II.C.8: Single row 1st-generation arrays (line absorber (left), point absorbers (centre) and tidal turbines (right) TODO missing figure

- Devices will not operate in the wake flow or radiated wave field region
- Distance A probably will need to be small for interaction effects to occur
- Initial arrays are likely to be composed of up to 10 devices thus lateral coverage at most tidal sites will be small
- Access for installation/maintenance craft is good

Device developers are should conduct trials where the lateral separation distance A is optimised.

It is expected that as the size of tidal arrays increases a dual row arrangement will need to be considered. This is to keep the lateral distance that the array occupies at a manageable level in terms of maritime obstructions and electrical connection. Scale model testing supports the offset row arrangement as shown in Figure II.C.9. This will apply to tidal energy devices and the majority of wave energy devices.

Figure II.C.9: Dual row 1st-generation arrays (tidal (left), wave (right) TODO missing figure

It is intuitive that if distance A is large then the tidal or wave field moving through the gap between 2 devices will remain relatively unchanged towards the centre of the gap. As distance A is reduced the amount of undisturbed tidal/wave energy will also reduce. At some small value of A adjacent devices will affect each other and this is likely to be a negative interaction. It also now follows that there must be an optimal value of A where adjacent device spacing is acceptably small but also where enough of the wave/tidal resource can pass through the gap. Now we have the ideal scenario for an expanded 1st-generation array with 2 rows.

Distance B will be optimised where the downstream/wave row is operating in flow conditions similar to that of the first row.

As the wake or radiated wave field will tend to diverge this further supports the theory that there is an optimal value of B depending upon device type, operation and met-ocean conditions. The number of metocean and device parameters means that definitive values for A and B cannot be given at this time. We can inform device developers in a generic manner to empower the industry to acquire data to optimise inter-device spacing. Device developers are encouraged to forward plan single row arrays to incorporate installation of a second row at a later date by measuring the metocean resource downstream of a single row array (see D5.3). 2-row arrays will hold a number of benefits:

- Downstream/ down wave devices can experience the same inflow characteristics of those upstream/up wave
- Distance B probably will need to be small for interaction effects to occur
- Almost double power output over single row array for similar array lateral width
- Installation/maintenance craft can gain access to all devices from both sides of the array

An exception is likely to for point-absorbing wave energy devices. Here the radiated wave fields can be used to increase performance of another device. Therefore the guidance for 1st-generation arrays (as defined in this protocol) may not apply and such devices may be installed as 2nd-generation arrays at an early stage of development.

Once arrays reach sizes whereby the offset 2-row arrangement occupies a disproportionately large lateral distance of an array site then devices will need to be arranged in larger numbers with additional rows of devices (Figure II.C.10). Here the 2-row offset pattern is repeated with subsequent rows. We now have a 2nd-generation array as defined previously.

Figure II.C.10: 2nd-generation arrays (tidal (left), point-absorber wave (right) TODO missing figure

Distance C refers to a distance directly downstream / down wave between two devices.

This is not used for point-absorbing wave energy devices as their down wave spacing is likely to be equal between rows.

Increasing the distance C will reduce the degree of interaction which is negative i.e. the 3rd row device will generate less power than the devices upstream / upwave. Large arrays are unlikely for 2-row 1st-generation arrangements due to constraints discussed previously therefore 2nd-generation arrays with zero device interaction are probably unrealistic. Thus C will be determined on a site by site basis with a natural trade off between limiting negative interaction effects whilst maximising energy capture from the array as a whole.

The optimal value of C will vary based upon a number of parameters discussed in earlier in this section of the protocol. At this time there is no quantitative guidance that can be given for this. Reference is made to deliverable 5.4, specifically literature covering power losses in wind farms. Once again device developers and operators of 2-row arrays are encouraged to quantify downstream flow conditions in order to inform existing array expansion or layout of new 2nd-generation arrays.

Key areas of guidance for the spatial layout of arrays

- I. Deployment of arrays will be incremental so initial small-scale deployment should not compromise the final large-scale array. This forward planning should be considered from the first stage of array design.
- II. Investigation into device interaction should be minimal for single row arrays with some exceptions (point-absorbing wave devices).
- III. 2-row 1st-generation arrays will require investigation of 2 key device separation lengths. Device operation in radiated wake region can and should be avoided.
- IV. The principal exception to point 3 is point-absorber wave energy devices. Here positive interaction under certain wave conditions may promote operation in device-radiated wave fields.
- V. 2nd-generation arrays will undoubtedly involve device operation in radiated flow fields from upstream/upwave devices. Device spacing should be optimised based upon cost/benefit principles.
- VI. Other issues such as device installation, accessibility and metocean conditions may drive elements of 2nd-generation device spacing.
- VII. Device developers and relevant industry stakeholders are encouraged to explore such issues to ensure that arrays develop in a progressive and logical manner leading to optimized installations producing the maximum amount of energy from the marine environment.

II.C.3.6 Guidance on impacts to marine energy stakeholders

Stakeholder interaction will vary by country and potentially by region if, for example, devolved financial and policy conditions exist.

A stakeholder map will be generated for this section of the protocol such that areas of stakeholder interest surrounding array pre-deployment, and operation can be attributed. This can then be related to a specific area/county etc. where the array is located.

II.C.4 Performance Assessment

II.C.4.1 Quantification of performance parameter for arrays and individual devices

Reference: For more detailed discussion and description please refer to deliverable 5.3. Part I.A of the protocol gives guidance for single point measurements of the wave and tidal energy resource. II.B (sea trials) also gives a good insight into applicable device specification and data acquisition requirements for wave and tidal devices.

The need: Arrays of wave and tidal energy devices will require a precise set of performance metrics with which can be used for absolute and comparative purposes. Many of the device specifications have been addressed previously within the device classification template section of this protocol. This section deals with more general definitions that quantify the performance of an array as a whole.

II.C.4.2 Quantifying the inflow to an array

The need for accurate quantification of inflow conditions is important at the planning, installation and operational stage of the array. Forces acting upon devices and power production are often sensitive to small variation in metocean resource therefore the need for a high level of accuracy is clear.

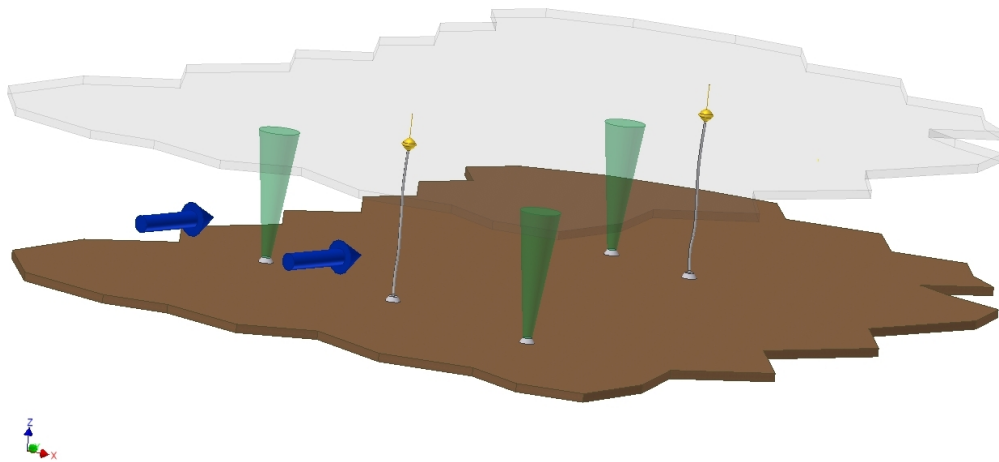

Figure II.C.11: Array resource measurements might require increased spatial coverage.

For tidal energy if the water depth remains constant across an area including the array and outside its spatial footprint it is reasonable to assume that the inflow is relatively constant with lateral distance (perpendicular to the principle direction of flow). Developers shall still seek to prove this with in-situ measurements. As it the case with wind turbines that extract kinetic energy from moving fluid inflow velocity measurements should be made upstream at a point in the flow that is not influenced by the operating devices. This distance is generally taken to be 5-characteristic lengths of the hydrodynamic subsystem e.g. 5 horizontal axis rotor diameters (or equivalent characteristic length).

For tidal devices within an array the principle driver for varying inflow across an array will be changes in water depth. An array covering an area with varying bathymetry will require distinct inflow measurements dependant upon the degree of inflow variability as illustrated in Figure II.C.12.

Step changes in bathymetry upstream can shed turbulent structures far downstream so appropriate mapping well upstream of the array is recommended even if at lower resolution than that employed close to the array footprint. Shipping charts and a range of different resolution bathymetric surveys are often available for most areas close to shore and should be used appropriately to assess whether any change in inflow across a tidal array might exist.

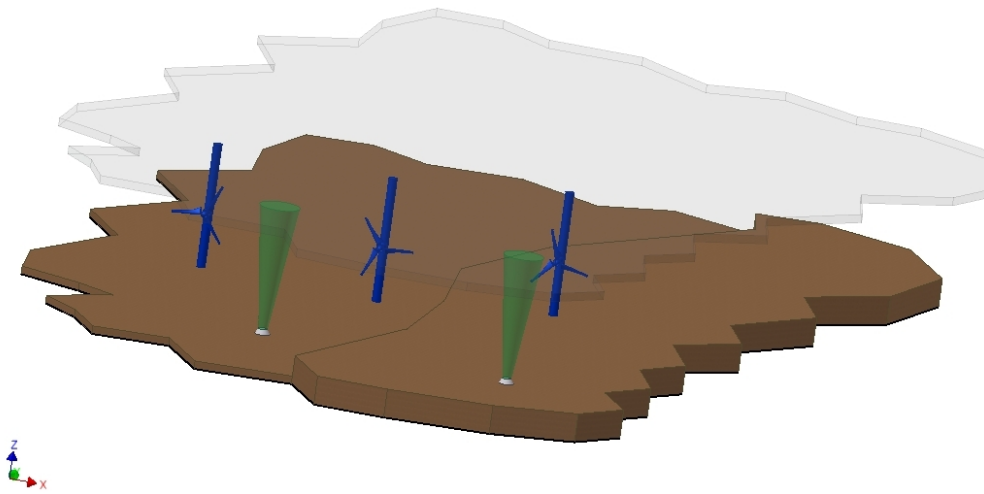

Figure II.C.12: Tidal Array installation over varying depth will require increased measurement to accurately define inflow conditions.

It is recommended that if inflow conditions are thought to vary that site resource assessment for an array consists of several locations of measurement. These can be conducted incrementally if the array is to be constructed in a modular fashion.

The wave energy inflow is best quantified by a directional wave-buoy (or equivalent instrumentation) ahead of the array by a distance sufficient for it not to be substantially affected by the WECs in the array, e.g. of the order of one to a few hundred metres depending on the size of the WECs. In an area of deep water (i.e. greater than half the wavelength of the waves being absorbed) this single measurement may suffice as inflow characterisation. However, in shallower water, perhaps with complex bathymetry and perhaps with local sheltering characteristics, predicting the wavepower at points within the array may need, in addition, the use of a nearshore wave transform program that models the bathymetry and local coastline and is driven by the incoming directional wave field data.

II.C.5 Modular installation of arrays

Further to the definition of 1st and 2nd generation arrays device developers are encouraged to deploy additional resource measurement equipment at 1st generation sites for the following reasons:

- To gather down stream/wave measurements for array expansion at that site
- To provide understanding of down stream/wave that can be used to inform array design at other locations

Figure II.C.13 illustrates this concept using targeted measurements around a 1st-generation single row tidal array. Inflow is measured upstream of the array. Measurements to quantify the available resource to a second row of devices are staggered allowing 2 different

locations to be evaluated. It would be prudent to deploy measurement equipment in such locations simultaneously to reduce costs. The flow measurement points for the 3rd-row are also staggered in a similar manner; it is assumed that the energy capture of the devices in the single row array will be equal thus justifying this approach. In the case of tidal energy these measurements can also be used to quantify the inflow to the array when the tide turns. For wave energy this is not required as the predominant wave direction is generally strong.

Figure II.C.13: informing array design through additional resource measurements. TODO missing figure

Quantification of array performance parameters

Definitions are presently in draft format with the IEC document IEC/TC 114/PT 62600-1 regarding Marine Energy Terminology. They are repeated here for completeness (in *italic text*) in addition to those addressed herein that are more specific to arrays.

Rated Power

Rated power is not really fixed even for a given hardware configuration. The rated power of a device generally defined as the manufacturers nameplate power on the machine and is nearly always the maximum electrical output of the generator. Justification of this is given in deliverable 5.3. For arrays the simple, practical definition of rated power is the grid connection capacity (defined by the sum of the nameplate rated power) divided by the number of machines.

Array conversion efficiency

Electrical power output compared to the captured power where captured power at the rear of the device and the electrical power output at the grid delivery point.

Availability IEC/TC 114/PT 62600-1 defines availability as:

3.7 Availability (power production)

Ratio of the total number of hours during a certain period, excluding the number of hours that the marine energy converter could not be operated due to maintenance or fault situations, to the total number of hours in the period, expressed as a percentage

3.8 Availability (resource)

Ability of an item to be in a state to perform a required function under given conditions at a given instant of time or over a given time interval, assuming that the required external resources are provided.

Some devices might employ ‘graceful degradation’ when a fault is encountered. Here performance is reduced but the device still operates at reduced power. This is a cost-effective alternative to binary availability - and an alternative to the ‘fraction of time’ definition given at the start of this section. It is particularly appropriate for marine devices where access for maintenance may be severely constrained due to cost (e.g. vessels or divers) or weather. Availability is a difficult parameter to fix because it is subject to uncertainty of failure occurrence, type and the costs of remediation. This uncertainty is mitigated by experience.

For arrays the availability should be aggregated over all devices. Therefore if 10% of devices are not in operation over 50% of the year the array availability will be 95%. It is then more difficult to account for ‘graceful degradation’ within an array as unless declared (or detected). Instead it will manifest as a reduction in power output that can be expressed in terms of a reduced capacity factor (defined below).

Capacity factor

IEC/TC 114/PT 62600-1 defines capacity factor as:

3.10 Capacity factor (energy)

Ratio of the energy that an electric generating system actually produces which would have been produced had the rated capacity been utilized for the given period

Once again for an array the rated capacity is defined for the array as a whole.

Capture width

A useful quantity widely used in the wave energy industry is the ‘capture width’ of a machine. This is the mechanical power developed by the machine, in watts, divided by the mechanical power in the waves, in watts per metre of wave front. The result is termed ‘capture width’ and is equivalent to the width of wavefront in metres over which all energy is captured. For example a machine might have a capture width of 30 metres: this does not mean, of course, that a width of 30m spanning the machine is reduced to total calm; it means that behind the machine there is an area of reduced wave height, considerably wider than the capture width, and tapering away downwave of the machine as the free field re-energizes the wake, much as for wind turbines. The capture width can be specified as a frequency-dependent quantity when it is measured in single-frequency waves, or as an aggregate Figure in a given, specified irregular sea.

The capture width depends on the size of the machine and, to compare machines fairly, allowance should be made for this. One can produce a non-dimensionalized number by dividing the capture width by some length characteristic of the machine. One proposal for the characteristic length is ‘displacement width’, namely, the cube root of displaced volume. The resulting non-dimensionalized capture width is then correctly scale- independent and, moreover, shape-independent. The differences between different machines of this non- dimensionalized capture width will then be due to operating principle, technology etc. not on size or shape.

Spacing number

A second non-dimensionalized number would be useful in the case of arrays, namely a spacing number, being the average spacing between machines divided by the capture width. In general developers will be concerned, for economic reasons, to keep the spacing number low because this offers potential savings in electrical cabling, mooring emplacement and other infrastructure, but within the constraints of keeping negative hydrodynamic interaction between devices low and, of course, ensuring there is no risk of unwanted mechanical interference.

II.C.6 Recording and reporting of temporal information

Awaiting content from deliverable D5.6

TODO

Chapter III.A

Project Assessment

TODO Introduction omitted as with other chapters

III.A.1 The Need for Economic Assessment of A Marine Energy Project

Typically a number of design options will be available for a marine energy project. **The objective of a project assessment is to identify the marine energy project design which, subject to levels of uncertainty consistent with the project and technology development stage, satisfies a specified set of investment criteria.** To achieve this it is necessary to:

- A. Quantify expenditure over the project life (Section III.A.2 and III.A.3)
- B. Quantify revenue over the project life (Section III.A.4)
- C. Identify risks associated with the project and assess their effect on quantitative measures of economic viability (Section III.A.5)
- D. Calculate a set of quantitative parameters to compare to specified criteria for economic viability (Section III.A.6)

III.A.1.1 Reporting from Economic Assessment of a Project

The output of a *Project Assessment* should be a **report** including:

- Statement of the summary parameters obtained from the economic assessment
 - The parameters that are required by the investor to evaluate the investment must be stated
i.e. Net Present Value of XX for constant discount rate of XX, Payback within XX years
- Statement of major capital cost components
 - Itemise all expenditures (Section III.A.2) and, for each item:
 - * A single unit cost stated.
 - * A single quantity stated.
 - * Confidence in the unit cost and unit number stated (Section III.A.4).

- Statement of method used to determine cost of site-to-shore transmission system.
- Statement of major contributions to expenditures during the operating phase of the project. These must include periodic and unplanned maintenance activities and any other expenditure required to continue operation.
 - Itemise all tasks required to conduct a minimum planned maintenance schedule that is sufficient to provide the project availability and energy generation assumed when calculating revenue.
 - Identify failure modes that would require unplanned maintenance.
 - All ongoing expenditures should be itemised (Section III.A.3) and, for each item:
 - * A single unit cost stated as used in calculations.
 - * A single number of units stated as used in calculations.
 - * Confidence in the unit cost and unit number stated (Section III.A.4).
- Statement of expected project revenue
 - State project energy production. This must be based on the state of technology development (IIA, IIB or IIC) and on the resource at the site under consideration (IA).
 - State project availability. This should be based on considerations for an array as per IIC.
 - State market conditions in which the project is assumed to operate.
- Statement of methods used to quantify risk and statement of project risks:
 - Uncertainty associated with each unit cost and quantity should be stated.
 - Critical risks must be identified.
 - Risks specific to the project must be identified.
 - Aspects of design or costing that are difficult to quantify should be identified

The level of detail of the assessment and confidence margins stated should be consistent with the level of development of the technology to be installed and of the resource assessment. Table III.A.1 identifies appropriate methods for the main stages of the assessment for technologies at different stages of development.

III.A.1.2 Assessment Method

The economic assessment of a project should:

- Identify all significant expenditures and revenue streams;
- Identify the underlying factors which could significantly effect the economic viability of a project;

The economic assessment of a project should also account for the risk and uncertainty associated with both the inputs used and the assessment process. This should be to a level appropriate to the technology development stage, to the accuracy with which Metocean conditions are known and to the confidence in the value of input values such as unit costs and material quantities. Three stages of technology development are identified in table III.A.1.

Development Stage	Concept Model (Pre IIA)	Interim tank testing (Post IIA)	Scale proto-type tested offshore (Post IIB))
Capital cost -Based on material volumes -Based on complexity of system -Component quotations	Y Y	Y Y	Y
Installation Time -Comparable site -Persistence statistics -Analysis of time-history	Y*	Y* Y*	Y
Operating Cost -Percentage of capital expenditure -Minimum and range -Detailed maintenance schedule	Y	Y	Y
Revenue -Energy output -Availability -Resource	IA (I.A.2.1)	IIA IIA IA(I.A.2.1)	IIB IIC IA(I.A.2.1)
Unit Cost Estimates -Single value -Distribution of values -Quotations -Forecast	Y Y	Y Y	Y Y n/a
Investment Risk -Generic discount rate -Project specific discount rate	Y	Y	Y
Project Risk -Critical risk identification -Risk Schedule and Mitigation	Y Y	Y Y	Y Y

(*)

denotes application to wave energy technologies only)

Table III.A.1: Summary of **methods** and data required for economic assessment for three different stages of development of an arbitrary marine energy conversion technology.

III.A.2 Capital Cost - Methodology

Objective: Must identify and quantify all expenditures required for commissioning of a project with the availability and power output assumed in the revenue calculation (see Section III.A.3).

Process: All expenditures should be itemised and, for each item:

- A single unit cost stated as used in calculation of economic parameters (Section III.A.6)
- A single number of units stated as used in calculation of economic parameters (Section III.A.6)
- Confidence in the unit cost and unit number should be stated (Section III.A.4)

Figure III.A.1: CAPEX Calculation Flowchart (Fig 1, EQUIMAR D7.2.1) TODO - figure missing

A schematic of the main cost areas to consider is given in Figure III.A.1 . The following items of capital expenditure must be included:

- Preliminary works,
- Fabrication & Manufacture of marine energy devices and associated infrastructure
- Site to grid transmission structure (using appropriate method)
- Deployment,
- Decommissioning,
- Expenditures required to provide the minimum maintenance scenario (see Section III.A.3)

Sections III.A.2.1 - III.A.2.6 identify the items to be included and factors to be considered within each of these cost areas.

III.A.2.1 Preliminary Works

Many of the preliminary costs will be similar for alternative projects of similar power output at the same site. These include:

- Site surveys as per IA and IB
- Licenses, consents, notifications and approvals
- Project management

The following costs should also be included:

- Costs incurred for infrastructure needed to provide the unit costs used in the assessment
 - i.e. manufacturing facilities.

- Costs incurred for infrastructure or equipment needed to provide installation schedule (Section III.A.2.4)
 - i.e. special purpose vessels or specific onshore facilities.
- Costs incurred for infrastructure needed to provide the assumed maintenance schedule (Section III.A.3)
 - i.e. special purpose vessels or specific onshore facilities.
- Costs incurred for mitigation of other risks (Section III.A.5)

III.A.2.2 Marine Energy Devices

Alternative device concepts comprise many individual components and manufacturing techniques. The number of marine energy devices within the project must be identified and a cost per device obtained by a suitable method. In contrast to many components of a marine energy farm, marine energy devices may only be available from a single supplier. Therefore costs quoted by developers should be independently assessed where possible.

III.A.2.3 Civil Engineering Infrastructure

Must include all components required to hold all marine energy devices in place at the deployment site. The costs of the civil engineering infrastructure required must be based on the number of devices installed, their configuration within a farm and on the inter-device spacing. The costs associated with installation of civil engineering infrastructure must be included subject to vessel- and environmental conditions (see Section 2.4).

Station-keeping systems vary with device type but typically comprise either a mooring system for floating devices or a support structure for bed-mounted devices. For offshore floating converters, moorings are usually separate systems that allow the device to move independently within a limited range and are required to prevent drifting of the device. For bed-mounted devices, the support structure may be integrated into the design of the tidal-stream or wave device to resist horizontal loads on the device.

Note: Since design of foundations and moorings has been common practice for decades in offshore oil and gas extraction many standards on mooring design criteria are available and cost accounting procedures of mooring systems have been defined. However, the different scale of oil & gas projects and different safety requirements implies choices that would not be cost-effective at all if applied to marine energy projects. Care should be taken to limit reliance on cost estimates published for oil & gas infrastructure.

The following sections identify factors that must be considered when itemising the capital cost associated with mooring systems and bed-connected support structures for a marine energy project.

Mooring systems

Capital cost of such systems should be based on the following factors:

- Complexity of components and overall mooring system: additional cost implication
- Mooring line or chain loading requirements: lower cost for provision of horizontal restoring force

- Anchor requirements: dependent on the required load capacity and direction, weight and site geotechnical conditions
- Footprint area requirements: in general a smaller footprint will be associated with a smaller cost
- Provision of redundancy: additional cost implication but increased availability
- Novelty: additional cost implication due to design uncertainty and safety factors.
- Number of anchor units installed - cost per unit varies with number of units
- Installation costs for all components of the mooring system must be considered as per Section 2.4.

An example of how these factors affect the relative cost of several generic mooring systems is given in EQUIMAR D7.3.1.

For mooring systems, the following components are expected to represent a major fraction of capital cost and so their cost must be itemised:

1. Chains and lines are the largest cost factor.
2. Cost of anchors is dependent on required holding power and weight and this is sensitive to subsurface geotechnical conditions.
3. Connectors (shackles etc)
4. Buoys and clump weights

Bed-connected structures

Capital cost of supporting structures should be based on:

- Geotechnical conditions at the deployment site
- Horizontal loading defined by Metocean conditions for the deployment site (see IB)
- Material weights and complexity.
- Installation costs must be considered as detailed in Section 2.6.

For supporting structures, the major components of capital cost are procurement, fabrication and installation. Procurement and fabrication costs should be based on steelwork weights obtained from structural design and appropriate unit rates such as raw material costs. Fabrication rates for structures depend on the complexity of the structures involved and the amount of welding required. Cost estimates should therefore be based on a design that is sufficiently detailed to estimate material weights and fabrication complexity. An indication of the level of detail required for assessing structure cost is given in EQUIMAR D7.3.2.

III.A.2.4 Electrical Infrastructure

The cost associated with an inter-array cable must account for: cable length, cable capacity, installation method and configuration of the inter-array cabling. Details on the configuration of alternative cabling systems are given in EQUIMAR D5.1. Alternative configurations include:

String collection - comprising a series connection between multiple generators.

Capital cost of such systems must include:

- Availability (decreased) or maintenance cost (increased) must account for the fact that multiple generators will be isolated during a repair.
- Number of generators per string is limited by the rated power of the cable used.

The following could be accounted for:

- Simple cable 'laying' pattern and shorter cable lengths relative to a star pattern (This is particularly relevant for bed-mounted devices such as many tidal stream turbines or some wave devices).

Star collection - comprising a direct connection between each generator and a transformer

Capital cost of such systems must include:

- Transformer station and supporting platform or subsea foundation
- Switchgear to allow isolation of individual generators

The following could be accounted for:

- Low cable losses due to high voltage cables
- Availability (increased) or maintenance cost (decreased) to account for the fact that single generators can be isolated during a fault

Some developers propose the use of hydraulic system to transfer energy between individual marine energy devices and a generator. Farms comprising such systems must include the cost of design, manufacture and installation of the hydraulic system.

III.A.2.5 Site to grid transmission

Costs associated with design, manufacture and installation of the system required to transfer energy from the marine energy device deployment site to a grid connection point must be included in the assessment. The system used will vary with technology.

Many developers propose electricity generation within the marine energy device. For these technologies, all costs associated with deployment of electrical transmission cables and associated infrastructure must be considered. Guidance on the cost of electrical transmission systems is given in EQUIMAR D5.1 (also Lopez et al. ICOE 2010¹). The capital cost for an electrical transmission system must consider, distance to shore, electrical power

¹Lopez, Ricci, Villate, Bahaj, Myers, Retzler and Dhedin (2010) Preliminary Economic Assessment and Analysis of Grid Connection Schemes for Ocean Energy Arrays. Proc. 3rd International Conference on Ocean Energy. 6 October 2010.

generated in the farm, AC or DC connection. The main costs are represented by the foundations, generators and onshore (grid) connection. These costs increase with increasing distance to shore and water depth. The electrical equipment (switchgear and infield cables) is a minor part of the overall costs and is nearly independent on distance to shore.

Some developers propose the use of hydraulic pipelines to transfer energy to the shore. For these technologies, all costs associated with deployment of hydraulic transmission systems and off-site power generation must be considered.

III.A.2.6 Deployment - Offshore Vessels

It is known from published experiences of offshore wind energy projects that deployment costs are sensitive to both the type and duration of offshore work. To quantify the installation costs associated with a marine energy project it is necessary to determine both the type of vessel required and the duration of vessel time required. Since vessel costs vary with schedule, site and technology, a cost per installed capacity or cost per installed device should not be used.

Vessel Type

Suitable vessels must be identified for installation of all components of mooring systems, support structures, electrical infrastructure and marine energy devices. Most of the offshore floating wave energy converters currently being developed could be towed to the deployment site through the use of vessels generally operating for offshore oil and gas industry. Specialist vessels will be required for specific tasks such as pile installation, cable laying or anchor handling. For complex projects requiring a variety of vessel types, the costs associated with each vessel type should be considered separately.

Unit Cost of Vessels (see Appendix B of D7.4.1)

Unit cost - i.e. cost per day - for vessel rental must be obtained from an appropriate supplier. Most vessels are operated by supply boat companies and are rented by oil companies either by day or on a longer term basis for specific projects. For the foreseeable future, the marine energy industry is likely to employ the same contracting process although a marine energy specific vessel market may develop with the industry. Vessel rates can vary considerably due to both demand variation and the need to await environmental conditions that are suitable for installation.

Vessel rates are particularly sensitive to demand and so average day-rate and variability of day-rate will be lower for vessels that are widely available. Higher day-rates and greater variability of day-rate is observed for specific vessels (such as jack-up barges, heavy lift vessels, and large cable laying vessels) since only a handful of these vessels are available globally. At an early stage of technology development a long-term average rate may be employed (Carbon Trust, 2006). In this case, a contingency budget should be included to allow for future variation of costs. At later stages of technology development quotations should be employed allowing a reduced contingency budget.

For some marine energy technologies special purpose vessels are proposed that can undertake installation and maintenance tasks with greater efficiency than standard oil & gas vessels. One or more dedicated vessels may be constructed by a technology developer for use at multiple sites or for a specific project. A representative component of the capital cost

of such a vessel must be included in the assessment and an appropriate operating cost employed for the vessel day-rate. If the vessel is constructed for use at a specific project then all design, manufacture and operating costs should be included in the economic assessment of the project.

Duration of Offshore Vessel Use

The duration of vessel time for which costs are allocated must account for the:

- Duration of offshore work required for installation & deployment of all project components.
- Duration for which conditions at the deployment site are suitable to conduct the offshore work.
- Time required for transit between a suitable port and the deployment site

The *duration of calm conditions required* to complete the necessary offshore activities is dependent on the proposed installation schedule. For projects comprising a small number of devices or located at relatively calm sites, sequential installation may be possible using a single vessel. For projects comprising large numbers of devices, which may be located at more energetic sites, installation may require simultaneous use of a number of vessels. The schedule considered must be clearly stated in the economic assessment of the project. The installation schedule must take account of the period for which environmental conditions are sufficiently calm for vessels to operate at the deployment site.

The *duration of conditions that are suitably calm* for conducting offshore work depends on the specification of the vessels employed and on several environmental parameters including wind speed, significant wave height and current speed. Since commercial scale projects are likely to be deployed at sites where waves and currents are more energetic than both demonstrator projects and many offshore wind projects, the duration of conditions suitable for access will be shorter and so extra vessel time will be required to wait for suitably calm conditions. This is a particularly important consideration for tidal stream sites where conditions suitable for installation and maintenance work are dependent on the joint occurrence of flow-speed and wave conditions.

A 'waiting on weather' allowance of several extra days must be made for each day of working time to allow for a period of inactivity whilst the vessel is available but not used. The amount of time allocated should be based on an analysis of the MetOcean conditions at the site by one of the following methods:

- A nominal allowance may be made based on experience of similar offshore operations or on the analysis of deployment sites with comparable long-term statistics. An indication of the number of days of accessible conditions suitable at wave sites with different average values of annual wave power density (kW/m) is given in EQUIMAR D7.4.1.
- Statistical model of persistence conditions based on long-term wave conditions. This method is appropriate to wave energy sites.
- Analysis of a long-term time-history of environmental parameters from the deployment site. This method should be used when more than one environmental variable effects identification of suitable conditions. This method is appropriate for tidal stream sites.

Table III.A.2: Methods for determining the duration of conditions suitable for offshore work.

Method	Wave Energy Project			Tidal Stream Project		
	Pre IIA	Post IIA	Post IIB	Pre IIA	Post IIA	Post IIB
Comparable site	X			X		
Persistence		X				
Time-History			X		X	X

Table III.A.3: Example list of other costs that may be incurred prior to commissioning.

Item	Need	Process
Contingencies	Damage and repair during construction.	e.g. 10 to 15% of standard construction rate.
Measurement instrumentation	To quantify incident conditions.	Cost of instrumentation as defined by IA
Management	To maintain stated schedule.	Indicative ranges
Pre-deployment testing	To ensure specifications satisfied.	As defined by IIB, IIC
...

Transit & Mobilisation Time

The time required for vessels to access the site from a suitable port must be included in the total vessel time. This should be based on the distance between port and site and the vessel speed. The time required for vessel mobilisation and demobilisation should also be included. These are costs associated with relocation of vessels to an appropriate port or site. An indication of these costs is given in EQUIMAR D7.3.2.

III.A.2.7 Other capital expenditures

All other expenditures that are required prior to project commissioning should be included in the assessment of capital cost. Table III.A.3 provides examples of capital expenditures that should be considered.

III.A.2.8 Decommissioning

Decommissioning *at the end of the project life may take many forms. Options include retrieval to shore for scrapping or disposal at sea (e.g. in the form of an artificial reef).* Depending on the disposal strategy the costs associated with decommissioning may be offset by the scrap value of the device. The multi-decade design life of MECs and, the use of discounting (Section III.A.5.2), is such that the costs of decommissioning tend to be relatively modest when viewed from the outset. Decommissioning expenditures should be estimated using the same process as deployment costs (Section III.A.2.6).

III.A.3 Operating Cost - Methodology

Objective: Must identify and quantify all ongoing costs that are necessary to provide the availability and device performance employed in the energy generation calculation (see Section 4) for the itemised project infrastructure (see Section 1).

Process: All expenditures should be itemised and, for each item:

- A single unit cost stated as used in calculation of economic indicators.
- A single number of units stated as used in calculation of economic indicators
- Confidence in the unit cost and unit number should be stated (Section III.A.4)

Figure III.A.2: OPEX calculation flowchart (Fig 2, EQUIMAR D7.2.1) TODO - figure missing

A schematic of the main cost areas to consider is given in Figure III.A.2. The following items of operating costs must be included:

- Periodic expenditures
- Planned maintenance (servicing)
- Unplanned maintenance (repair)

III.A.3.1 Ongoing costs (Periodic Expenditures)

All ongoing costs that are required to provide the availability and device performance employed in the revenue calculation (Section III.A.4) must be included. These include (but are not limited to):

- Insurance,
- Site lease,
- Grid transmission charges,
- Management,
- Costs associated with environmental monitoring activities (see I.B).
- Taxes and government subsidies relevant to the deployment site.

III.A.3.2 Maintenance

The planned maintenance activities for the project must be clearly defined. It is convenient to consider planned maintenance and unplanned maintenance (i.e. repair) separately. There may be significant overlap between these two categories, but the distinction is important as it allows a more logical appraisal for a variety of maintenance and repair strategies. This approach also provides a direct connection to the Availability Factor of the project.

Planned maintenance:

All planned maintenance activities that are required to provide the availability and device performance employed in the power generation calculation (see Section III.A.4);

Planned maintenance costs must include all costs involved with servicing the devices in the marine energy project. This includes elements such as consumables, spares, labour and vessels. The costs directly incurred in the servicing of the device should be reported

on a cost-per-device basis. The capital cost associated with onshore infrastructure or dedicated maintenance vessels should be included under Section III.A.2.1. Maintenance vessel requirements are given in III.A.3.2. There are clearly a number of maintenance schedules available, including service-on-site and return-to-shore options. If the devices are retrieved to the shore for maintenance then the costs associated with this must be included. The project assessment should state the planned maintenance schedule and account for the affect of maintenance on the availability factor.

Unplanned maintenance:

The conditions under which unplanned maintenance would be required should be identified. The activity, duration and unit cost of this activity should be stated.

The repair strategy for devices is potentially more complex than the maintenance strategy due to the significant uncertainty associated with predicting reliability for early stage technology. The costs associated with repair are calculated using a similar methodology to the planned maintenance costs. Costs are assigned to the access of the device (through vessel rates) and to the repair itself. The frequency of repair visits (or device retrieval operations) is determined by the failure rate of the device. The simplest scenario in terms of repair strategies is that the device is repaired on demand. In this case a Response Time element is included in the analysis, this being the mean expected time that will pass before the repair operation can commence. A response time should be determined based on the environmental conditions at the deployment site (see Section 2.4.3 TODO resolve ref). The impact of response time on the Availability Factor, and therefore on the collected revenue must be considered.

Repair costs cannot necessarily be entirely separated from planned maintenance since work conducted on failed devices is unlikely to be carried out entirely independently of scheduled servicing. For example, a decision may be made to postpone repair of a device until visited (or retrieved) for scheduled maintenance. This will be the case where a device has been designed with redundant systems or can operate sub-optimally until the scheduled maintenance.

The mean failure frequency must be estimated based upon an engineering appraisal of the device design. In some cases failure distributions may be available for individual components, particularly if they are established technology bought “off the shelf”. Care must be taken, however, if these components are being deployed in an environment significantly different from their usual operating conditions. Data from prototypes and sea trials should be incorporated into failure rate estimation wherever possible (see IIB and IIC).

Vessel Requirements

Vessel costs for maintenance activities should be estimated using a similar approach to Section 2.6. However, an alternative vessel type may be required. The vessel time required should be determined based on the required maintenance time (Sections III.A.3.2 and III.A.3.2), the maintenance strategy employed and the duration of accessible conditions at the deployment site.

At the concept stage a simple approach may be considered by assuming no link between the planned maintenance (servicing) and unplanned maintenance (repair). In this case there will be a certain frequency of servicing “operations” required for each device. This approach also allows for the downtime associated with maintenance operations to be fed

into the calculation of the Availability Factor. This method is appropriate for marine energy projects where the planned maintenance intervals are large.

At later stages of technology development it may be unrealistic to assume that repairs will be undertaken entirely separately to the planned maintenance operations. In this case the access costs (e.g., vessel hire) associated with repair may be assumed to be some proportion of the full rate. For example, if all repairs are conducted alongside planned maintenance operations the access costs may be assumed to be zero. The mean response time should also be adjusted to reflect the repair strategy and the impact on availability considered.

III.A.4 Revenue - Methodology

Objective: Must identify and quantify the revenue that would be produced by the marine energy devices and project infrastructure (see Section 2) when operating with the availability provided by the defined maintenance schedule (see Section 3) and subject to the Metocean conditions expected at the deployment site.

Process: Revenue from the marine energy project should be calculated as the product of energy generated by the project and the value per unit of electricity appropriate to the site.

Figure III.A.3: Revenue calculation flowchart (Fig 3, EQUIMAR D7.2.1) TODO - figure missing

There are three main stages to the revenue calculation (see also Figure III.A.3):

- Quantify energy production,
- Determine unit value of electricity and
- Obtain revenue by a method appropriate to the stage of development of the technology.

III.A.4.1 Energy production

The minimum energy production should be stated based on:

- The number of marine energy conversion devices for which capital expenditure has been itemised.
- Site Metocean conditions according to the criteria specified in “I.A Resource Assessment”;
- Calculations of device output, provided by the device developer according to the criteria specified in
 - “II.A Tank Testing”
 - “II.B Sea Trials” or
 - “II.C Deployment and Performance Assessment of Multi-Megawatt Device Arrays”

depending on stage of development of the technology.

- The marine energy device availability that is provided by the minimum maintenance strategy (see Section III.A.3)
- All transmission and conversion losses between output from the marine energy project and the grid connection point. (see EQUIMAR D5.1)

III.A.4.2 Unit value of electricity

The value of each unit of electricity must be determined based on:

- The market value of a unit of electricity appropriate to:
 - the operating period
 - the market conditions relevant to the grid connection
 - the predictability of energy production
- Regional or project specific incentives such as Renewable Obligation Certificates, Feed-in Tariffs, etc.

The scale of the marine energy project should also be considered

- Small or initial projects are likely to be price takers since they are too small to influence market value
- Medium or early projects are likely to arrange long-term power purchase agreements at a slightly lower rate than wholesale market prices in order to mitigate against the risk of market price variation.
- Large projects will have the potential to affect the market value and so market price variation should be considered in the revenue calculation.

III.A.4.3 Revenue Calculation

Revenue may be calculated via several methods depending on the stage of development of the technology.

Rated Power and Capacity Factor Based on the cumulative rated power of the marine energy devices installed at the project multiplied by a load factor to represent the average power output as a fraction of installed capacity. i.e.:

Revenue = Average Power output (kW) x Hours per year x Availability x Av. revenue per kWh

This approach neglects site specific conditions so is only appropriate if assessing an early stage concept.

Occurrence plot and performance surface Based on the performance curve of a typical device e.g. Power(Variable), the cumulative duration of Metocean conditions suitable for operation, e.g. Time(Variable), and the mean value of electricity. The duration of conditions Time(Variable) may be expressed as a probability of occurrence, e.g. p(Variable), multiplied by the duration of the period of interest. For tidal stream devices, a 1-D performance curve, Power(U), and 1-D occurrence plot, probability(U),

may be employed. For wave devices a 2-D performance matrix, e.g. $\text{Power}(H_s, T_p)$ and occurrence matrix probability(H_s, T_p) may be employed. i.e. for a wave energy project:

$$\text{Revenue} = \text{Power}(H_s, T_p) \times \text{Time}(H_s, T_p) \times (\text{MarketValue} + \text{Incentives})$$

Further dimensions to the performance curve may be necessary for some technologies (see IIB). This approach is generally applicable but neglects the influence of the electricity market on revenue so should be used as a first estimate only when assessing a project as a commercial investment.

Time-varying performance Based on the accumulated value of the energy during a discrete time interval and the value of the revenue over the same interval. i.e.

$$\text{Revenue} = \text{Sum} [\text{Energy} (t) \times (\text{MarketValue}(t) + \text{Incentives}(t))] \times \text{TimeInterval}$$

This approach should be used for tidal stream projects and either wave or tidal stream projects with large installed capacity.

III.A.5 Risk Assessment

Objective: Identify the conditions under which the economic assessment is valid.

Process: Three aspects of risk assessment should be considered whilst the economic assessment is conducted. These address the uncertainties associated with the quantities and unit values employed to estimate costs, the uncertainties associated with the future value of an investment and the risks associated with the specific project under consideration.

Sections III.A.2 to III.A.4 identify all items of capital expenditures and ongoing expenditures that must be incurred for the marine energy project to attain a specific energy production and availability. The conditions under which these values are valid must be identified and factors which affect the outcome of the economic assessment must be identified. In particular it is essential to identify circumstances under which the outcome of the economic assessment will result in a different investment decision. Factors that could alter the values employed in the capital cost estimate, operating cost estimate or revenue calculation must be identified so that appropriate mitigation can be identified and any incurred costs or reduced revenue considered.

This section of the ‘protocol’ includes brief guidance on methods for determining unit costs, a summary of the discounting method that is typically employed to quantify the general risk associated with an investment (see also Section III.A.6) and provides an overview of risks that are of particular importance for marine energy projects.

III.A.5.1 Risk Associated with the Assessment Process

Unit costs of materials and processes must be identified by a method that is appropriate to the development stage of the technology. The following approaches provide increasing confidence in the stated unit cost:

- A percentage estimate of the total project cost based on comparable projects
- A single value from comparable project - only appropriate for concept evaluation

- Multiple values or an assumed range of values such that a distribution of expected unit costs is determined. If multiple values are employed for each unit costs, the sensitivity of the outcome of the economic assessment to variation of a given input may be assessed using a stochastic model - see EQUIMAR D7.2.1.
- Values obtained from multiple quotations within a competitive market.

III.A.5.2 Risk Associated with an Investment

Several metrics may be employed to quantify the economic viability of a project. Several approaches that may be relevant to investors are summarised in Section 6. Present value methods account for the timing as well as the magnitude of costs and revenues. The basis of these methods is the idea that a lower value - a greater discount - should be placed on cash flows in the future than on those occurring today as there is a risk that future cash flows may not occur. A higher perceived risk attracts a higher discount rate.

Discount Rate The discount rate used in the economic assessment should be defined by the investors based either on the investors overall cost of capital or based on perceived project-specific risks. References detailing the use of discounting methods for marine energy projects are given in (EQUIMAR D7.1, D7.2.1 and D7.2.2).

A single discount rate may be used for all cash flows, or different rates assigned based on the risk of individual cash- flows relative to all stocks. Typical discount rate values suggested for marine energy in the UK are between 8 and 15% with a higher rate applied to less developed technologies to represent the greater uncertainty associated with both design and cost estimation. Cashflow specific discount rates can be defined based on the providing companys risk relative to all stocks using the Capital Asset Pricing model.

Although discounting methods are straightforward to apply, they do not fully capture the risks affecting specific marine energy projects as distinct from any other investment. Project specific risks must also be identified.

III.A.5.3 Project Specific Risk

A structured approach should be employed to identify issues that are not straightforward to quantify at the present stage of development but that may change the outcome of the investment decision.

An approach for assessing project specific risk is:

Identify: Factors, or events, that could either:

- alter the quantity or unit cost of an expenditure item or
- alter the magnitude or value of energy production.

Quantify: The impact of these factors on the measures of economic viability.

Mitigate: Explain measures taken to limit each risk.

After identifying risks, the costs associated with mitigation activities must be included in Sections III.A.2 or III.A.3 as appropriate. Tables III.A.4 to III.A.6 provide a summary of a high-level assessment based on this approach. For example; Table III.A.4 identifies several generic issues that would directly alter the estimated capital cost. For each of these capital cost risks, the effect on other parts of the economic assessment is identified and

Table III.A.4: Factors affecting estimate of Capital Cost, their impact and possible mitigation (EXAMPLE)

Factor	Other impacts	Mitigation
Higher material quantities		
Bed material not as expected	Increased vessel cost, Design modification required	Site survey
Loss or damage during installation		Contingency funds
Longer installation tasks		
Pre-commissioning delays	Increased vessel cost, Delay to revenue	Contingency funds, Accurate forecasting, Experienced contractors
Design modification during construction	Increased devices costs, delays	Contingency for re-design
Specific vessel unavailable	Increased installation cost, delay	Contractual
Higher unit costs of material or activity		
Price change	n/a	Minimise reliance on estimates, Multiple quotes, Experienced contractors, Contract penalties. Account for by increased discount rate in present value calculations
Market fluctuation of material, work and hire costs	n/a	
Inaccurate cost forecast		

methods by which the issue could be avoided or the effect reduced are identified as mitigation. Similarly, Table III.A.6 identifies several generic issues that will directly alter the estimated revenue and for each item, the effect on other parts of the economic assessment is identified and the mitigation measure identified. Tables III.A.4 - III.A.6 are generic examples; risks specific to the technology and site under development should be identified when conducting a project assessment. A value should be assigned to the mitigation required and these costs included in the assessment. Further risks that may affect the outcome of the project assessment should be identified where possible - e.g. Table III.A.7.

III.A.6 Economic Assessment

The purpose of the economic assessment process is to provide summary information that can be used to compare investment in the project under consideration to an alternative project. The outcomes of the assessment must include one or more parameters which summarise economic viability of the project and a schedule of project risk. One or more of the following parameters may be employed as a quantitative measure of economic viability (Section III.A.6.1). Risks must be identified and mitigated in a structured manner (Section III.A.5.3). At all stages of technology development, both quantitative measures of economic viability and risk assessment will inform the investment decision but the emphasis will alter with the stage of technology development (Section III.A.6.2). The value of each parameter, or combination of parameters, that indicates a viable investment and the project

Table III.A.5: Factors affecting estimate of Operating Cost, their impact and possible mitigation (EXAMPLE)

Factor	Other impacts	Mitigation
Increased frequency of maintenance		
Environmental conditions different to expectations	Corrosion, wear, fatigue issues ,increased capital costs	Alternative design or more frequent maintenance
Increased frequency of repair		
Resource characteristics during extreme conditions different to predictions	Expenditure: repair / replacement	I.A
Lower reliability than predicted	Expenditure: repair / replacement	Testing II.A - II.C (developer), Warranty to specification (investor).
Failure of grid connection	Zero energy output	Redundancy / protection equipment
Clash of mooring lines	Reduced energy output, availability	Testing II.A - II.C (developer), Warranty to specification (investor).
Increased maintenance vessel cost		
Higher mobilisation cost	Reduced availability	Contractual, stand-by vessels
Higher vessel day-rate	Reduced availability	Contractual, stand-by vessels
Extra waiting on weather required	Reduced availability	Resource accuracy IA

risks that are acceptable should be specified by the investor.

III.A.6.1 Quantitative parameters

Specific Cost (€/kW) The capital cost of the project divided by the installed capacity of the marine energy devices. A widely used measure for technology comparison but neglects all operating cost and revenue.

Payback Period (time) The payback period is the time it takes for the cumulative revenue from a project to match the initial investment. Readily understandable and offers a crude measure of investment risk (the faster the investment pays back the less ‘risky’). Its limitation is that it does not account for the timing of costs and revenues, the size of the investment nor the overall return. It is commonly used as a screening method prior to the use of more credible methods.

Cost of Electricity (€/kWh) The Cost of Energy (CoE, or levelised cost) calculation aims to capture the lifetime costs of a generator and allocate those costs to the lifetime electrical output with both costs and output discounted to present value. The approach was developed for regulated monopoly utilities to provide a first estimate of the relative costs of plant. Two calculation methods are widely used - an annuitised approach or a cashflow approach - (see Allan et al. 2010). Note that the CoE of high capital cost, low fuel cost technologies such as wave and tidal energy is very sensitive to variations in discount rates. Unit cost of energy is widely used by policy makers to compare different generating options and to identify the need for subsidy

Table III.A.6: Specific risks affecting estimate of Project Revenue with example of Impacts & Mitigation

Factor	Other impacts	Mitigation
Energy production lower than predicted whilst operating		
Resource characteristics during operating conditions different to predictions	Expenditure: modify design for actual site conditions.	Resource Accuracy I.A
Project components do not realise the predicted performance	Expenditure: repair / replacement	Testing II.A - II.C (developer), Warranty to specification (investor).
Inadequate data acquisition monitoring system (difficult to control device)	Expenditure: monitoring systems, alternative control systems	Accuracy of resource measurement during operation as I.A.
Availability lower than expected		
Resource characteristics during extreme conditions different to predictions	Expenditure: repair / replacement	Resource Accuracy I.A
Lower reliability than predicted	Expenditure: repair / replacement	Testing II.A - II.C (developer), Warranty to specification (investor).
Value of generated electricity lower than predicted		
Uncertainty of device power output	Increased market risk	Testing II.A - II.C (developer), Warranty to specification (investor).
Market value per unit changes over the operating period	Reduced revenue	Outwith project and common risk for all projects over same timescale & at comparable location
Incentives (e.g. political)	Reduced revenue	

Table III.A.7: Additional risks to be mitigated (EXAMPLE).

Factor	Other impacts	Mitigation
Marine Growth	Increased loading	Design for high safety factor / redesign
Lead time	Increased costs pre-commissioning	Allow time in installation schedule
Lack of offshore experience	Cost overruns	Contractual
Inaccurate costing	Increased costs	Contractual
Device failure	Additional repair	
Foundation / mooring failure	Loss of generating capacity	
More severe environmental conditions	Increased repair, increased downtime, reduction of output	
Less severe environmental conditions	Reduced output, increase monitoring costs	
Damage by other marine users	Additional repair	
Health & Safety problem		
...		
...		

for developing technologies. However, this parameter is not widely used for investment decisions since the revenue side of the investment decision is neglected. As such, the risks associated with both variation of the value of a unit of electricity and with the scale of the investment are not addressed.

Net Present Value (€) The net present value (NPV) is the sum of all the costs and revenues over the lifetime of the investment discounted to the present day. A project with an NPV greater than zero has a return exceeding the minimum expected rate and would be beneficial to undertake. For a generation project the NPV can be expressed in €/kW installed. As for COE, NPV is very sensitive to the discount rate.

Internal Rate of Return (%) Internal rate of return (IRR) is related to NPV as it is the discount rate at which the NPV is zero, i.e., in which present value of all future expenditures balance the present value of all future revenues. In effect the IRR measures the cost of capital that the project could support and still break even. The project IRR is often compared to a hurdle (minimum) rate which may be the investors cost of capital or a risk-adjusted rate. Care must be taken with IRR as it implicitly assumes that returns can be invested at the same rate and that changes in net cash flows can lead to multiple project IRRs.

Discount Rate Discounting methods such as CoE, NPV and IRR attempt to encapsulate risk but do so in a non-specific way. For example, discount rate is typically the company's weighted average cost of capital which reflects the differing required rates of return for equity (shares) and debt as well as the balance of debt to equity (gearing). This does not fully capture the risks affecting specific projects or technologies particularly for new projects whose risk structure differs from existing activities.

It is common when comparing the CoE of different technologies that the same discount rate is applied across the board (i.e. to all cash flows). However, this implicitly

suggests that the risk profile of (say) a wave energy converter is the same as that of a gas-fired power station. Common sense suggests this is not true since one has a largely predictable cost stream whereas the other is exposed to volatile wholesale gas prices. Specification of discount rates on the basis of exposure to specific risk factors has been suggested as a means of properly levelling the playing field. This involves applying different risk-adjusted discount rates to different cost or revenue streams or classes of streams, e.g. a higher discount rate would be used for cash flow dependent on fuel prices than for long-term fixed value contracts).

Identification of the risk premium for each risk factor is a significant challenge. However, mirroring practice in financial markets, the use of the Capital Asset Pricing Model (CAPM) to translate the required rate of return (i.e. discount rate) to the risk of specific cash flows has also been proposed. A difficulty with this approach is that risk is defined in terms of the correlation between a cash flow and the stock market and so limited data is available for emerging sectors such as marine energy. Assessment of risk-parameters for sectors that are 'similar' to marine energy suggests that no risk adjustment is required. CAPM applied to individual cash-flows may therefore be more appropriate for assessment of marine energy devices.

III.A.6.2 Investment Criteria

The criteria used to identify whether the project is economically viable will differ between investors and will depend on the development stage of the technology. At all stages of technology development both quantitative parameters (Section III.A.6.1) and risk identification & mitigation are important but the relative importance differs. The expected outcomes of an economic assessment are briefly outlined below for three different stages of technology development.

When considering an early stage of technology development (e.g. concept stage) it will be impossible to determine quantitative measures - such as NPV, COE, etc - with a high degree of confidence. The investment criteria will not necessarily be based on commercial viability. A range of qualitative criteria will instead be used to understand the strategic benefit of the project. At this stage, it is therefore important for the economic assessment to identify the risks associated with the project so that these can inform the investment decision.

When considering a developed technology (e.g. prototype stage), a project assessment can be conducted that provides indicative ranges of quantitative measures - such as NPV, COE, etc. Significant risks associated with the project must have been identified and improved designs or costs incurred to address these risks. The investment criteria will be related to commercial viability but this will not be the only consideration.

When considering a technology for commercial deployment, the investment criteria will be based on commercial considerations. The project assessment must therefore demonstrate high confidence in quantitative values - such as NPV, Payback period, etc - and show that all risks that could change the outcome of the economic assessment have been identified and appropriate mitigation applied. For example, commercial investment criteria may include a set of parameters including:

- Profitability for the funder - e.g. NPV calculated with WACC discount rate > 0
- Profitability for the shareholder - e.g. NPV calculated with shareholder discount rate > 0

- Financial profitability - Return on Capital Expenditure > WACC after n years
- Operational profitability - Net profit / Turn over > x% after n years

Figure III.A.4: Schematic indicating the change of emphasis of an economic assessment of a marine energy project with increasing technology development. Values are indicative only. TODO - figure missing

Figure III.A.4 provides a simplified example of the relative importance of risk and a single quantitative measure of economic viability - in this case Net Present Value (NPV) based on the present value of capital cost, operating cost and revenue - for a technology at three different levels of development. A transition is shown from identification of risks and low confidence in quantitative measures at the concept stage to high confidence in quantitative measures with the cost associated with any project risks included in the assessment at the commercial stage.

Extract from the HLP for IIIA

Principles

The economic assessment of a marine energy project should include the following four stages:

1. Capital Cost

- The level of detail and margins should be compatible with the level of development of the device and assumptions clearly stated with indication of the basis for the likely cost and margins assumed.
- The cost components that are included should represent the major fraction of the total capital cost of the project.
- All expenditures prior to project commissioning should be considered including (but not limited to) fabrication, preliminary works, commissioning, deployment and decommissioning .
- Any capital expenditures required to provide the minimum maintenance scenario (as specified to obtain the device availability and power generation assumed in calculation of revenue) should be considered.
- The quantities and unit costs of all included components should be stated.
- The quantities employed should be consistent with those employed in the LCA, see protocol "I.B Environmental Assessment".
- For all unit costs, the confidence in the values used and possible range should be stated to allow identification of high risk costs (see section III.A.5: Risk Assessment)
- Should include the cost of transmission structure from site to shore obtained by an appropriate method.
- The elements associated with capital cost should consider margins reflecting the uncertainties in the information / data used

2. Operating Cost

- The method used to estimate operating costs should:

- Clearly define the planned maintenance activities for the technology;
- Account for all planned and unplanned maintenance activities that are required to provide the availability and device performance employed in the power generation calculation (see Principle 3: Revenue);
- Include all ongoing costs including (but not limited to) insurance, lease and management that must be incurred to provide the availability and device performance employed in the power generation calculation (see Principle 3: Revenue);
- Include costs associated with environmental monitoring activities (see “I.B Environmental Assessment”).

3. Revenue

- The method used to estimate revenue from the marine energy project should be derived from device performance and the value per unit of electricity. Electricity output should be calculated based on:
 - Site metocean conditions according to the criteria specified in “*I.A Resource Assessment*”;
 - Calculations of device output according to the criteria specified in “*II.A Tank Testing*”, “*II.B Sea Trials*” and “*II.C Deployment and Performance Assessment of Multi-Megawatt Device Arrays*”;
 - The generator availability that is obtained by the maintenance strategy considered in “*Principles part 2*”.
- The revenue per unit (€/kWh) is not explicitly stated in the protocol. The user should employ appropriate values to account for:
 - The market value of electricity over the operating life of the technology appropriate to the predictability of power output and site location under consideration;
 - Additional incentives appropriate to the site location under consideration.

4. Risk Assessment should:

- Define the conditions under which the economic assessment is valid;
- Reflect the uncertainties associated with each component of the capital cost and operating cost of the project;
- Reflect the uncertainties associated with each cost element of the capital cost and operating cost of the project;
- Be conducted to a level of accuracy consistent with the development stage of the technologies used;
- Identify factors (or scenarios) that could change the outcome of the economic assessment;
- Reflect the financial structure of the project.

References

- [1] S. Barrett and A. Lewis, “Ireland’s Quarter Scale Wave Energy Test Site,” AGMET Conference, February 2008.
- [2] T. Boehme, J. Taylor, A. Wallace, and J. Bialek, *Matching renewable electricity generation with demand*. University of Edinburgh for the Scottish Executive., 2006. Contract QLC 11/1.
- [3] “Coordinated Action on Ocean Energy.” Accessed April 2009.
- [4] “Certification of Wave and Tidal Energy Converters,” tech. rep., 2005. DNV OSS-312.
- [5] E. Commission, “7th Framework Programme, Cooperation Theme 5: Energy, Work Programme,” tech. rep. C(2007)560.
- [6] “The European Marine Energy Centre.” Accessed April 2009.
- [7] J. Flinn and C. Bittencourt, “Reliability estimation method for wave and tidal energy converters,” in *Proc. of 2nd International Conference on Ocean Energy (ICOE)*, 2008.
- [8] P. Frigaard, J. Kofoed, and M. Rasmussen, “Overtopping Measurements on the Wave Dragon Nissum Bredning Prototype,” The Fourteenth International Offshore and Polar Engineering Conference, 2004.
- [9] M. Hakim, A. Babarit, A. Clément, and N. Jordana, “Project Development of a Wave Energy Test Site in the French Atlantic Coast Design and Testing of the Mooring System for a New Offshore Wave Energy Converter,” 2008.
- [10] N. Harrington and I. Andina-Pendás, “Environmental impact and appraisal - planning consent for the South West of England Wave Hub, J,” *Underwater Technology*, vol. 27, pp. 161–173, June 2008.
- [11] B. Holmes, K. Nielsen, and B. S, “Wave energy development & evaluation protocol,” *7th European Wave & Tidal Energy Conference*, 2007.
- [12] C. Huertas-Olivares, F. Neumann, and A. Sarmento, “Environmental management recommendations for the wave energy Portuguese Pilot Zone,” in *Proceedings of the 7th European Wave and Tidal Energy Conference*, pp. 11–14, 2007.
- [13] J. Marques, Y. Torre-Enciso, P. Ibañez, and J. Villate, “BIMEP - Biscay Marine Energy Platform,” The 2nd International Ocean Energy Conference (ICOE 2008), 2008.

- [14] K. Nielsen, "Development of recommended practices for testing and evaluating ocean energy systems," *International Energy Agency Technical Report, Annex II*, 2002.
- [15] M. Previsic, R. Bedard, and G. Hagerman, "E2I EPRI assessment: Offshore wave energy conversion devices," 2004.
- [16] M. Ruiz, R. Rodríguez, P. Ricci, A. Marón, E. Prieto, D. Fernández, and M. Taboada "The 2nd International Ocean Energy Conference (ICOE 2008), 2008.
- [17] "Us dept. of energy." Accessed April 2009.
- [18] "Wave Hub web site." Accessed April 2009.
- [19] "Waveplam." Accessed April 2009.
- [20] "Wave train." Accessed April 2009.