



**CALIFORNIA
ENERGY COMMISSION**



Energy Research and Development Division

FINAL PROJECT REPORT

Bat Impact Minimization Technology

An Improved Bat Deterrent for the Full Rotor Swept Area of
Any Wind Turbine

Gavin Newsom, Governor
March 2020 | CEC-500-2020-008

PREPARED BY:

Primary Authors:

David Cooper, Thomas Green, Myron Miller, and Erick Rickards

Frontier Wind
100 Four Falls, Suite 215
West Conshohocken, PA 19428

Contract Number: EPC-14-071

PREPARED FOR:

California Energy Commission

David Stoms, Ph.D.

Project Manager

Jonah Steinbuck, Ph.D.

Office Manager

ENERGY GENERATION RESEARCH OFFICE

Laurie ten Hope

Deputy Director

ENERGY RESEARCH AND DEVELOPMENT DIVISION

Drew Bohan

Executive Director

DISCLAIMER

This report was prepared as the result of work sponsored by the California Energy Commission. It does not necessarily represent the views of the Energy Commission, its employees or the State of California. The Energy Commission, the State of California, its employees, contractors and subcontractors make no warranty, express or implied, and assume no legal liability for the information in this report; nor does any party represent that the uses of this information will not infringe upon privately owned rights. This report has not been approved or disapproved by the California Energy Commission nor has the California Energy Commission passed upon the accuracy or adequacy of the information in this report.

FEDERAL GOVERNMENT DISCLAIMER

This material is based upon work supported in part by co-funding from the U.S. Department of Energy, Office of Energy Efficiency and Renewable Energy (EERE), under the Wind Energy Technologies Office Award Number DE-EE0007034.

This report was prepared as an account of work sponsored by an agency of the United States Government. Neither the United States Government nor any agency thereof, nor any of their employees, makes any warranty, express or implied, or assumes any legal liability or responsibility for the accuracy, completeness, or usefulness of any information, apparatus, product, or process disclosed, or represents that its use would not infringe privately owned rights. Reference herein to any specific commercial product, process, or service by trade name, trademark, manufacturer, or otherwise does not necessarily constitute or imply its endorsement, recommendation, or favoring by the United States Government or any agency thereof. The views and opinions of authors expressed herein do not necessarily state or reflect those of the United States Government or any agency thereof.

ACKNOWLEDGEMENTS

Special thanks to Pattern Energy for enabling the project to have a site to field test the StrikeFree™ bat deterrent system. With limited sites ready to facilitate projects like these because of the inconvenience or risk or both, their participation was crucial to furthering the case of protecting the environment and furthering the profitability of the wind industry. Rene Braud, with Pattern Energy, has been a champion for the project and protecting bats in general. Her enthusiasm and drive have been crucial in pushing this project forward. The team at the Hatchet Ridge location has been great to work with. They ensured that work was done properly and safely and on multiple occasions lent a helping hand to facilitate Frontier Wind crews to perform the work that they needed to do. They can truly be called friends and enablers of us and the project.

Without the help of the California Energy Commission, there is no way this project would have progressed. Their financial help was crucial and their expertise and organization in managing projects were helpful. David Stoms of the Energy Commission was a pleasure to work with and offered his guidance in managing the project and making adjustments along the way when we ran into challenges.

The Department of Energy has also been helpful in pushing this technology both financially and logistically, enabling good progress to the project. It has also opened up avenues to publicize the technology.

Mr. Harry Halloran of Frontier Wind has showed great enthusiasm and financial commitment to getting the project completed and making this technology a success. Harry has long been a champion of wind energy as demonstrated by his early involvement in wind farms in the Palm Springs area in the 1980s as the technology was just beginning to take off in the modern era. Harry's support brought together many bright minds to create the Frontier Wind staff that put their minds, energy and enthusiasm into various wind turbine technologies. Their dreams were big.

Robert Carter, of Piezo Systems Inc. and then Mide, was instrumental in developing a custom transmitter. His enthusiasm and creativity were exceptional along with his determination to do what it takes and continues to have ideas for even greater improvements to sound pressure levels and efficiency.

Bruce Walker, Ph.D., has a wealth of expertise in sound and was instrumental in checking and improving the sound pressure output of our ultrasonic transmitters. He was a pleasure to work with and willing to push the testing forward to new levels even under difficult circumstances.

Many others were helpful in giving advice and insight into bats and the issues that revolve around designing and testing a technology such as this. Some of them include Joel Thompson and Jeff Gruver of West Inc., Ted Weller of the U. S. Forest Service and Chris Hein with Bat Conservation International. Frontier Wind would like to extend their thanks to all these individuals along with others.

PREFACE

The California Energy Commission's Energy Research and Development Division supports energy research and development programs to spur innovation in energy efficiency, renewable energy and advanced clean generation, energy-related environmental protection, energy transmission and distribution and transportation.

In 2012, the Electric Program Investment Charge (EPIC) was established by the California Public Utilities Commission to fund public investments in research to create and advance new energy solutions, foster regional innovation and bring ideas from the lab to the marketplace. The California Energy Commission and the state's three largest investor-owned utilities—Pacific Gas and Electric Company, San Diego Gas & Electric Company and Southern California Edison Company—were selected to administer the EPIC funds and advance novel technologies, tools, and strategies that provide benefits to their electric ratepayers.

The Energy Commission is committed to ensuring public participation in its research and development programs that promote greater reliability, lower costs, and increase safety for the California electric ratepayer and include:

- Providing societal benefits.
- Reducing greenhouse gas emission in the electricity sector at the lowest possible cost.
- Supporting California's loading order to meet energy needs first with energy efficiency and demand response, next with renewable energy (distributed generation and utility scale), and finally with clean, conventional electricity supply.
- Supporting low-emission vehicles and transportation.
- Providing economic development.
- Using ratepayer funds efficiently.

Bat Impact Minimization Technology is the final report for the Rotor-Mounted Bat Impact Deterrence System Design and Testing project (Contract Number EPC-14-071) conducted by Frontier Wind. The information from this project contributes to the Energy Research and Development Division's EPIC Program.

For more information about the Energy Research and Development Division, please visit the [Energy Commission's research website](http://www.energy.ca.gov/research/) (www.energy.ca.gov/research/) or contact the Energy Commission at 916-327-1551.

ABSTRACT

The growth in the number of wind turbine generators has led to a significant number of fatal interactions with bat species. The need to reduce the number of bat fatalities while minimizing power losses is the greatest conservation challenge for wind energy development in parts of the country, according to the American Wind Wildlife Institute. Technological solutions that can also allow turbines to operate normally would generate the maximum electricity and avoid financial losses. Bats use echolocation to perceive their surroundings by listening to features of echoes from their high frequency vocal signals reflecting from targets. In this project, Frontier Wind built on previous research demonstrating that ultrasonic noise can mask echolocation and act as a repellent or deterrent to bat flight activity. Whereas the initial study only broadcast ultrasonic transmissions from the center of the turbine, the Strike Free™ system developed for this project extended the ultrasonic coverage to the entire area swept by the turbine blades. Frontier Wind designed the system components and their integration and then tested them in the lab and in the field at Pattern Energy's Hatchet Ridge Wind Facility near Redding, California. The researchers used an acoustic model to determine the optimal configuration of transmitters along the blades to provide sound transmission coverage across the turbine rotor swept area volume. The custom ultrasonic transmitters were designed specifically for the echolocation frequencies of the four main bat species that have been shown to have died at Hatchet Ridge, although the transmitters can be customized for different frequencies as needed in other geographic locations. The Strike Free™ system shows promise for reducing bat fatalities, and the path to commercialization requires further testing to validate and optimize performance in the field.

Keywords: *Bats, Ultrasonic, Echolocation, Transmitters, Wind Turbine, Blade Mounted, Total Rotor Coverage*

Please use the following citation for this report:

Cooper, David, Thomas Green, Myron Miller, and Erick Rickards. (Frontier Wind). 2020. *Bat Impact Minimization Technology*. California Energy Commission. Publication Number: CEC-500-2020-008.

TABLE OF CONTENTS

	Page
ACKNOWLEDGEMENTS.....	iii
PREFACE	iv
ABSTRACT	v
EXECUTIVE SUMMARY	1
Background.....	1
Project Purpose	1
Project Approach.....	2
Project Results	3
Technology Transfer.....	4
Benefits to California	5
CHAPTER 1: Introduction	7
Background: State of the Science on Wind-Bat Interactions and Mitigation	8
Project Objectives	10
Project Approach.....	11
CHAPTER 2: Site Characterization and System Specification.....	12
Site Characterization.....	12
Bat Characteristics at Hatchet Ridge	13
Bat Fatality Sampling Design and Surveys.....	14
Strike-Free™ System Specification	17
Ultrasonic Transmitters	18
Wire Harness	18
Controller/Amplifier	18
CHAPTER 3: Design and Lab Test of the Strike-Free™ System	20
Acoustic Coverage Model Development.....	20
Control Algorithm Development.....	20
System Design and Test Blade Integration.....	21
Power Supply	21
Amplifier	22
Signal Generators.....	22

Controller.....	22
Transmitters	22
Health Monitoring, Data Collection, and Logging.....	23
Integrated Components Lab Test Results	23
CHAPTER 4: Assemble and Install of the Strike-Free™ System.....	24
Installing and Commissioning.....	24
CHAPTER 5: Strike-Free™ System Field Test and Bat Fatality Surveys	26
Acoustic Performance Testing	26
Static Test Results	26
Dynamic Test Results	27
Preliminary Bat Fatality Survey.....	28
Field Setbacks.....	29
Controllers	29
Power Supply	31
Design Improvements	32
CHAPTER 6: Technology/Knowledge Transfer Activities	34
CHAPTER 7: Conclusions/Recommendations	36
Conclusions.....	36
Engineering Conclusions	36
Biological Conclusions	37
Recommendations.....	37
CHAPTER 8: Benefits to Ratepayers	39
GLOSSARY AND ACRONYMS	40
REFERENCES	41
APPENDIX A: Strike-Free™ System Requirements Specification.....	A-1

LIST OF FIGURES

	Page
Figure 1: System Wind Turbine Swept Area	10
Figure 2: Photo of Hatchet Ridge Wind Facility.....	13

Figure 3: Representation of Statistical Power to Detect a Treatment Effect of 25% or 50% Based on the Number of Years of Study	16
Figure 4: Overall Strike-Free™ System Block Diagram	21
Figure 5: Sound Pressure Level Output From Transmitter T2-1	23
Figure 6: Configuration of Strike-Free™ System Transmitters on a Single Blade	25
Figure 7: Completed Blade Installation of Strike-Free™ System.....	25
Figure 8: Field Measured Spectrogram, Static Test.....	27
Figure 9: Predicted vs Measured Doppler Effect	28

LIST OF TABLES

	Page
Table A-1: Strike Free™ System Requirements.....	A-1
Table A-2: Strike Free™ Electrical System Requirements (if physical hardware is required)	A-1
Table A-3: Strike Free™ Mechanical Requirements (if physical hardware is required)	A-2
Table A-4: Strike Free™ Environmental Requirements (if physical hardware is required)	A-2
Table A-5: Strike Free™ Reliability Requirements (if physical hardware is required)...	A-2
Table A-6: Strike Free™ Certification Requirements (if physical hardware is required).....	A-2
Table A-7: Strike Free™ System EMC, EMI, Lightning and ESD Compliance	A-3
Table A-8: Strike Free™ System EMC, EMI, Lightning and ESD Compliance – Enclosure	A-3
Table A-9: Strike Free™ System EMC, EMI, Lightning and ESD Compliance – DC Power Inputs	A-4
Table A-10: Strike Free™ System EMC, EMI, Lightning and ESD Compliance – Signal and Data Communication Ports	A-4

EXECUTIVE SUMMARY

Background

Wind energy is an important source of renewable energy to help meet California's low carbon energy goals. Numerous environmental factors can either block new wind energy development or reduce the electricity generation from existing wind energy facilities. One of these constraints is the collision of bats with wind turbines. The American Wind Wildlife Institute calls reducing bat fatalities while minimizing power losses the greatest conservation challenge for wind energy development in parts of the country.

Wildlife agencies sometimes place management requirements on wind operators to minimize the number of bats killed. These requirements typically modify the operation of the wind energy facility, such as shutting the turbines down during periods of heavy bat activity like their seasonal migration. Naturally, wind facilities cannot earn revenue during these shutdown periods, and therefore, protecting bats comes at a financial cost. Replacing the lost electricity requires greater generation capacity, which brings a higher cost of energy to ratepayers.

Recent research and development has focused on technological solutions that could reduce the number of bats killed while maintaining the electricity generation of the wind facilities. These technological approaches attempt to discourage bats from flying through the area swept by the rotor blade so that collisions can be avoided. One promising approach takes advantage of bats' use of echolocation in ultrasonic frequencies for hunting and navigating. Bats send pulses of these frequencies above the range of human hearing and monitor the echoes returning from obstacles or prey. Researchers have found that transmitting signals in the same frequencies that bats use can encourage them to stay away from the source. One challenge in this approach is the sound can only be heard over short distances, whereas the wind turbine blades are many times longer than that effective distance. Installing transmitters to provide ultrasound coverage over the entire length of the blades would bring technological challenges.

Project Purpose

Frontier Wind of Rocklin (Placer County), California, developed and tested a system (the Strike-Free™ system) for transmitting ultrasound waves throughout the rotor swept area of wind turbines to deter bats from entering this area.

Specifically, the team aimed to:

1. Design and build a prototype system to reduce fatal bat collisions with wind turbines.
2. Assess the effectiveness of the installed system in reducing bat deaths at Hatchet Ridge Wind Facility in Shasta County, California.

3. Create processes for installation on operating turbines and new turbines.
4. Create system controller settings tuned for a range of frequencies used by the bat species at Hatchet Ridge.

The project attempted to move the Strike-Free™ technology from early stage research and development to near-ready for commercialization; this progress would position this California-based company as a market leader in manufacturing bat-deterrent systems for the global wind energy industry, both operators and turbine manufacturers. The system could be customized to transmit at the frequencies used by bats at any wind facility.

Project Approach

The project focused on four technical task areas and was closely coordinated with the United States Department of Energy, which cofunded the study. The project was guided by a technical advisory committee, consisting of biologists from state and federal wildlife agencies and the United States Department of Energy grant manager.

Site Characterization and System Specification

The research team's bat experts reviewed pre- and post-construction bat activity studies at the Hatchet Ridge Wind Facility to specify many of the characteristics of the Strike-Free™ bat deterrence system. They also designed the bat fatality survey requirements for estimating the effectiveness of the deterrence system in reducing fatalities.

Design and Lab Test System

The team's engineers designed the Strike-Free™ bat deterrence system and assembled the prototype for testing in their lab. An acoustical expert calculated the number and spacing of transmitters that would meet the specification and then tested the prototype to ensure that the system transmitted the proper frequencies of ultrasound at the required volumes.

Assemble and Install System

After successful testing of the prototype components, the team procured and assembled multiple complete systems and installed them on the turbines on site at the Hatchet Ridge Wind Facility.

Perform System Field Tests and Bat Fatality Surveys

The team tested the operation of the systems, including their acoustic performance, in the field to ensure that the specifications were met. Once the systems were installed and tested, the plan was to operate the system for two bat migration seasons and monitor the number of bats killed at the test turbines and a set of control turbines without the deterrent system. The analysis of those data would evaluate how effective the Strike-Free™ system is in reducing fatalities.

Because of a series of technical and environmental challenges, the researchers were unable to complete testing of the effectiveness of the Strike-Free™ system in reducing the number of bat fatalities within the project period. Consequently, the report describes the biological and engineering accomplishments within the project, as well as the steps remaining to be accomplished as future research.

Project Results

Site Characterization and System Specification

The Hatchet Ridge Wind Facility in Shasta County, California, consists of 44 2.3-megawatt Siemens turbines situated along a ridgeline on Hatchet Mountain. The monitoring following construction of Hatchet Ridge found fatalities among four species of bats: silver-haired bats, hoary bats, Mexican (or Brazilian) free-tailed bats, and big brown bats. Silver-haired and hoary bats are common species in mortality studies at wind energy facilities around the country. Estimated annual bat fatality rates at Hatchet Ridge ranged from 5 to 12 bats per turbine, or 2.23 to 5.22 bats per megawatt. All four of these species produce echolocation in the lower ranges of the ultrasonic spectrum, around 25 kilohertz. Therefore, the research team concluded that the deterrent system should transmit in the 20- to 60-kilohertz range at a level of 65 decibels at 10 meters downwind of the wind turbine rotor. The greatest number of fatalities occurred in August and September. The statisticians on the team calculated that about half of the 44 turbines necessary for the evaluation should be divided equally between those with and without deterrent systems. All turbines included in the study would be monitored for bat fatalities for eight weeks each fall for two seasons, ensuring enough bat deaths could be recorded with and without deterrents to have statistical confidence that the difference was from the deterrent and not just randomness.

Design and Lab Test System

The Strike-Free™ system design consists of three main components: an array of ultrasonic transmitters installed along the blade, a wire harness to transmit electrical signals to those transmitters, and a controller/amplifier to send amplified signals to drive the transmitters. The controller needed to activate the system at night when bats are most active, and during the fall bat migration.

Because the system did not exist, it was necessary to design all the components, manufacture them, and then integrate them. The team tested the prototype system at Frontier Wind's lab to make sure it performed as intended before ordering enough systems and installing them for the field test.

Assemble and Install System

The components, including the controller and power supplies, were tested at Frontier Wind's lab. The research team built 12 complete systems and installed them on the test turbines at Hatchet Ridge in 2016 prior to the bat migration season.

Perform System Field Tests and Bat Fatality Surveys

The deterrence system passed the field acoustic performance testing, producing the desired sound levels and frequencies. However, when the first systems began operating in the evening, the power supplies failed. Frontier Wind investigated many potential solutions to the problem, but nothing completely solved it. The bat fatality surveys proceeded as planned, but because of the frequent and repeated failures of the power supplies, the deterrent systems did not operate long enough to collect statistically meaningful data on bat fatalities.

The team spent most of 2017 investigating the power problem and finally found a solution that worked continuously for months during that fall and winter. The team also used this time to improve the transmitters, some of which had failed because water had infiltrated them.

With these and other design improvements, team members worked to get the new version of the systems installed at Hatchet Ridge in time for the 2018 fall bat migration. However, they encountered several delays, the most significant being many days lost because of heavy smoke from the Carr Fire to the west. It ultimately became obvious that the installation could not be completed in time for the bat surveys to begin. At that point, the work was halted, and the focus turned to documenting the project accomplishments and remaining work to validate the effectiveness of the Strike-Free™ system.

The project developed a complete prototype of the Strike-Free™ system and demonstrated operation of the system in the field. The design included an aerodynamically transparent broadband ultrasonic transmitter that could meet the design specification for sound level and frequencies. It will withstand harsh conditions of environmental and physical forces. The design will also allow the mounting of ultrasonic transmitters and harnesses to the exterior of a wind turbine blade with no structural and aerodynamic impacts on blade performance. Furthermore, the project developed a model to determine optimal ultrasonic transmitter spacing on the blade to ensure the entire area swept by the blades is covered with ultrasound tuned to the frequencies of bats present at a given location.

The main result lacking is verifying that the system can effectively reduce bat fatalities. The initial system did not operate long enough to collect sufficient data, and the revised and improved system could not be installed in time for the final field season. This evaluation must be accomplished at a future time with a new source of funding.

Technology Transfer

Frontier Wind's business plan envisioned marketing the rotor mounted bat deterrent system commercially in North and South America, India, and Europe. Frontier Wind registered a trademark for Strike-Free™, registration number 5087642, on November 22, 2016.

The target audience of the technology transfer activities includes the wind industry, wind turbine original equipment manufacturers, wind turbine owners and operators, wildlife management agencies, energy utilities, researchers, and wind-wildlife stakeholders. Frontier Wind shared information about the Strike-Free™ system with wind industry personnel at conferences and webinars, including the U. S. Department of Energy's Wind Energy Technology Office Project Peer Review in 2017. Market transfer activities included discussions on commercialization of the product and potential partnering with various interested partners. Although this study ended prematurely, and Frontier Wind is no longer able to continue developing and marketing the technology, some of the project partners have expressed interest in pursuing the testing phase and future technology development and commercialization if they can secure additional funding.

Benefits to California

This project made substantial progress in advancing an early stage technological proof of concept for minimizing the deaths of bats at wind energy facilities to a higher readiness level and potential commercialization in the near future. Moreover, the Strike-Free™ system was designed to allow wind turbines to continue operating whenever wind conditions were suitable, without having to shut down when bats were active. The design of the Strike-Free™ system was specified with factors important to potential customers, including:

- Lower the cost of energy.
- Allow certification of the wind turbine (despite the installation of additional hardware).
- Be reliable and maintenance free for 20 years.
- Have minimal susceptibility to lightning.
- Reduce overall noise generation of the wind turbine.
- Have minimal lead time increase in production capacity of the wind turbine at the manufacturing facilities.

Ratepayers would ultimately benefit from these same factors. The Strike-Free™ system must still be evaluated in the field to assess the performance in achieving the primary purpose of protecting bats. A complete cost analysis is still needed as well. Early interest from wind facility operators and others suggests that this technology could create a global market in the wind energy sector.

CHAPTER 1:

Introduction

Wind energy represents a clean, abundant and renewable source of power and is considered an important component of this nation's energy strategy (Ciorcirlan 2008). In 2017, wind energy generated within California totaled 12,858 gigawatt-hours (GWh) or 6.23 percent of the in-state total power generation (Hingtgen 2018). A key issue facing wind energy generation is the potential for negative impacts on wildlife species, including bats. Approximately 650,000 to more than 1,300,000 bats were killed by wind turbine facilities in the US and Canada from 2000-2011 (Arnett et. al. 2013). Developing and testing methods of reducing bat fatalities at operating wind turbines is a key focus of research to date. The National Wind Wildlife Research Plan states:

"In parts of the U.S., the need to substantially reduce bat collision fatalities while minimizing power losses represents the greatest conservation challenge for wind energy development. There is an immediate need for empirically based research to enhance the use of existing impact minimization technologies and strategies and to develop new tools and technologies. Also needed is an increase in our understanding of basic bat biology to understand and mitigate risk, resulting in improved and targeted strategies that better mitigate for that risk" (American Wind Wildlife Institute 2017, page 5).

Current industry approaches to mitigating bat fatalities include curtailment programs, when turbines are shutdown during periods of intense bat activity, and controlled alteration of turbine cut-in speeds, when turbines are operated only at higher wind speeds that bats typically do not fly in (Kunz et al. 2007; Arnett et al. 2011). These approaches limit energy production and potential wind power capacity in areas where economic project development is otherwise feasible. Moreover, wind turbine facilities are active for 20 to 30 years, and unpredictability associated with changing migratory patterns, dynamics of ecosystem changes, and continued expansions in the regulatory protective status of bat species, including threatened and endangered listing, compound these issues.

An alternative approach, explored in this project, is to use technology to discourage or deter bats from entering the collision risk zone of wind turbines. This approach would allow turbines to keep generating electricity and, therefore, revenue while reducing the number of bat fatalities. By developing a potentially more effective deterrent technology and methods to mitigate fatal interaction of bat species with wind turbine facilities, this project will enable progress towards a range of state objectives, including: Senate Bill 32 (SB32), which mandates a 40 percent reduction in greenhouse gas (GHG) emissions by 2030; SB100, which requires 100% clean electricity by 2045; and EO B-55-18, which requires statewide carbon neutrality by 2045.

Background: State of the Science on Wind-Bat Interactions and Mitigation

The median estimate of bat fatalities from wind turbines in the United States is 2.7 bats per megawatt per year, and ranges from zero to nearly 50 (American Wind Wildlife Institute, 2018). Developing and testing methods of reducing bat fatalities at operating wind turbines has been a key focus of research to date. Previous observations suggest that bat fatalities at turbines appeared to occur disproportionately during late summer and early fall and on nights with relatively low wind speeds (Arnett et al. 2005). Based on this, several studies have experimented with intentionally pitching the blades into the wind, which results in no or very low (< 1 revolution per minute) blade rotation. This process, known as “feathering”, is typically done at lower wind speeds and has been shown to effectively reduce bat fatalities (such as Baerwald, et al. 2009, Arnett, et al. 2010, Good, et al. 2012). However, feathering turbines during wind speeds at which turbines would otherwise produce electricity results in lost production and adds increased uncertainty into project finances, electrical grid management and lifespan of turbine components.

Curtailed and controlled alteration of turbine cut-in speeds involve the temporary shut-down of wind turbine operations during otherwise productive periods causing operators to lose production and, hence, revenue. They are also inefficient as they are implemented according to conditions and whether bats are present or not. Replacing the lost power requires grid operators to purchase more expensive electricity, which increases the price to ratepayers. Bat activity is challenging to detect due to bats’ small size and high flight speed. Therefore, curtailment must be performed during lengthy seasonal and dusk until dawn periods when fatal bat impact risks are typically highest.

Previous thermal imaging studies have confirmed that bats are attracted to turbines (Horn et al. 2008). Rather than modifying turbine operation, one promising alternative mitigation strategy is to modify the behavior of the bats by deterring them from flying and foraging near the spinning turbine blades. Research involving acoustic devices to reduce bat fatalities at operating wind turbines has been an area of focus for the wind industry and others since at least 2008 (Horn, et al. 2008). Some of this research demonstrated the ability of ultrasound broadcasts to reduce bat activity. Bats rely largely on echolocation (specifically ultrasonic transmission and echo detection) to hunt and capture insect prey and detect their surroundings. Ultrasonic transmissions appear to interfere with bats echolocation used for hunting and navigating. This interference appears to cause bats to avoid the area covered by the transmissions (Schaub, et al. 2008, Johnson, et al. 2012). It follows, therefore, that if bats can be discouraged from flying near operating wind turbines, a reduction in bat fatalities may be realized.

Several studies have applied high frequency bat deterrence components on wind turbines but were met with significant challenges due to shortcomings in their technology approach. A study at the Maple Ridge Wind Farm in Lowville, New York, tested turbine-mounted, ultrasonic bat deterrents (Horn et al. 2008). The units were

tower mounted units installed on two Vestas 1.65 MW turbines. Researchers used a masking generator to create a continuous waveform of random pulse sequences and frequencies. Three emitters were placed around the tower at two heights, which produced two horizontal, doughnut-shaped avoidance zones around the tower. These systems resulted in a statistically significant reduction in bat occurrences and fatalities. For instance, one ten-night test showed up to a 46 percent reduction in bats observed at the turbines with ultrasonic deterrents vs. control units. However, the Maple Ridge study recognized the diminished effectiveness of the test system because the acoustic envelope of the deterrents was far smaller than the total rotor-swept area.

In 2009 and 2010, Bat Conservation International implemented a 2-year study to test the effectiveness of an ultrasonic acoustic deterrent for reducing bat fatalities at wind turbines at the Locust Ridge I and II Wind Farms located in Columbia and Schuylkill Counties, Pennsylvania (Arnett et al. 2013). The study included a randomly selected set of control and treatment turbines and daily carcass searches during summer and fall. Calculated fatality estimates, adjusted for field biases, were compared between the two sets of turbines. Results from this research suggested reductions (up to 62 percent) in bat fatalities at turbines equipped with the deterrent devices (Arnett et al. 2013), though the authors noted that inherent variation in fatalities at treatment turbines made it difficult to quantify actual reductions from initial results.

Indicative research efforts have observed the effectiveness of high frequency sound transmission in a limited area of 5 meter (m) diameter (19.6 m² swept area) to a max of 20m (314 m² swept area) to deter bat activity. The state-of-the-art ultrasonic bat deterrence systems fielded to-date involved wind turbine deployment of transmitters in the nacelle or tower. This is inadequate given the deployment of wind turbine from the leading manufactures with 100m (7,853 m² swept area) up to 130m (13,273 m² swept area) rotor diameters. Thus, a nacelle mounted system equipped transmitters effective for a 20m maximum, can only deter bats in ~4 percent of the swept are for a 100m rotor or just 2 percent of the swept area for the most advanced land-based turbines with 130m rotor diameters. This is particularly problematic given that this state-of-the-art approach has no deterrent coverage in the outboard section of each turbine blade, which is the most potentially damaging to bats because it moves the fastest and has the greatest reach.

The effectiveness of ultrasonic deterrents to reduce bat fatalities at wind turbines is dependent upon the ability to broadcast ultrasound to the area of risk for bats. This is challenging for two reasons. First, it remains unclear how bats interact with wind turbines and whether risk is concentrated in a particular area (for example blade tips) or spread across the turbine's rotor swept area. Second, it is challenging to broadcast ultrasound very far, as it attenuates rapidly in the atmosphere, a condition that is exacerbated by humid conditions. The Locust Ridge study experienced humid conditions (nightly average of ~80 percent), and it is believed the deterrents provided inadequate coverage given their sound power and narrow projection. In addition, the deterrents

experienced reliability issues; water leakage caused some of the electronic deterrents to malfunction and not all deterrents were operational at all times during the study period. Arnett et al. (2013) suggest that the study results may represent a conservative estimate of the potential reduction achievable through application of acoustic deterrents. They recommended that future research, development and field studies attempt to optimize both placement and number of devices on each turbine to affect the greatest amount of airspace in the rotor- swept area to estimate potential maximum effectiveness of this tool to reduce bat fatalities.

Project Objectives

The aim of this project was to advance technology capable of reducing impacts of wind turbines on bats and demonstrate the technology's effectiveness. The Strike-Free™ system developed by Frontier Wind involved the innovative use of broadband ultrasonic transmitters arranged in an array that is installed on the blades of a wind turbine (Figure 1).

Figure 1: System Wind Turbine Swept Area

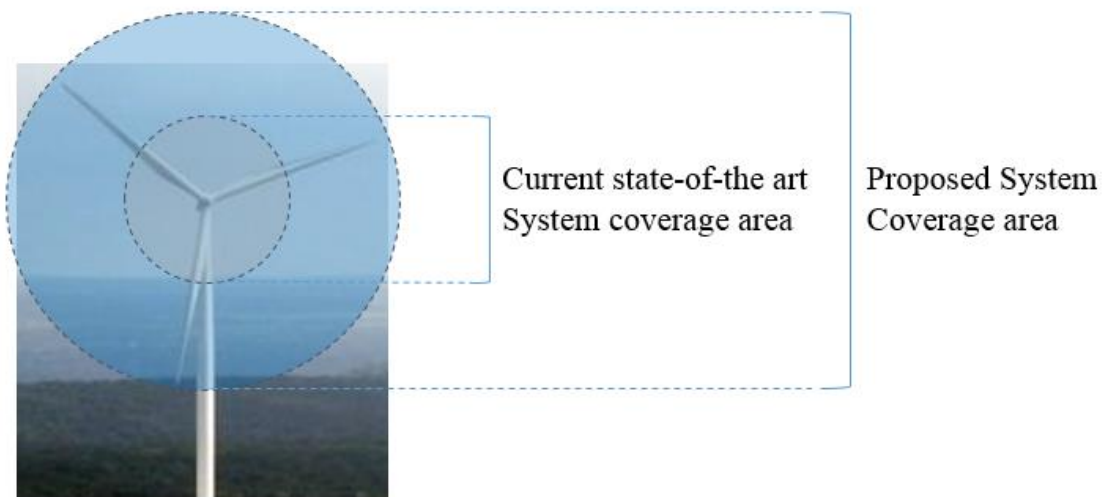

Current State-of-the-art system coverage area vs. proposed project coverage area. The Strike-Free™ System enables ultrasonic transmission that fully encompasses the swept area of the rotating wind turbine blades. The ultrasonic transmitters can project through an area beyond the blade tip, enabling a system that provides acoustic flight deterrent coverage that includes both the rotor area and a buffer zone.

Source: Frontier Wind

The objective of this project was to develop and test a deterrent system for transmitting sound waves throughout the rotor swept area of wind turbines to deter bats from entering this area.

Specifically, the project aimed to:

1. Design and fabricate a system to prevent fatal bat interactions with wind turbines;
2. Assess the effectiveness of the installed system;
3. Create processes for installation on the population of operating turbines and new turbines; and
4. Create system controller settings optimized for a range of bat species.

To demonstrate the effectiveness of the deterrent system in reducing bat fatalities, Frontier Wind partnered with Pattern Energy (Pattern) to allow testing of the deterrent system at Pattern's Hatchet Ridge Wind Facility (HRWF) in Shasta County, California. The project was co-funded by the U.S. Department of Energy (DOE) through Agreement DE-EE0007034.

Project Approach

The project was organized around four technical task areas.

1. Site characterization and system specification
 - a. The goal of this task was to review pre- and post-construction bat activity studies at the HRWF to be used as a key input to the Strike-Free™ system specification of the bat impact deterrence system design process. This task also included designing the bat fatality survey protocol for estimating the effectiveness of the deterrence system in reducing fatalities.
2. Design and lab test system
 - a. The goal of this task was to design the Strike-Free™ bat impact deterrence system, including acoustic design and testing of the prototype.
3. Assemble and install system
 - a. The goal of this task was to procure, customize, assemble system components and install system in HRWF test turbines.
4. Perform system field tests and bat fatality surveys
 - a. The goals of this task included: 1) Operating the system for two bat migration seasons and validating acoustic coverage and 2) Performing bat activity monitoring to validate system performance in reducing fatalities.

The report is organized around these four technical tasks.

Due to a series of technical and environmental challenges, the completion of the field testing of the effectiveness of the Strike-Free™ system in reducing the number of bat fatalities within the timeframe of the project was prevented. Consequently, the report describes the biological and engineering accomplishments within the project as well as the steps remaining to be accomplished as future research.

CHAPTER 2:

Site Characterization and System Specification

To demonstrate the effectiveness of the deterrent system in reducing bat fatalities, Pattern partnered with Frontier Wind to allow testing of the deterrent system at Pattern's HRWF. The Frontier Wind team, as well as subcontractors Western Ecosystems Technology, Inc. (WEST Inc.) and Ted Weller of the U. S. Forest Service reviewed previous pre- and post-construction bat studies conducted at the HRWF. They examined the temporal and spatial patterns of known bat fatalities recorded at the site during carcass monitoring studies to provide recommendations about the timing of the study as well as which specific turbines might warrant specific consideration for this study. They also reviewed the species composition of known bat fatalities recorded at the site to make recommendations regarding acoustic specifications of the deterrent system. Highlights of the HRWF site and bat characteristics at HRWF developed from previous fatality studies are presented next, followed by the bat fatality sampling design and surveys.

Site Characterization

HRWF (Figure 2) is located in Shasta County, California, approximately 40 miles (64 km) northeast of Redding, California. The facility consists of 44 2.3-MW Siemens turbines situated in northwest to southeast orientation along a 6.5 mile (10.5 km) ridgeline on Hatchet Mountain (Tetra Tech 2014).

Elevations on site range from 5,470 feet (1,667 m) in the northwestern portion of the site near a radio tower facility to approximately 4,300 feet (1,310 m) in the southern portion of the site near Hatchet Mountain Pass on State Highway 299. The regional climate is subhumid, featuring warm dry summers and cold moist winters. Average annual precipitation in the area is 50 inches (127 cm), and average annual temperature is 42° F (5.6°C) (Young, et al. 2007).

Sierran mixed conifer is the dominant vegetation community in the area. Structure and composition of this habitat type vary greatly with slope, aspect, elevation, and disturbance, including timber management and wildfire. The site and surrounding areas have been managed as a tree plantation. A forest fire in 1992 led to areas being replanted in white fir and ponderosa pine (Flaig 2015). Dominant overstory species typically include a combination of white fir, incense cedar, sugar pine, ponderosa pine, Douglas-fir, and black oak. Topography on site ranges from relatively flat, on top of the broad ridge, to steep (30-50%), along the side slopes.

Figure 2: Photo of Hatchet Ridge Wind Facility



Hatchet Ridge Wind facility located in Shasta County, California.

Source: Frontier Wind

Bat Characteristics at Hatchet Ridge

Three years of post-construction bat mortality monitoring had been conducted at the HRWF. Standardized carcass searches were conducted continuously from December 12, 2010 to December 12, 2013. The following summary of methods and results is drawn from the comprehensive 3-year monitoring report (Tetra Tech 2014). During the post-construction mortality monitoring study, all 44 turbines at HRWF were searched. Twenty-two of the turbines were searched approximately every two weeks, and the remaining 22 turbines were searched monthly. Carcass removal trials and searcher efficiency trials were conducted to allow counts of carcasses found during scheduled searches to be converted to a standardized estimate of annual fatality rates. Estimated single year bat fatality rates were 5.13 bats/turbine in 2010-2011, 12.02 bats/turbine in 2011-2012 and 9.67 bats/turbine in 2012-2013. On a per megawatt (MW) basis, bat fatality rates were 2.23 bats/MW in 2010-2011, 5.22 bats/MW in 2011-2012 and 4.20 bats/MW in 2012-2013, and according to the report these rates were considered comparable to other wind facilities in the region.

At HRWF, four species of bats were found as fatalities – silver-haired bats (*Lasionycteris noctivagans*), hoary bats (*Lasiurus cinereus*), Mexican (or Brazilian) free-tailed bats (*Tadarida brasiliensis*), and big brown bat (*Eptesicus fuscus*) – along with four unidentified bats. Silver-haired bats were the most commonly found species (n=28), followed by hoary bat (n=20), free-tailed bat (n=14) and big brown bat (n=1). Silver-haired and hoary bats were also among the three most commonly encountered species during mortality studies at multiple wind energy facilities in North America (Arnett and Baerwald 2013). Mexican free-tailed bats were not among the most common species found as fatalities at wind energy facilities (Arnett and Baerwald 2013), although they

are commonly found at facilities within their distributional range, including California (Chatfield et al. 2009) and Oklahoma (Piorkowski and O'Connell 2010).

The four species found as fatalities during the 3-year monitoring study are ones that produce echolocation in the lower ranges of the ultrasonic spectrum, and all use echolocation having a terminal frequency of approximately 25 kilohertz (kHz). Therefore, with regard to the ability of the deterrent system to interfere with the bat's ability to effectively echolocate, noise produced in the 25- to 50-kHz range may provide the greatest benefits.

Consistent with results at most other facilities that have been studied (such as Johnson 2003, Arnett, et al. 2008), bat fatalities were concentrated during the late summer/early fall period, with fatalities reported to have been highest during August and September. Based on figures presented in the 3-year monitoring report, 43 of 67 (64.2 percent) carcasses were collected in August and September. Though the reasons for the strong seasonal signal in fatalities are not fully understood, increased numbers of bats on the landscape (due to young of the year having been added to the population), as well migratory and mating behavior that are common during the fall have been suggested (for example Cryan and Barclay 2009) as proximate reasons for increased fatalities in the fall.

Generally, carcass monitoring studies did not find a particular trend in where bat fatalities are found, either with regard to specific turbines or at the project scale, and there did not appear to be any trend in increased fatalities at any given turbine or section of the HRWF. Turbines on the northwestern end of the string appeared to have a few more plots with multiple bat carcass (3-4) finds over the 3-year period than those on the southeast end, but numbers of found bats were low during each year and cumulatively for the 3-year study, so it is difficult to say if it is the numbers are meaningful. It appears that at least 12 of the turbines had counts of three or four bats found, while the remainder had zero, one or two found during the 3-year study.

Bat Fatality Sampling Design and Surveys

The sampling design at HRWF called for a minimum of half (22) and up to 32 of the 44 turbines. Among the 22-32 turbines selected for the study, the acoustic deterrent would be affixed to half the study turbines and the remaining half would be assigned as control turbines without deterrents. Study turbines were selected randomly from the pool of possible study turbines. Among the considerations that were taken into account when selecting the study turbines were items such as conditions that promote high searcher efficiency (e.g., amount and density of vegetation around turbines) and plot radius constraints (e.g., due to vegetation and/or topography). Perhaps the most important consideration was to maximize the number of carcasses found in the field to improve precision of the estimates (e.g., Korner-Nievergelt, et al. 2011). As a result, researchers would preferentially include turbines in the study where greater number of fatalities had been found in previous years and avoid those where no fatalities had been

found, and treatment and control turbine assignments would be spread as equitably as possible among turbines with the highest recorded fatalities. For example, based on the three years of carcass searching, 12 of 44 turbines had 3 or 4 bat carcasses and 10 of 44 had zero bat carcasses (Tetra Tech 2014). Thus, researchers would randomly assign half of the 12 turbines that had three or four bat carcasses to the treatment group, and the other half would be in the control group. This would continue until all study turbines have been assigned, avoiding those with no previously recorded fatalities if possible.

During each night in the research period, the deterrent treatment turbines would be allowed to operate normally (specifically cut-in and cut-out at manufacturer specifications). However, the deterrent systems would operate from ½ hour before sunset until ½ hour after sunrise, regardless of turbine behavior. The control group turbines would be allowed to operate normally at all times during the study, and would not have deterrent devices.

The response to be measured during the study would be the estimated number of bat fatalities. Fatality rates for the treatment and the control would be estimated to facilitate comparison of total bat fatality rates between deterrent and control. The number of bat fatalities by species would also be estimated if possible to assess if the deterrent is more or less effective for particular species of bats.

The bat fatality surveys were originally to be conducted over an eight-week period in August and September during 2016 and 2017. This time frame overlaps with the fall migration period for bats at HRWF (Young, et al. 2007). This also targets the period when the majority of bat fatalities at wind energy facilities have occurred continent-wide (Johnson 2003, Arnett et al. 2008) and within HRWF. The study would be replicated during 2017; however, results from the first year of study may be used to modify the study design, if needed, in consultation with Frontier, Pattern and the Technical Advisory Committee.

A priori statistical power analysis simulations were created based on existing data from three years of bat mortality monitoring conducted at the HRWF (Tetra Tech 2014). To estimate if bat carcasses collected would be sufficiently numerous for statistical methods to detect a difference between control and deterrent-equipped turbines in the proposed study, WEST Inc. conducted a power analysis simulation based on the following assumptions:

- Twenty-two to 32 turbines to be included in the deterrent study, half of which would have deterrents installed, the other half to operate normally
- Baseline fatality estimate of 9 bats/turbine/year, modeled with a Poisson distribution.
- Searches conducted daily
- Searcher efficiency of 0.6, modeled with a binomial distribution

- Carcass removal time exponentially distributed with a mean persistence time of 1.5 days
- Huso fatality estimator (Huso 2010)

Searcher efficiency is the fraction of carcasses actually detected by a searcher to the true number. This number can be affected by the size and coloring of the species and, the vegetation that may obscure the carcasses. Carcass removal time is the length of time before a scavenger eats or moves the carcass so that it can no longer be detected.

During the simulation, WEST Inc. estimated the statistical power required to detect differences due to the deterrent of either 25 percent or 50 percent (Figure 3). Based on results from a previous deterrent study (Arnett et al. 2013), a 50 percent reduction in fatalities seemed like a reasonable approximation of what the Frontier deterrent system can be expected to produce.

Figure 3: Representation of Statistical Power to Detect a Treatment Effect of 25% or 50% Based on the Number of Years of Study

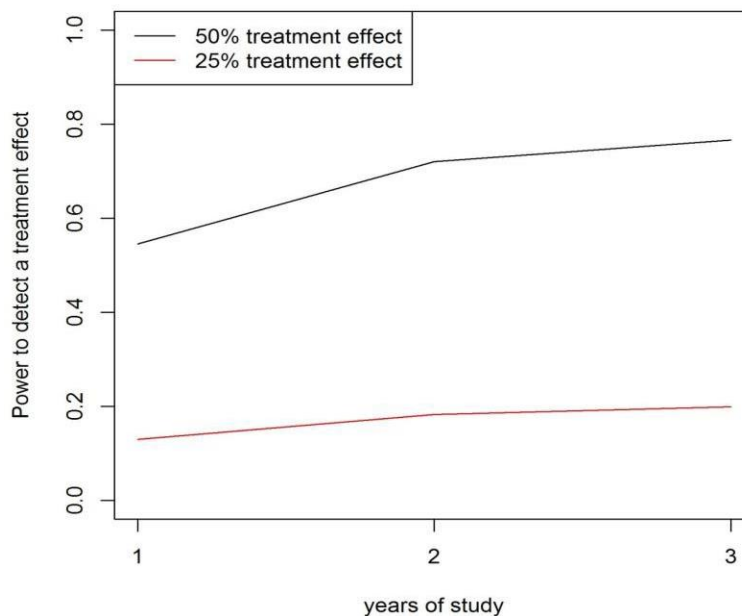

A larger sample size (corresponding to more years of data collection) increases the statistical power of the results to detect an effect of the treatment, in this case that the Strike-Free™ system reduced bat fatalities. The power is greater to detect a large (50 percent) effect than a small (25 percent) effect. In this simulation, not much power would be gained by adding a third year of bat fatality survey data.

Source: WEST, Inc.

As shown in Figure 3, if the treatment effect is 25 percent (specifically 25 percent reduction in bat fatalities at deterrent turbines compared to control turbines) there is very little statistical power to detect the treatment effect, and multiple years of study do little to improve the power. Baseline fatality is likely too low to detect an effect of that

size, given the process variance involved in carcass arrival, carcass removal, and searcher efficiency. If the treatment effect is approximately 50 percent as observed in Arnett et al. (2013) there is power of about 0.55 after one year of study, 0.72 after two years of study, and 0.77 after three years of study. As such, a 2-year study would be most efficacious. While the authors believe that this simulation represents their best estimate of power to detect differences, based on the assumptions made, it may still be conservative if daily searches and increased searcher efficiency yield a larger number of bats in hand than the simulation suggests based on previous data, and/or if the Frontier deterrent system is more effective than previous systems (i.e., > 50 percent reduction in fatalities).

The fatality study would consist of three primary components: (1) standardized carcass searches, (2) searcher efficiency trials, and (3) carcass removal trials. Bat fatality monitoring will be conducted at a minimum of 22 or a maximum of 32 (50 percent and 73 percent of the 44 total turbines in the project, respectively) turbines, half of which will operate normally with deterrents installed and the other half to operate normally with no deterrents installed.

Search plots will be square and extend a minimum of 40 m (131 ft) from the turbine in all directions, but may be irregular in shape due to site specific conditions. The distance was chosen to maximize carcasses found while minimizing the effects of tall vegetation and searching in areas unlikely to provide useful data, and with consideration of available funding. This search plot size is supported by several other studies that have indicated that the majority of bat carcasses typically fall within 100 ft (30 m) of the turbine or within 50 percent of the maximum height of the turbine (Kerns and Kerlinger 2004; Arnett et al. 2005; Young et al. 2009; Jain et al. 2007; Piorkowski and O'Connell 2010; USFWS 2010). Based on data from other carcass monitoring studies, bats are generally found closer to turbines than are birds. For example, at the Dillon Wind Project in Riverside County, California, 80.9 percent of bat carcasses were found within 40 m (131 ft) of the turbine, whereas the most common distance birds were found from turbines was 90 m (295 ft; Chatfield et al. 2009). Because areas near turbines typically incorporate roads, pads, and cleared areas, searcher efficiency is generally higher closer to turbines than farther from them. As such, this approach targets the areas shown to support the highest searcher efficiency while greatly reducing the financial and logistical hurdles associated with clearing and searching large study plots, enabling a more cost-effective study while providing data adequate to meet the study goals. A search area correction will be applied for areas that are unsearchable within 40 m search plots.

Strike-Free™ System Specification

The Strike-Free™ system specification was informed by site specific bat fatality information, bat species activity at HRWF, the related frequency spectrum used by these species for echolocation, and criteria identified as important to the Strike-Free™ customer:

- Lower the cost of energy.
- Allow certification of the wind turbine.
- Be reliable and maintenance free for 20 years.
- Have minimal susceptibility to lightning.
- Reduce overall noise generation of the wind turbine; if this is not possible only allow an increase in the noise by a maximum of 1 dBA.
- Have minimal lead time increase in production capacity of the wind turbine at their manufacturing facilities.

Based on this information, the design team developed the bat deterrence system specifications. The Strike-Free™ system design consists of three main components: an array of ultrasonic transmitters installed along the blade span, a wire harness to transmit electrical signals to those transmitters, and a controller/amplifier to send amplified signals to drive the transmitters. The approach is summarized here, and the full specification is provided in Appendix A.

Ultrasonic Transmitters

The success criterion of acoustic performance for the ultrasonic transmitters was 80 percent coverage of the frequency range between 20 kHz and 60 kHz at a sound pressure level (SPL) of 65 dB at 10 meters downwind of the wind turbine rotor disk.

Wire Harness

The wire harness is a flat ribbon cable where independent pairs are routed to each transmitter. This design has no splices along the length of the blade for reliability purposes. The ribbon cable will mount to the airfoil surface with a tape similar to leading edge protection tape commonly used on wind turbine blades. The tape will allow for quick and simple installation without the need to drill mounting holes in the blade. Leading edge tape has a proven history for reliability on wind turbine blades and since no erosion occurs near the trailing edge, the tape will even have a longer life installed in this location. In addition, the tape will give the wire harness additional protection from ultraviolet light and extend the life of the wire insulation. Blade stretch and contraction occurs due to blade bending and thermal expansion. The wire harness will be mounted on the trailing edge of the airfoil where stretch and contraction is minimized, since it is near the neutral bending axis of the blade structure. For aerodynamic performance, the wire harness will be installed on the flat back trailing edge of the airfoil. As the harness is installed towards the tip of the airfoil, the flat back trailing edge will taper to a near sharp trailing edge; at that point the wire harness will be installed near the trailing edge of the high pressure side of the airfoil.

Controller/Amplifier

The Control System is responsible for the signal generation and amplification of the Strike-Free™ system. The system requires at a minimum the ability to maintain the

correct time at the installed location either via a network time controller or Global Positioning System time signal. In addition to control and amplification, the control system shall be updateable and report system health. The control system shall run and interface with Frontier Wind's controller that activates the system at different times of day, and is capable of operating at different times of the year. Specifically, the controller would activate the transmitters from 1/2 hour before sunset until 1/2 hour after sunrise during the fall bat migration system for the purposes of this prototype demonstration. Based on past experience with Frontier Wind's other products, a real-time Linux-based operating system is the preferred basis. This allows an interface and control that can be written in the C++ programming language. The C++ code could be embedded into the code for the system controller.

CHAPTER 3:

Design and Lab Test of the Strike-Free™ System

The initial activity of the design process was the selection of key system components, including ultrasonic transmitters based on the site characterization and specification inputs detailed in Chapter 2. Acoustic models were developed to determine the required quantity and optimal array orientation to meet the acoustic requirements. Control algorithms were developed to customize the system to the test turbine. Upon procurement of the ultrasonic transmitters, a test panel that was representative of a wind turbine blade section was built to house the transmitters and associated wire harness and controller. The system was assessed as installed in the test section to validate the acoustic models. Details of the acoustic model and control algorithm development, the system design and integrated components test, and final system design follow.

Acoustic Coverage Model Development

2D and 3D acoustic models were developed by Frontier Wind engineers in conjunction with Dr. Bruce Walker to determine the required quantity and array spacing of the transmitters to meet the acoustic requirements outlined in the system specifications. The acoustic model uses as inputs the performance of the audio components and the wind turbine blade design/dimensions. The first candidate ultrasonic transmitter was measured for on-axis and off-axis properties. These measurements were fed into the acoustic coverage model to predict spacing requirements. The transmitters were connected to the development wire harness and controller. The ultrasonic system was assembled in the Frontier Wind system integration laboratory. Dr. Walker assessed the integrated system and validated the acoustic models. Using a microphone capable of detecting ultrasonic frequencies, tests were conducted both indoors and outdoors, Dr. Walker then verified the frequency and sound pressure level coverage predicted by the acoustic models.

Control Algorithm Development

Control algorithms were developed based on system performance and acoustic coverage. System supervisory control was established to enable the system during periods of bat activity, and disable the system when there is little or no bat activity. This required the incorporation of a real-time clock that the system derives its time and date values from. Testing showed that there was minimal drift in the real-time clock as compared to time servers, even after a period of several months, certainly less than the 30-minute window allowed prior to sunset, and after sunrise. Testing and discussions with biologists highlighted that frequency modulation and multiple signal generators

may be beneficial for the system, yielding greater flexibility in control of the system while simultaneously maximizing the frequency spectrum being covered at any given time. To that end, eight signal generator units were incorporated into the field design.

System Design and Test Blade Integration

Development and assembly of the Strike-Free™ system occurred as a modular process. The system was broken down into sub-systems and later integrated as a complete system. The sub-systems identified are the following: Power supply, amplifier, signal generator, controller, transmitters, health monitoring, data logging, and data collection. Figure 4 shows an overall block diagram for the system. Sub-system specifications are summarized here.

Figure 4: Overall Strike-Free™ System Block Diagram

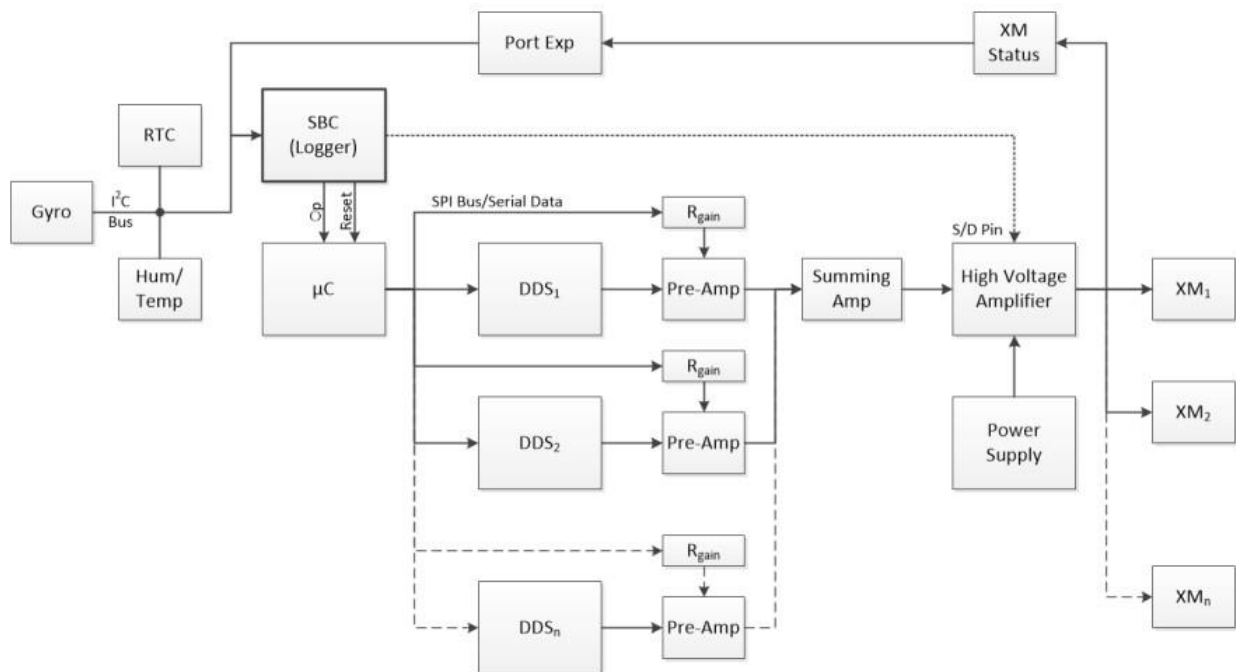

Block diagram for Strike-Free™ system broken down into sub-systems: Power supply, amplifier, signal generator, controller, transmitters, health monitoring, data logging, and data collection. XM = transmitter; DDS = Direct Digital Synthesis signal generator modules; SBC = single board computer for health monitoring, data collection, and logging functions; and RTC= Real-time clock.

Source: Frontier Wind

Power Supply

Power supplies were configured in a bipolar arrangement in order to provide the two potentials, +48 VDC and -48 VDC, for both rails of the amplifier. Each power supply provides 48 VDC; when combined, they supply 96 VDC to the system in each blade.

Amplifier

Two amplifiers were configured in a push-pull (bridge) arrangement in order to increase the power output to the system and to achieve the required sound pressure levels by the transmitters. Each amplifier provides 80 volts peak, yielding a peak to peak output of 160 volts.

Signal Generators

The Strike-Free™ system employs eight Direct Digital Synthesis (DDS) signal generator modules. By using eight signal generators, the system is capable of sweeping through the targeted frequency range eight times per time interval, rather than once per time interval. This has the effect of maximizing the output at all frequencies and reducing the gaps in time where frequencies are broadcast. Equalization is included as an additional feature to boost the output of selected frequencies due to weaker mechanical resonances or atmospheric absorption or both.

Controller

The controller for the system, based on an Atmel ATmega 2560 microcontroller, functions as the equalizer as well as the driver behind the DDS modules. The gain for each of the equalization amplifiers is controlled via the Serial Peripheral Interface (SPI) bus, while the frequencies for each DDS module are controlled via a similar serial interface. The operation of the controller is enabled or disabled by the data logger module at specified times by means of an enable pin.

The main electronic components for the signal generation, control, and data logging modules were initially set up on solderless breadboards using through-hole components for ease of testing. Prototypes and production units installed in turbines have these components integrated into printed circuit board assemblies (PCBAs), which are installed in IP65-rated enclosures for environmental protection.

Transmitters

As designed, the system is comprised by an array of transmitters distributed along the blade. Initial testing showed that transmitters would be arranged at 8 m intervals near the root of the blade, with smaller separations near the tip of the blade. These intervals can be modified to balance frequency output and sound pressure levels along the blade, adding or removing transmitters where necessary to accomplish the specified targets.

Subsequent to the initial candidate transmitter testing, it was decided that future versions of the transmitter should have more pointed frequency output. A second generation prototype transmitter (T2-1) was designed and built with resonances at 35 kHz and 45 kHz in a configuration that was named 'dual-well' after its two recesses where the piezo material and geometry was tuned to output the desired frequencies.

Health Monitoring, Data Collection, and Logging

The health monitoring, data collection, and logging functions are handled by a single board computer utilizing communication over its I²C and SPI busses. The system collects data from a gyro sensor to determine turbine operation by monitoring its rotor speed. In addition, it collects data from board-mounted humidity and temperature sensors to potentially make modifications to transmitter output based on atmospheric conditions. System efficacy may be correlated with humidity and temperature data by analyzing data logs along with the results of bat carcass searches. Health of the system is determined by monitoring each of the transmitter circuits for functionality as well as controller operation. All information is logged and stored locally on non-volatile memory for future collection. In the event of a system malfunction or failure, status light emitting diode visible from the ground will indicate the proper functioning of the system. A later version employed a cellular phone link to permit remote monitoring.

Integrated Components Lab Test Results

After integrating the components above, testing was conducted in the lab environment, as well as outdoors in a parking lot. Lab testing verified the ability of each of the system components to function as intended. The exception was the second generation prototype transmitter. While the transmitter had resonances exactly as designed, and showed marked improvement in SPL output at the 45 kHz frequency range as compared to the initial prototype, the output below 25 kHz, and above 50 kHz were not as strong as was hoped. Characteristic of a mechanical system with a dominant first mode resonance, the output at 35, and 45 kHz is very sharp, as shown in Figure 5.

Figure 5: Sound Pressure Level Output From Transmitter T2-1

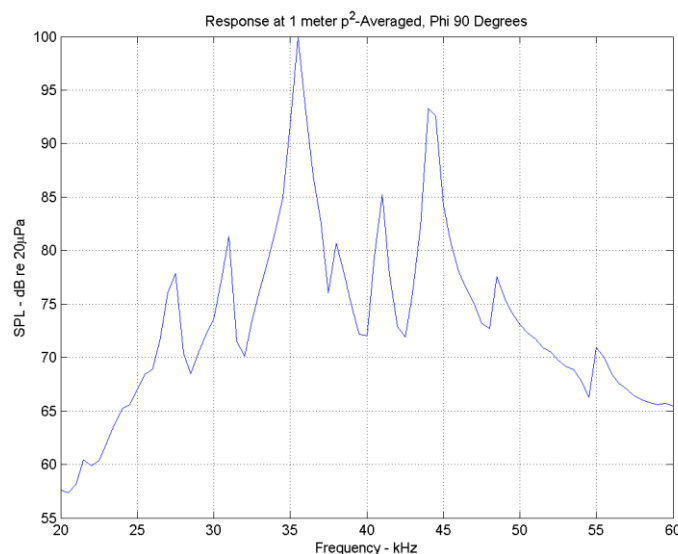

Sound pressure level output from transmitter T2-1. Transmitter T2-1 performs well near its design frequencies, but it struggles in the low and high frequency regions of the target spectrum.

Source: Frontier Wind

CHAPTER 4:

Assembly and Installation of Strike-Free™ System

After completing the final system design the assembly process of the bat deterrent systems began and each system was tested at the Frontier Wind facility. Field installation was completed on 12 wind turbines at the HRWF in 2016 with the first generation dual-well transmitters.

Installing and Commissioning

In collaboration with Pattern Energy, Frontier Wind used a third party wind turbine service company to install the internal and external wire harnesses in each turbine. As a result of the late arrival of power supply shipments for the controllers, the controllers were assembled last. Frontier Wind installed the transmitters and external wire harnesses to the wind turbine blades first, then installed the first system controller internal to the wind turbine (Figures 6-7).

Frontier Wind provided training and cable installation procedures for the service company personal to successfully complete the install. The procedures were written to aid the installation team to properly install the wire harness on the blades. In addition, the team was trained in the installation process on the ground on sample boards to simulate the blade before work was done on actual blades in the man basket.

The test systems were commissioned and checked for system functionality by running a pre-defined test sequence. After commissioning, the system logs its activity to an onboard data memory card. Frontier Wind ordered enough transmitters for thirteen wind turbines and one additional blade for spares. However, to properly test a system at Frontier Wind's facility, a full turbine set of transmitters was needed to fully load the power supplies. Later, it was determined that a full turbine set was necessary in the lab for testing at all times for the full duration of the study.

Figure 6: Configuration of Strike-Free™ System Transmitters on a Single Blade

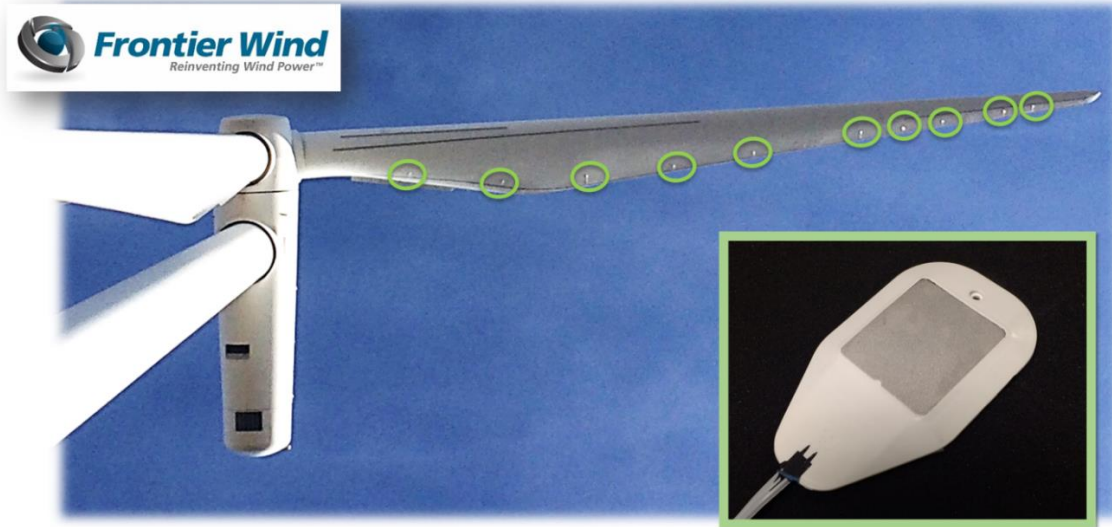

Configuration of Strike-Free™ System Transmitters on a signal blade based on design specification. Lower right corner: Piezo transmitter with aerodynamic fairing (housing).

Source: Frontier Wind

Figure 7: Completed Blade Installation of Strike-Free™ System



Installed Strike-Free™ system on wind turbine blade at HRWF.

Source: Frontier Wind

CHAPTER 5:

Strike-Free™ System Field Test and Bat Fatality Surveys

Acoustic performance testing and a preliminary bat fatality survey were completed on the 12 installed bat deterrent systems at the HRWF. Throughout the field testing period numerous field setbacks were experienced. Details of the field testing and subsequent field setbacks and are summarized in this chapter.

Acoustic Performance Testing

Measurement of the acoustic performance of the initial installed Strike-Free™ was completed in 2016 prior to that year's bat fatality survey. Based on laboratory testing, the success criterion of acoustic performance was 80 percent coverage of the frequency spectrum at an SPL of 65 dB at 10 m. Two sets of measurements were taken, one while the turbine was not rotating, with one blade pointing towards the ground and the yaw system fixed, and one while the turbine was operational. While the turbine was operating, microphones were placed on the upwind side of the tower to observe ultrasonic transmissions at various locations, and to assess the Doppler shift effects on the broadcast signal. Results of the test procedure are summarized below.

Static Test Results

SPLs in the frequency ranges around the four desired resonance peaks of the transmitters was well above the desired 65 dB, with some dips below 65 dB between those peaks. Most of the measurements were taken with the blade pitched such that the transmitters were off axis, and thus the SPLs are lower. The further off axis the measurements are taken, the lower the expected received signal. Only the transmitters on the downward pointing blade were operating for the test; with all three blades operational it would be expected to see higher off axis amplitudes due to signal superposition as each blade passed the microphone.

In the signal generation portion of the controller, eight DDS modules each sweep through the entire 20-60 kHz frequency range, with 5 kHz of separation between them. Each of those signals is amplified individually before all of them are summed and the resulting multiplexed signal is further amplified to drive the transmitters. The gain on the individual DDS signal amplifiers is adjustable via a digital potentiometer. For the purposes of the test, a flat, mid-range gain was used and the value set to prevent clipping of the power amplifier output at resonance. Gain scheduling will be used in future testing to even out the frequency response, i.e., gain will be increased in the frequency regions with lower SPLs.

The spectrogram in Figure 8 shows the eight frequency sweeps generated by the controller. In general, the field measured spectra show that at the primary peaks in the actuator design, levels will exceed requirements of 65 dB at 10 meters.

Figure 8: Field Measured Spectrogram, Static Test

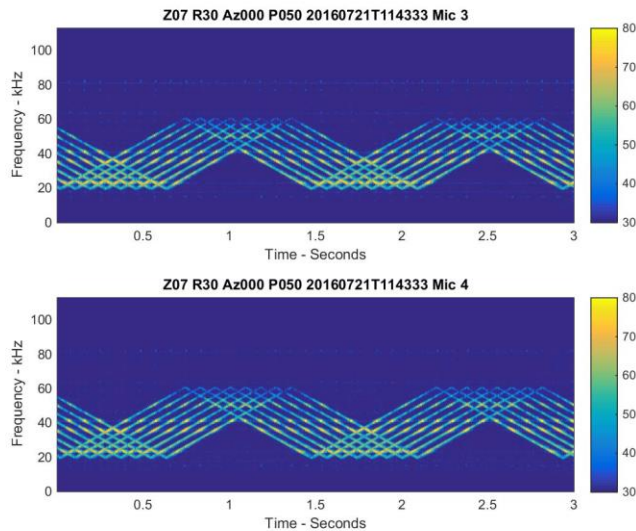

The spectrogram shows all eight frequency sweeps generated by the controller. The field measured spectra show that at the primary peaks in the actuator design, levels will exceed requirements of 65 dB at 10 meters. The two plots represent the data from two different microphones.

Source: Frontier Wind

Dynamic Test Results

This test was performed to investigate the Doppler shift of the transmitted signals due to blade rotation. The prominent resonant peaks in the output spectra collected during dynamic testing were identified and used to calculate the ratio of the observed frequencies to the emitted frequencies and tabulate them versus the time offset from the center of the blade pass. A comparison of the predicted frequency ratios and the measured frequency ratios is shown in Figure 9. The measured values agree very well with the predicted values, with some scatter due to variations in rotor speed and the difficulty of precisely identifying exact times and frequencies of the actuator peaks from spectrogram plots. However, there is a clear indication that computing the Doppler shift based on rotor geometry provides a reliable prediction.

Figure 9: Predicted vs Measured Doppler Effect

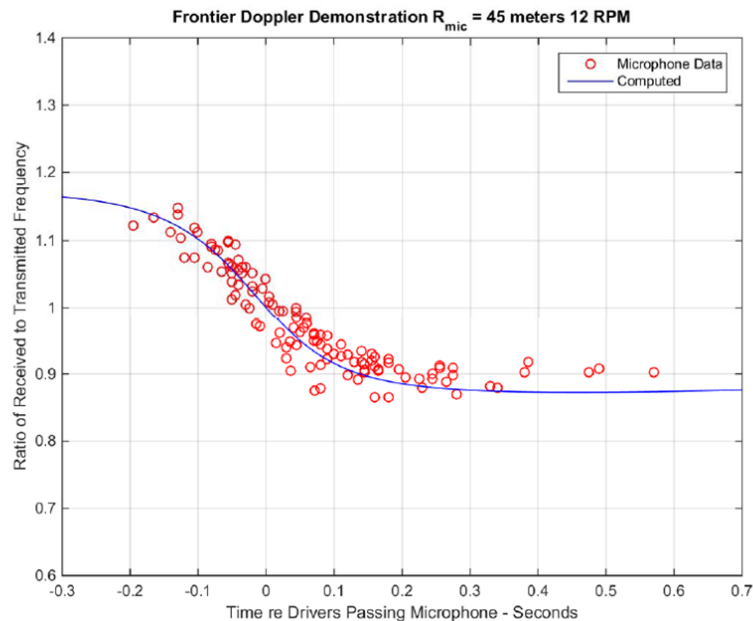

Comparison of the ratios of received to transmitted frequencies showing a close fit between predicted and measured ratios.

Source Frontier Wind

Preliminary Bat Fatality Survey

With the bat deterrence system installed, commissioned, and passing the acoustic performance test, bat fatality monitoring began on August 1, 2016. Fatality monitoring was scheduled to conclude at the end of September, 2016. Due to operational time lost because of controller failures (see below), Frontier Wind extended the fatality monitoring to October 14, 2016.

Following the conclusion of the 2016 bat migration season, a basic analysis of the bat fatality data and operational time data was conducted. Due to the multiple power supply failures, limited useful fatality data was collected during the 2016 bat migration season. Preliminary results of the basic analysis of the 2016 bat fatality study include:

- Total Bat Carcasses Collected
 - (All Species, All 26 Turbines)
 - Total Fatalities Collected: 197
 - Estimated Time of Death < 1 day: 127
- Carcasses Collected at Paired Treated/Control Turbines
 - (All Species, 24 Paired Turbines)
 - Total Fatalities Collected: 162
 - Estimated Time of Death < 1 day: 115

- Bat Fatalities by Species: Silver-haired Bat (53), Mexican Free-Tailed Bat (49), Hoary Bat (32), California Bat (25), Big Brown Bat (3)
- Carcasses Collected During Bat Deterrent Operation
 - Estimated Time of Death < 1 day
 - Total for Control and Treated Turbines: 34
 - Bat Fatalities by Species Control: Silver-haired Bat (4), Mexican Free-Tailed Bat (4), Hoary Bat (2), and California Bat (1).
 - Bat Fatalities by Species Treated: Silver-haired Bat (2), Mexican Free-Tailed Bat (6), Hoary Bat (7), and California Bat (3).

Thus only 34 of the 162 total fatalities at paired treatment/control turbines occurred while the deterrent systems in the treatment turbines were operational. This number is too small to draw any statistical conclusions about the effectiveness of the Strike-Free™ system in reducing bat fatalities. Data are only presented here to give a sense of the numbers of fatalities and the species found. The research team concluded that it would be possible to achieve the desired statistical power by combining the 2016 and 2017 survey data, assuming the technical problems could be resolved.

Field Setbacks

Controllers

The first installed controller checked as anticipated during installation in 2016, and the system was set to run for the first evening. After than less than one hour of operation, the power supplies in the controller failed. A second controller in a second turbine was installed on the same day, and the exact same failure occurred in under one hour of full operational time.

Both of the failed controllers were removed and sent back to Frontier Wind for analysis. It was found that the power supplies had catastrophically failed. The operational temperature was measured at the upper limits of the temperature range of the power supplies due to the increased power required to run quad-transmitters versus the originally planned dual-transmitters. Quad-transmitters were used in order to achieve the desired frequency output. This doubling of the number of piezoelectric transmitters increased the power required to operate. However, the required power was within the capacity of the installed power supplies. To simulate measured temperatures experienced in the wind turbine hub at 34°C, Frontier Wind set up a room in their facility with electric heaters to raise the ambient temperature above 34°C. They could not recreate this failure in the lab; the controllers operated well at elevated temperatures. To solve the temperature issue, Frontier Wind designed and installed cooling fan assemblies on the controllers. Testing showed significant success in reducing the temperature of the controller by 40°C and the power supplies were well within the operation temperature range.

Frontier Wind installed the first fan-cooled controller in a turbine, and successfully tested the system with the turbine not rotating for more than one hour, since all prior failures occurred within one hour of operation. The controller was set for operation that evening and operated without failure in standby mode during the daytime. Transmitter output automatically turned on for the evening and the power supplies experienced the same failure within three minutes of operation, giving the system very little time to heat up. The power supply failure issue proved not to be resolved by reducing operational temperatures.

Frontier Wind contacted the power supply manufacturer and Siemens to discuss possible issues with the power supplies and power quality in the turbine. Since the power supply manufacturer could not replicate the failures in Frontier Wind's lab and failures only occurred in a rotating turbine, the team focused on how a rotating turbine could result in a failure. They speculated that the power quality over the slip ring of the wind turbine was not stable or there could be a mechanical issue with components rotating in the wind turbine hub. Siemens stated that power supplied over the triple redundant slip ring is typically clean; however, one possibility could be that all of the equipment in the hub could be causing surges on the power supplied to the controller. This equipment includes heaters, fans, control equipment, and a UPS. The failed controllers had minimal power line protection installed, but that protection could be significantly improved. Frontier Wind also found that the delay in delivery of the power supplies resulted from the manufacturer having difficulties with the supplies passing their internal quality tests. Frontier Wind attempted to find an alternative power supply manufacturer. However the piezoelectric ultrasonic transmitters require a non-standard voltage of 96VDC at 600 Watts. Multiple power supply manufacturers quoted eight weeks to modify an existing design and manufacture a product with these voltage and power requirements. In addition, the replacement power supply packaging was much larger and would require significant changes to the controller enclosure design to accommodate the size of the replacement power supplies. Eight weeks was determined to be too long to capture the bat migration season for 2016, so Frontier Wind elected to resolve the issue with the current power supplies.

In reviewing the bat deterrent application, Frontier Wind concluded that the power line source inductance was too high. In the controller, there are eight power supply modules. Each power supply module uses a unique Adaptive Cell Topology that dynamically matches the powertrain architecture to the alternating current (AC) line voltage. The module uses a unique control algorithm to reduce the AC line harmonics yet still achieve rapid response to dynamic load conditions presented to it at the direct current output terminals. Given these unique power processing features, the module can expose deficiencies in the AC line source impedance that may result in unstable operation. Given that the bat deterrent system has eight modules, a competing environment was inadvertently set up where one or more modules actively change the input power conditions and the remaining modules try to counteract those changes, resulting in very unstable and dynamic power line conditions, ultimately resulting in

failure. To ensure this condition does not occur, a very low power line source inductance must be maintained. The wind turbines most likely have high power line inductance compared to the lab environment due to the slip ring and transformers installed in them, resulting in more failures onsite compared to the lab.

To resolve this issue, the power supply manufacturer recommended isolating each power supply module from the remaining modules by installing independent rectifiers, capacitors, and over voltage protection on each power supply module. In addition, they recommended installing diodes on the output of each power supply module. Originally, the controller shared one rectifier/capacitor assembly for all eight power supply modules. Each enclosure was modified with seven additional rectifier/capacitor assemblies with output diodes as a result of the recommendations to isolate each module.

Frontier Wind upgraded all controllers with the recommended changes. To ensure maximum operational time in the field, Frontier Wind installed modified controllers in the field as soon as the modified controller completed testing. The initial two installed modified controllers were tested in the field for failures and operated without failure during the entire controller replacement program.

Power Supply

At the end of the 2016 bat migration season, Frontier Wind traveled to the HRWF site and shut down the bat deterrent systems. Power supply failures were discovered on most of the systems, despite the alterations that had been installed. Operational data was retrieved from every controller by removal of the memory card. Investigation into causes for power supply failures in the bat controllers was conducted.

Frontier Wind used power analyzing equipment made by Fluke to measure and monitor the voltage and current at the input to the power supply. The team documented power spikes and correlated them with the time of failure. The evidence pointed to power disturbances due to inductive spikes generated by the inductive solenoids that actuate the hydraulic pitch valves. The team decided that the previous power supply was not working due to the dirty power present on the wind turbine and the level of power needed, so another company that specializes in custom power supply designs that would function well in this environment was utilized. Frontier Wind rewired an enclosure to facilitate testing of the new power supply in conjunction with the controller. Frontier Wind worked with new power supplier to test the new power supply for operation with dirty power using Pacific Power Source instrumentation that can inject dirty power with various power anomalies. The unit passed all dirty power tests.

A new mounting system was designed for the new power supply. The design involved using a large mounting plate that replaced the plate over the hydraulics similar to the one the controller was mounted on. The power supply was then tested in the field but it also failed. Upon investigation it was discovered that the device used to clamp the noise of the dirty power failed. A larger Metal Oxide Varistor was designed and then

put in the field turbine for testing. This design worked. Frontier Wind installed the new improved power supply with a Strike-Free™ controller in turbine H13 at Hatchet Ridge the week of September 11 to 15, 2017. The last onsite check made of the system was on February 16, 2018 and the system was still operational. However, the 2017 bat migration season ending so the bat fatality survey was rescheduled for fall 2018.

Design Improvements

While the power quality problem was being solved, Frontier Wind continued to make design improvements on other components. The first component improvements were with the ultrasonic transmitters. The manufacturer of the transmitters implemented an improved design to address a problem where water got into some of the transmitters. In addition, the transmitter manufacturer produced five samples of three varieties that were improvements to the version 1 transmitter. These were sent to Bruce Walker, the acoustic consultant, who tested all three varieties of the new transmitter and the old one for comparison. He discovered that the new transmitters' output was comparable to the previous transmitter. This allowed for the use two ceramics instead of four to cover the 20KHz to 35KHz spectrum, which would save power while maintaining the same output levels for the range.

The second improvement was for the component monitoring the health of the system. The team worked with the Verizon network to obtain new cellular phone links using Connected IO modem. The SIM cards were ordered and received for the Verizon modem. They integrated the new cellular phone links for the Verizon network into the system with hardware and new software to collect data and report status. A sample prototype with transmitters was manufactured.

The cables internal to the blades and also the ones external to the blades with transmitters were produced and the fabricator stayed ahead of the install crew installing the cables on the turbines. Much of the amplifier PCBA was done in house. The manufacturer of the amplifier was consulted on the final circuit architecture resulting in an inverting and non-inverting high gain configuration for both and using the MP118FD version. Controller boards were tested. Six controllers that include amplifiers were assembled and ready in July, 2018. The assembly includes the amplifier PCBA with its heat sink, the controller PCBA and the enclosure along with the wiring.

By the time the power supply problem was resolved and the new components were designed and being fabricated, there was very little time to deliver and install all the Strike-Free™ systems prior to the 2018 fall bat migration season. Everything needed to go perfectly to be on schedule. Unfortunately, that did not happen. Frontier Wind experienced multiple delays in cable installation, including flight delays, lost luggage with equipment by the airlines, high winds and lightning, and extreme air quality and visibility restrictions because of the Carr Fire. Due to the various delays (most notably the Carr Fire), team managers determined that the project could not be completed in

time. Because of the project end date, it was also not possible to extend the project through the 2019 bat migration season.

CHAPTER 6:

Technology/Knowledge Transfer Activities

Introducing rotor mounted bat deterrent technology to the market could have the broad impact of reducing curtailment activities at wind farms as well as increasing wind farm development rates across the country and globally. Current conservation approaches are limited to curtailment or increasing cut-in speeds. These solutions lead to reduced revenue, grid inefficiencies, and higher energy costs for the consumer. Using Strike-Free™ to provide bat deterrence could allow for reduced bat mortality and greater energy generation at a lower cost. Frontier Wind’s business plan envisioned marketing the rotor mounted bat deterrent system commercially in North and South America, India, and Europe. Frontier Wind registered a trademark for Strike-Free, registration number 5087642, on November 22, 2016.

The project developed the following specific technologies:

1. Ensonification of the entire wind turbine rotor with broadband ultrasonic noise at 65dB at 10m to effectively reduce the number of bat fatalities.
2. The design of an aerodynamically transparent broadband ultrasonic transmitter that will withstand harsh conditions of both environmental and physical forces.
3. A reliable and easy to retrofit design that allows the mounting of ultrasonic transmitters and harnesses to an exterior of a wind turbine blade with no structural and aerodynamic impacts on blade performance.
4. Acoustic attenuation model to determine optimal ultrasonic transmitter position on the blade to ensure the rotor envelope is ensonified.
5. Advanced ultrasonic controller and amplifier design.
6. Ultrasonic system controller settings optimized for a range of bat species.

The long-term objective of the technology transfer plan was to guide how the knowledge gained from the project will be made available to the public, including the targeted market sector and potential outreach to end users. This audience includes the wind industry, wind turbine original equipment manufacturers, wind turbine owners and operators, wildlife management agencies, energy utilities, researchers, and wind-wildlife stakeholders.

Frontier Wind shared information about the rotor mounted bat deterrent system with wind industry personnel at the following events:

- Dec 2, 2015, NWCC Webinar: Bat Detection and Deterrence Technologies, Erick Rickards, <https://www.nationalwind.org/developing-technologies-bat-detection-deterrence-wind-facilities/> along with other DOE bat detection and deterrence projects

- Nov 29, 2016, Wind Wildlife Research Meeting XI, Broomfield, CO – Poster Presentation - Rotor-mounted Bat Impact Deterrence System – Myron Miller, Frontier Wind
<http://programme.exordo.com/wworm2016/delegates/presentation/103/>
- Feb. 24, 2017, Frontier Wind attended the 5th International Berlin Bat Meeting event to network with European customers and to meet with Evergy Engineering GmbH to discuss possible sponsorship of a European fatality study utilizing the rotor mounted bat deterrent system. Evergy originally contacted Frontier Wind as a result of the NWCC webinar given Dec 2, 2015.
- February 2017, Frontier Wind participated in the DOE Wind Energy Technology Office Project Peer Review in Arlington, Virginia. They presented the project (<https://www.energy.gov/sites/prod/files/2017/03/f34/Wind-Market-Acceleration-and-Deployment-031717.pdf>) to nearly 300 representatives from national laboratories, academic institutions, and other stakeholders. Peer review comments can be found at https://www.energy.gov/sites/prod/files/2018/02/f48/Vol_2_RMB_2.pdf
- Feb. 7, 2018 EPIC Symposium, Sacramento – Poster Presentation - Rotor-mounted Bat Impact Deterrence System – David Cooper, Frontier Wind
- March 12, 2018, Frontier Wind participated in a webinar hosted by the National Wind Coordinating Collaborative of DOE bat detection and deterrence projects; David Cooper presented on the Strike-Free™ system. The webinar was viewed by over 100 participants. https://www.nationalwind.org/wp-content/uploads/2013/05/3_NWCC-Webinar_Rickards_Frontier.pdf

Market transfer activities included discussions on multiple occasions on commercialization of the product and potential partnering with various interested partners. Although this particular research study ended prematurely, some of the project partners have expressed interest in pursuing the testing phase and further technology development and commercialization.

CHAPTER 7:

Conclusions/Recommendations

The risk of bat collisions with wind turbines poses a challenge for the wind energy sector. Developers and investors may avoid siting new wind energy facilities where the risk is perceived as too high. Mitigating bat fatalities through curtailment or increasing cut-in speeds reduces revenue and, therefore, reduces the profit margin. Finding a solution that allows the turbines to operate whenever wind conditions are favorable while significantly reducing bat fatalities would be of great benefit to the wind industry globally. The Strike-Free™ system was envisioned as one potential technological solution that used the fundamentals of bat biology and behavior. This research project set out to design and develop a prototype of this system and then evaluate its effectiveness at reducing bat fatalities at one wind energy facility in California. The system was designed and iteratively improved to overcome unanticipated problems. Unfortunately, the delays incurred to solve those problems, as well as additional delays outside the control of the researchers, prevented the completion of the bat testing phase within the timeframe of the project.

Conclusions

Engineering Conclusions

- The research team designed the Strike-Free™ system to the specifications of the bat biologists for the four main species found among fatalities at HRWF.
- The team built, tested, and iteratively improved the components of the system, including overcoming a major, unforeseen problem with the power quality in the nacelle.
- The team obtained permission from the turbine manufacturer to install the transmitters and wiring on the blades of operational turbine blades. This can be a serious obstacle to testing any kind of deterrent system because manufacturers are generally concerned that such additions or intrusions may create structural and aerodynamic impacts that could compromise blade performance.
- The team also obtained a commitment from Pattern Energy, the operator of HRWF, to install and test the Strike-Free™ system on its turbines. Operators are often reluctant to provide facilities, because the installation, commissioning, and testing can force them to shut down turbines temporarily. Pattern Energy was convinced that the potential benefit to the company and the industry outweighed any minor lost revenue.
- Much of the cost of the study was to pay for the installation of the system on the test turbines as a retrofit in the field. This required numerous trips up the towers

in baskets. These costs could be significantly reduced if the system was installed during the blade fabrication.

The project ended before the full set of Strike-Free™ systems were manufactured, shipped, and installed. The remaining systems could be built, assembled, and installed relatively quickly for use in a field test in the future as additional funding becomes available.

Biological Conclusions

- Bat species at HRWF and their frequencies were determined based on existing pre- and post-construction surveys.
- Bat fatality surveys in 2016 was not conclusive regarding the effectiveness of the Strike-Free™ system because of the small sample size caused by technical problems that caused the systems to fail.
- The latest design improvements are likely to be more effective because of their increased SPLs with lower power requirements.
- Although the prototype Strike-Free™ system was customized for the four bat species at HRWF, the tunable transmitters could be adapted to any bat species in the world and hence potentially support a global market.

Recommendations

The authors recommend that the Strike-Free™ system be field tested soon, as it appears to be a promising technology. The concept is sound, and the prototypes have demonstrated a solution.

1. Install and test the latest design through two bat migration seasons according to the sampling plan to determine the effectiveness of the system to reduce bat fatalities by at least 50 percent.
2. If #1 successful, adapt to other species/frequencies and test in other regions.
3. Apply upgrades to transmitters (greater power, better hitting target frequencies), controllers, sensors of current, and communication of system status.
4. Test sound pressure level needed for effective deterrence. A review of previous studies and testing showed that there is not a clear consensus of what a target level should be. The researchers originally assumed 65 dB but later concluded that 55 dB might be enough. This hypothesis needs to be tested systematically to determine the optimal level.
5. Revise the controller board to incorporate more robust lightning protection and current sensing as useful additions.
6. Conduct a formal life cycle cost analysis to estimate the cost of both the retrofit version and the version where the system is installed in the turbine manufacturing stage. In conjunction with the data on bat fatalities from field

surveys, compare the relative costs of the Strike-Free™ system with the cost of curtailment, relative to the benefits of fatalities avoided.

CHAPTER 8:

Benefits to Ratepayers

Wind is an inexpensive, clean source of renewable energy that helps California achieve its ambitious energy and climate goals. Bats provide valuable ecosystem services to humans, including controlling insect populations, pollinating crops, and dispersing seeds. Sometimes the interaction of bats and wind turbines leads to bat fatalities, primarily from collisions with the rotating blades. Wildlife agencies often impose mitigation requirements on wind facility operators to reduce the number of bat fatalities. Conventional mitigation methods usually involve shutting down or curtailing turbines when bats are particularly active at a facility, such as during migration seasons. Curtailment causes a loss of generation and revenue for operators and consequently higher costs to rate payers. Technological solutions such as the Strike Free™ system avoid those financial losses by allowing the turbines to continue operating. The relative costs and benefits of this system still need to be compared with those of curtailment.

In addition to the direct benefits of the project, the Strike-Free™ system offered the potential for long-term benefits for California if it ultimately could be commercialized. Having a low cost method to mitigate bat concerns could make wind energy deployment cost effective in areas that were previously marginally too expensive because of the curtailment costs. This could open up new regions in California and elsewhere for development of low cost wind energy.

Frontier Wind staff had discussions with potential clients in the wind energy sector from all over the world, and there appears to be a potential global market for this kind of technology, once it is validated in field surveys. As Frontier Wind was a California-based company, it was possible to envision the manufacturing of the Strike-Free™ system occurring in the state, with its attendant jobs and tax revenues. EPIC funds helped raise the technology to a higher technology readiness level, so it is also possible that commercialization of the system could generate royalties for the benefit of ratepayers.

GLOSSARY AND ACRONYMS

Term/Acronym	Definition
AC	alternating current
dB	stands for decibel and is a unit of sound measurement. This unit measures the loudness of a sound or the strength of a signal, computed as the signal to noise ratio.
dba	Decibel values that have been corrected using the "A" weighting system. Weightings have been created to give a loudness measurement that takes into account how the human ear actually perceives sound. In North America, the most common of these weightings is the "A" weighting.
DDS	Direct digital synthesis
DOE	U.S. Department of Energy
Energy Commission	California Energy Commission
EPIC	Electric Program Investment Charge
ESD	Electro Static Discharge
GWh	gigawatt-hours
HRWF	Hatchet Ridge Wind Facility
kHz	kilohertz. A unit of measurement of frequency, also known as cycles per second.
PCBA	printed circuit board assembly
SPI	Serial Peripheral Interface
SPL	sound pressure level
TVS Diodes	Transient Voltage Suppression Diodes
WEST	Western Ecosystems Technology

REFERENCES

- American Wind Wildlife Institute (AWWI). 2017. National Wind Wildlife Research Plan. Washington, DC. Available at www.awwi.org.
- American Wind Wildlife Institute (AWWI). 2018. AWWI Technical Report: A Summary of Bat Fatality Data in a Nationwide Database. Washington, DC. Available at www.awwi.org.
- Arnett, E.B., W.P. Erickson, J. Kerns, and J. Horn. 2005. Relationships Between Bats and Wind Turbines in Pennsylvania and West Virginia: An Assessment of Fatality Search Protocols, Patterns of Fatality, and Behavioral Interactions with Wind Turbines. Final Report prepared for the Bats and Wind Energy Cooperative. Bat Conservation International, Austin, Texas. June 2005.
- Arnett, E.B., W.K. Brown, W.P. Erickson, J.K. Fiedler, B.L. Hamilton, T.H. Henry, A. Jain, G.D. Johnson, J. Kerns, R.R. Koford, C.P. Nicholson, T.J. O'Connell, M.D. Piorkowski, and R.D. Tankersley. 2008. Patterns of Bat Fatalities at Wind Energy Facilities in North America. *Journal of Wildlife Management* 72(1):61-78.
- Arnett, E.B., M.M.P. Huso, M.R. Schirmacher, and J.P. Hayes. 2010. Altering turbine speed reduces bat mortality at wind-energy facilities. *Frontiers in Ecology and the Environment* 2010; doi: 10.1890/100103.
- Arnett EB, Huso MMP, Schirmacher MR, Hayes JP. 2011. Changing wind turbine cut-in speed reduces bat fatalities at wind facilities. *Front Ecol Environ* 9:209–214. doi: 10.1890/100103
- Arnett, E. B., & Baerwald, E. F. 2013. Impacts of wind energy development on bats: implications for conservation. In *Bat evolution, ecology, and conservation* (pp. 435-456). Springer, New York, NY.
- Arnett, E.B., C.D. Hein, M R. Schirmacher, M M. P. Huso, and J M. Szewczak. 2013. Evaluating the effectiveness of an ultrasonic acoustic deterrent for reducing bat fatalities at wind turbines. *PLoS ONE* 8(6) doi:10.1371/journal.pone.0065794.
- Baerwald, E.F., J. Edworthy, M. Holder, and R.M. Barclay. 2009. A Larger-Scale Mitigation Experiment to Reduce Bat Fatalities at Wind Energy Facilities. *Journal of Wildlife Management* 73(7):1077-1081.
- Chatfield, A., W. Erickson and K. Bay. 2009. Avian and Bat Fatality Study Dillon Wind-Energy Facility Riverside County, California, Final Report March 26, 2008 – March 26, 2009 Prepared for Iberdrola Renewables, Portland, Oregon.

- Ciocirlan, C. E. 2008. Analyzing preferences towards economic incentives in combating climate change: a comparative analysis of US states. *Climate Policy*, 8(6), 548-568.
- Cryan, P.M., and R.M.R. Barclay. 2009 Causes of Bat Fatalities at Wind Turbines: Hypotheses and Predictions. *Journal of Mammalogy*, 90(6): 1330–40.
- Flaig, K. 2015. Hatchet Ridge Invasive Weed Species 2014 Monitoring Report, Hathcet Ridge Wind, Shasta County, California.
- Good, R.E., A. Merrill, S. Simon, K. Murray, and K. Bay. 2012. Bat Monitoring Studies at the Fowler Ridge Wind Energy Facility Benton County, Indiana, April 1 – October 31, 2011. Prepared for Fowler Ridge Wind Farm. Prepared by Western EcoSystems Technology, Inc. (WEST), Bloomington, Indiana.
- Hingtgen, J. 2018. Wind Generation Summary Report 2017. California Energy Commission. Retrieved from:
https://www.energy.ca.gov/almanac/electricity_data/Wind_Gen_Summary.pdf
- Horn, J.W., E.B. Arnett, M. Jensen, and T. H. Kunz. 2008. Testing the Effectiveness of an Experimental Acoustic Bat Deterrent at the Maple Ridge Wind Farm. Report Prepared for: The Bats and Wind Energy Cooperative and Bat Conservation International, Austin, TX, 2008.
<http://www.batsandwind.org/pdf/2007ThermalImagingFinalReport.pdf>.
- Huso, M.M.P. 2010. An estimator of mortality from observed carcasses. *Environmetrics* 22: 318-329. DOI:10.1002/env.1052.
- Jain, A., P. Kerlinger, R. Curry, and L. Slobodnik. 2007. Annual Report for the Maple Ridge Wind Power Project: Post-Construction Bird and Bat Fatality Study – 2006. Final report. Prepared for PPM Energy and Horizon Energy and Technical Advisory Committee for the Maple Ridge Project Study.
- Johnson, G.D., W.P. Erickson, and M.D. Strickland. 2003. What is known and not known about bat collision mortality at windplants? In R.L. Carlton (ed.), *Proc. Workshop on Avian Interactions at Wind Turbines*, 16-17 October, 2002, Jackson Hole, WY. Electric Power Research Inst., Palo Alto, CA.
- Johnson, J. B., W. M. Ford, J. L. Rodrigue, and J. W. Edwards. 2012. Effects of acoustic deterrents on foraging bats. *Res. Note NRS-129*, USDA Forest Service, Northern Research Station http://www.nrs.fs.fed.us/pubs/rn/rn_nrs129.pdf
- Korner-Nievergelt, F, P. Korner-Nievergelt, O. Behr, .I Niermann, R. Brinkmann, and B. Hellriegel. 2011. A New Method to Determine Bird and Bat Fatality at Wind

- Energy Turbines from Carcass Searches. *Wildlife Biology* 17(4): 350–63.
doi:10.2981/10-121.
- Kerns, J., and P. Kerlinger. 2004. A Study of Bird and Bat Collisions at the Mountaineer Wind Energy Center, Tucker County, West Virginia: Annual Report for 2003. Prepared for FPL Energy and the Mountaineer Wind Energy Center Technical Review Committee. Technical report prepared by Curry and Kerlinger, LLC. February 14, 2004. 39 pp.
<http://www.wvhighlands.org/Birds/MountaineerFinalAvianRpt-%203-15-04PKJK.pdf>
- Kunz TH, Arnett EB, Erickson WP, Hoar AR, Johnson GD, Larkin RP, Strickland MD, Thresher RW, Tuttle MD. 2007. Ecological impacts of wind energy development on bats: questions, research needs, and hypotheses. *Front Ecol Environ* 5:315–324
- Piorkowski, M.D., and T. J. O’Connell. 2010. Spatial Pattern of Summer Bat Mortality from Collisions with Wind Turbines in Mixed-grass Prairie. *Am. Midl. Nat.* 164:260-269
- Schaub, A., J. Ostwald, and B. M. Siemers. 2008. Foraging bats avoid noise. *Journal of Experimental Biology* 211:3174–3180
- Tetra Tech. 2014. Hatchet Ridge Wind Farm Post-Construction Mortality Monitoring Comprehensive Three Year Report. Submitted to Hatchet Ridge Wind, LLC, May 2014. 59 pp.
- US Fish and Wildlife Service (USFWS). 2010. Wind Turbine Guidelines Advisory Committee Recommendations. Washington, DC. 84 pp.
- Young, D.P., G.D. Johnson, V.K. Poulton and K. Bay. 2007. Ecological Baseline Studies for The Hatchet Ridge Wind Energy Project, Shasta County, California. Prepared for: Hatchet Ridge Wind, LLC Portland, Oregon. Prepared by WEST, Inc. Cheyenne, WY, August 31, 2007.
- Young, D.P., Erickson, W.P., Bay, K., Nomani, S., and W. Tidbar. 2009. Mount Storm Wind Energy Facility, Phase 1 Post-Construction Avian and Bat Monitoring. July-October 2008. Prepared for NedPower Mount Storm, LLC. 54 pp.

APPENDIX A: Strike-Free™ System Requirements Specification

Introduction

This appendix is the initial description of the Strike Free™ system for a utility class wind turbine installation. It describes the operational concept, system goals, system requirements, reliability requirements, maintenance plan, and controls plan. In addition, it details each individual physical component function, interface, and specification. The specification was developed early in the project

Frontier Wind's Customer Requirements for the Strike Free™ System

Frontier Wind has identified criteria important to the Strike Free™ customer. This will allow the design team to understand what drives the product requirements and allows understanding of how to deliver the requirements at a low cost.

- Lower the cost of energy.
- Allow certification of the wind turbine
- Be reliable and maintenance free for 20 years
- Have minimal susceptibility to lightning
- Reduce overall noise generation of the wind turbine, if this is not possible only increase the noise by a maximum of 1 dBA shall be allowed
- Have minimal lead time increase in production capacity of the wind turbine at their manufacturing facilities

Strike Free™ System Description

The Strike Free™ system consists of three main components. First, is an array of ultrasonic transmitters installed along the blade span, a wire harness to transmit electrical signals to those transmitters, and a controller / amplifier to send amplified signals to drive the transmitters.

Strike Free™ Control System Description

The Control System is responsible for the signal generation and amplification of the Strike Free™ system. The system requires at a minimum the ability to maintain the correct time at the installed location either via a network time controller, or Global Positioning System (GPS) time signal. In addition to control and amplification, the

control system shall be updateable and report system health. This document describes the requirements for the control system.

The control system architecture is not defined and shall be conceptualized in the first phase of this project. Frontier Wind desires a low cost architecture that reduces the cost of the hardware, possibly utilizing a centralized control system to achieve target cost and budget goals.

Strike Free™ Control System Interface

Controller

The control system shall run and interface with Frontier Wind's controller that activates the system at different times of day, and is also capable of operating at different times of the year. Based on past experience with Frontier Wind's other products, a real-time Linux-based operating system is the preferred basis. This allows interface and control that can be written in the C++ programming language. The C++ code could be embedded into the code for the system controller.

HMI

The HMI shall be selected in the first design phase of this project. The interface shall be simple and low cost. No external displays or user interfaces are required. A potential solution is to connect to the control system with a laptop with a text based user interface.

Remote Firmware and Parameter Update

The firmware and parameters of the control system shall be capable of being updated from a remote location (for example from the base of the wind turbine tower). If costs allow, a feature that is not a requirement of this development is access via the internet. If enabled, remote firmware and parameter update via internet access may be desired. Note: As time progresses, more wind turbines are connected to a SCADA system for remote control and to monitor the health condition of the wind turbine.

Control Modes

The Controller shall enable the following operational control modes: Manual, Auto, Script, and Maintenance Modes.

- Manual Mode
 - The Controller shall enable a user to set frequencies and modulations of the signal generated for the amplifiers.
- Auto Mode
 - The Controller shall be capable of executing Control code written in C++. The Control code shall process inputs from a time server or GPS signal with auxiliary information about turbine status and make a decision to

activate the amplifier and drive the ultrasonic transducers. In all modes the real time control loop shall operate at a defined rate.

- Script Mode
 - The Controller shall be capable of reading and interpreting a script file containing requested amplifier(s) for all three blades and a time delay, in increments of the defined "Real Time Control Period", which the Controller shall wait before executing the following line in the script.
 - The Controller shall offer the option to repeat a script a number of times or indefinitely, such as a toggle mode. Toggle mode is a subset of Script mode which is intended to be a short script generated to activate selected amplifiers with a specific frequency or set of frequencies, operated for a number of events or times.
 - Toggle Scripts contain a combination of active amplifier(s) for each blade and a time in milliseconds between each burst. Toggle Script file formats are text files containing multiple lines of commands to amplifier devices.
- Maintenance Mode
 - Maintenance mode has been an effective debug tool in past developments where all communications shall be silenced to solely send signal generator and amplifier commands, writing control parameters, or updating firmware.

Control Architecture

The system architecture shall be configured to allow the controller to operate the following control architectures simultaneously.

- Single-amplifier control
 - Single-amplifier centric control element to independently actuate a single transmitter
- Multiple-amplifier control
 - Centralized control element to independently actuate transmitters on each blade

Intellectual Property Security

The control law is Frontier Wind's intellectual property. The control law shall have security features to prevent unauthorized users from accessing and copying the code.

Non-Required Features

The following features are nice to have, but are not a requirement. These features should be implemented if costs allow.

- Store data and send data to external Logger

- Access via the internet

Design Options

Past products have used variations of a control system that has a centralized controller, however all architectures are open to consideration, a decentralized control system may be considered. Depending on the amplification requirements, the ultrasonic transmitters can be driven as single devices, in series, or in parallel. The amplification architecture should be chosen to maintain system robustness in the event that a device fails, and is able to detect when a transmitter and/or amplifier has failed.

System Requirements

Table A-1: Strike Free™ System Requirements

	Item	Requirement
1.1.1	Number of transmitters required	0 to a maximum of 20 per Blade
1.1.2	Transmitter Frequency Range	20 kHz – 100 kHz
1.1.3	Transmitter Sound Pressure Level (SPL)	65 dB +/- 5 dB at 20 meters
1.1.4	Frequency Coverage	80% of the frequency range at required SPL's
1.1.5	Strike-Free Status Update Rate (To Logger: Devices activated, Faults, Mode, etc)	Data Rate 1 Hz
1.1.6	Amplifier Enable Commands	Data Rate 1 Hz
1.1.7	Turbine data - Rotor Speed - Radians/second	Data Rate 1 Hz
1.1.8	MET data - Rho - Air Density or Barometric Pressure	Data Rate 1 Hz
1.1.9	Maximum Processor Utilization	50%

Source: Frontier Wind

Table A-2: Strike Free™ Electrical System Requirements (if physical hardware is required)

	Item	Requirement
1.2.1	See “Strike-Free System EMC, EMI, Lightning and ESD Compliance” table	

Source: Frontier Wind

Table A-3: Strike Free™ Mechanical Requirements (if physical hardware is required)

	Item	Requirement
1.3.1	Vibration Resistance	IEC 61373 - 5g rms: 10-150 Hz all orientations Class B
1.3.2	Shock	IEC 61373 – 3g rms: 30 ms all orientations Class B
1.3.3	Hub Components - Max Centripetal Loads	Centripetal Acceleration Field of 2g rms
1.3.4	Blade Components - Max Centripetal Loads	Centripetal Acceleration Field of 20g rms

Source: Frontier Wind

Table A-4: Strike Free™ Environmental Requirements (if physical hardware is required)

	Item	Requirement
1.4.1	Electronics Enclosure Environmental Rating	IP 65
1.4.2	Operating Temperature	-40 to +55°C (ambient air)
1.4.3	Relative Humidity	5% - 95%
1.4.4	Elevation	3000 m (10,000 ft)

Source: Frontier Wind

Table A-5: Strike Free™ Reliability Requirements (if physical hardware is required)

Number	Item	Requirement
1.5.1	Minimum Predicted Life using Telecordia prediction models and Reliability Block Diagrams	MTBF of 20 years
1.5.2	Material Degradation life due to UV Exposure and Weathering	20 years

Source: Frontier Wind

Table A-6: Strike Free™ Certification Requirements (if physical hardware is required)

Number	Item	Requirement
1.6.1	European Machinery Directive	Components shall be CE marked, if necessary
1.6.2	RoHS	Directive 2002/95/EC (RoHS)
1.6.3	UL	UL marked

Source: Frontier Wind

Table A-7: Strike Free™ System EMC, EMI, Lightning and ESD Compliance

	EMC, EMI, Lightning and ESD Compliance	Specification Standard	Test Levels	Performance Criteria (IEC 61000-6-2)
1.7.1	Lightning Surge Protection	IEC 61400-24 IEC 62305-1 Clause 8	8 kV - 1,2/50µs LPZ0B 200KA 350uSec decay to 50%.	
1.7.2	Safety for Electrical Equipment	IEC 60204-1		
1.7.3	Low Voltage Compliance	IEC 60364 series		

Source: Frontier Wind

Table A-8: Strike Free™ System EMC, EMI, Lightning and ESD Compliance – Enclosure

	EMC, EMI, Lightning and ESD Compliance	Specification Standard	Test Levels	Performance Criteria (IEC 61000-6-2)
1.7.4	ESD Requirement	IEC 61000-4-2: 2008-12	CD (contact discharge): 4kV AD (air discharge): 8kV	B
1.7.5	Electromagnetic Field Immunity	IEC 61000-4-3:2010-04	10 V/m (80MHz to 1GHz) 3 V/m (1.4 GHz to 2 GHz) 1 V/m (2 GHz to 2.7 GHz)	A
1.7.6	Pulse Magnetic Field	IEC 61000-4-9	1000 A/m (pulsed magnetic field by test pulse 6.4/16µs)	B
1.7.7	Damped Oscillatory Magnetic Field	IEC 61000-4-10	100 A/m (peak value at damped magnetic field with 30 kHz ≤ f ≤ 10 MHz)	B

Source: Frontier Wind

Table A-9: Strike Free™ System EMC, EMI, Lightning and ESD Compliance – DC Power Inputs

	EMC, EMI, Lightning and ESD Compliance	Specification Standard	Test Levels	Performance Criteria (IEC 61000-6-2)
1.7.8	Fast Transients (Burst)	IEC 61000-4-4	±4kV (5/50ns at fR=100kHz)	B
1.7.9	Surge Voltages	IEC 61000-4-5	1) ±2kV 2) ±4kV	B
1.7.10	Conducted disturbances by radio frequency induced fields	IEC 61000-4-6	10V (150kHz ≤ f ≤ 80MHz)	A

Source: Frontier Wind

Table A-10: Strike Free™ System EMC, EMI, Lightning and ESD Compliance – Signal and Data Communication Ports

	EMC, EMI, Lightning and ESD Compliance	Specification Standard	Test Levels	Performance Criteria (IEC 61000-6-2)
1.7.11	Fast Transients (Burst)	IEC 61000-4-4	±2kV (5/50ns bei fR=100kHz)	B
1.7.12	Surge Voltages	IEC 61000-4-5	1) ±2kV 2) ±4kV	B
1.7.13	Conducted disturbances by radio frequency induced fields	IEC 61000-4-6	10V (150kHz ≤ f ≤ 80MHz)	A

Source: Frontier Wind