

Extended Abstracts for
Oxford Tidal Energy Workshop
29-30 March 2012, Oxford, UK



Extended Abstracts for
Oxford Tidal Energy Workshop
29-30 March 2012, Oxford, UK

Day 1 (29th March)

Session 1

- 11:10 **The Influence of Vertical Velocity Shear on Tidal Turbine Performance and Wake Recovery**
Simon C. McIntosh (University of Oxford) 3
- 11:35 **“From Vessel to Model”: Bridging the Gap between Real and Modelled Flow Data**
Paul Evans (Cardiff University) 5
- 12:00 **Characterisation of the Coastal Hydrology of Oceans Using 3D Computational Fluid Dynamics**
Enayatollah Zangiabadi (Swansea University) 7
- 12:25 **The Influence of Turbulence Model on Wake Structure of TSTs when used with a Coupled BEM-CFD Model**
Rami Malki (Swansea University) 9

Session 2

- 14:00 **Investigation of the influence of turbine to turbine interaction on their performance using OpenFOAM**
Gavin R. Tabor (University of Exeter) 11
- 14:25 **Near-field flow downstream of a barrage: Experiments and 3-D modelling**
Penelope Jeffcoate (University of Manchester) 13
- 14:50 **Sediment dynamics in the wake of a tidal current turbine**
Lada Vybulkova (University of Glasgow) 15

Session 3

- 15:45 **A cross-flow device with an oval blade path: predictions and measurements of blade forces**
Peter B. Johnson (University College London) 17
- 16:10 **Are Nearly all Tidal Stream Turbines Designs Wrong?**
Stephen Salter (University of Edinburgh) 19
- 16:35 **Experimental results from 1/20th scale model tests of the Transverse Horizontal Axis Water Turbine**
Ross A. McAdam (University of Oxford) 21

Day 2 (30th March)

Session 4

9:20	CFD Simulation of a 3-Bladed Horizontal Axis Tidal Stream Turbine using RANS and LES J. McNaughton (University of Manchester)	23
9:45	Computational Modelling of Unsteady Rotor Effects Duncan M. McNae (Imperial College London)	25
10:10	Development of an Actuator Line Model for Tidal Turbine Simulations Justine Schluntz (University of Oxford)	27
10:35	Modification of Open Channel Flow By Opposing Waves A. Olczak (University of Manchester)	29

Session 5

11:30	Prediction and Measurement of Time-Varying Thrust on Tidal Turbine due to Mean and Oscillatory flow E. Fernandez Rodriguez (University of Manchester)	31
11:55	Blade Element Momentum Theory for Tidal Turbine Simulation with Wave Effects: A Validation Study Hannah C. Buckland (Swansea University)	33
12:20	The Buhl High-Induction Correction for Blade Element Momentum Theory Applied to Tidal Stream Turbines Michael Togneri (Swansea University)	35
12:45	Betz revisited Guy T. Houlsby (University of Oxford)	

Session 6

14:00	Numerical Analysis of Open-Centre Ducted Tidal Turbines Clarissa S. K. Belloni (University of Oxford)	37
14:25	Evaluation of FVNS Solvers for Structures in Tidal Flow Robert Stringer (University of Bath)	39
14:50	On the Garrett & Cummins limit Thomas A.A. Adcock (University of Oxford)	41

Workshop Organisers: Dr Richard H. J. Willden (University of Oxford)
Dr Takafumi Nishino (University of Oxford)
Prof. Guy T. Houlsby (University of Oxford)
Dr Tim Stallard (University of Manchester)

Sponsor: Oxford Martin School, University of Oxford

The Influence of Vertical Velocity Shear on Tidal Turbine Performance and Wake Recovery

Simon C. McIntosh*, Conor F. Fleming and Richard H. J. Willden
Department of Engineering Science, University of Oxford, OX1 3PJ, UK

Summary: The extent of vertical velocity shear expressed in tidal flows is highlighted with extracts of field data taken from the Falls of Warness in the Pentland Firth. Resulting velocity profiles reveal distinct divergences in shape for the same mean speed during flood and ebb tides with the ebb profile observed to be much fuller than the low shear $1/7^{\text{th}}$ power law used by the wind industry. A method of applying a Log-law fit to the field data profiles is presented resulting in the calculation of ebb and flood bed roughness heights of 0.015 and 0.127 m. The impact of operating turbines within the high shear tidal environment is assessed computationally at approximately $1/30^{\text{th}}$ geometric scale.

Two bed roughness cases are presented representative of the ebb and flood field data with mean flow approx. 0.27 m/s. A uniform flow case is also simulated to provide a datum for evaluation of the effect of sheared flow. High levels of vertical velocity shear commensurate with real tidal flows are found to reduce overall power output by an applicable fraction compared to the uniform flow case. The majority of this power decrease is attributed to flow field asymmetry at the rotor plane. Since pitch angle is fixed, asymmetry of incident flow results in variation of relative velocity during each revolution and so the blade operates at a lower lift to drag ratio for part of each revolution. Bed shear and the associated higher turbulence levels are found to accelerate wake mixing resulting in a downstream profile recovery much faster than the uniform flow case.

Introduction

Vertical velocity shear, the spatial variation of stream-wise velocity with distance from the seabed, is highly pronounced for energetic tidal flows. Large spatial gradients result in significant variation of flow variables across the swept area of a rotor. This in turn influences the distribution of loads acting on the each blade and hence alters performance coefficients relative to the idealised case of uniform flow.

Similar vertical velocity shears are observed to act across large wind turbines operating within the atmospheric boundary layer. Indeed many of the analysis techniques developed for wind shear are directly applicable to tidal flows. The exception for tidal flows is the vertical extent over which the seabed boundary layer is able to expand. For atmospheric flows the boundary layer is effectively unbounded where as for tidal flows the presence of a free surface limits the shear layer's vertical extent. In the case of shallow depth high velocity tidal flows this vertical constraint on shear layer development produces significant gradients acting throughout the water column and across any tidal device placed within the flow.

Methods

The magnitude of vertical velocity shear for real tidal flows is assessed via the analysis of six days of tidal velocity measurements taken from the Falls of Warness in the Pentland Firth. The level of vertical velocity shear is characterised for both the flood and ebb tides; with a large variation observed between the ebb and flood profiles. Sheared flow simulations are then carried out to assess the impact of a realistically sheared velocity profile on the loading, performance and wake recovery of a horizontal axis tidal turbine.

* Corresponding author.

Email address: simon.mcintosh@eng.ox.ac.uk

Results

Figure 1 shows a highly sheared velocity profile abstracted from the field data for a mean flow speed of 2 m/s during a flood tide. Also shown are associated $1/5^{\text{th}}$, $1/7^{\text{th}}$ and log-law fits. The low-shear $1/7^{\text{th}}$ power law, used extensively in the wind industry, is shown to significantly under predict the level of shear present in the profile. A much better fit is obtained using a $1/5^{\text{th}}$ power law with the best performing model provided by a log-law fit employing a roughness height of 0.127m.

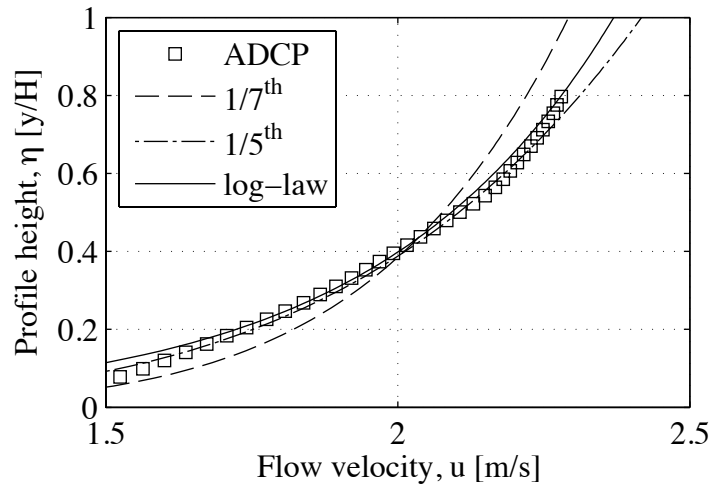

Figure 1: An illustration of the time averaged velocity profile for the flood tide recorded at the Falls of Warness with comparison to $1/5^{\text{th}}$, $1/7^{\text{th}}$ and log-law velocity fits.

Computational simulations of a $1/30^{\text{th}}$ scale horizontal axis turbine are carried out employing the above log-law velocity inflow along with associated variations in turbulence intensity and dissipation rate. Vertical velocity shear is found to reduce power output by an appreciable fraction compared to operation in a uniform inflow. In addition, wake mixing is observed to occur much more rapidly for the sheared flow case with a recovery of upstream profiles much faster than observed for the uniform inflow case.

Conclusions

The level of vertical velocity shear observed at the Falls of Warness site is found to be much greater than that predicted by typical $1/7^{\text{th}}$ power law models adopted from the wind industry. A $1/5^{\text{th}}$ power law is shown to provide a more suitable fit to the field data. A log-law variation employing a terrain roughness height of 0.127m provides a representative model of the vertical velocity shear. Compared to uniform flow calculations, simulations of this highly sheared tidal environment predict a fall in power coefficient by an appreciable fraction along with a reduction in the distance over which the wake velocity recovers to the ambient profile.

Acknowledgements:

This study was completed as part of the PerAWaT project commissioned by the Energy Technologies Institute (ETI).

“From Vessel to Model”: Bridging the Gap between Real and Modelled Flow Data

Paul Evans* and Christopher Wooldridge

School of Earth and Ocean Sciences, Cardiff University, CF10 3AT, UK

Allan Mason-Jones, Tom O’Doherty and Daphne O’Doherty

School of Engineering, Cardiff University, CF24 3AA, UK

Simon Neill and Reza Hashemi

School of Ocean Sciences, Bangor University, LL59 5AB, UK

Rami Malki, Ian Masters and Enayatollah Zangiabadi

College of Engineering, Swansea University, SA2 8PP, UK

Summary: A shipboard acoustic Doppler current profiler (ADCP) has been used to obtain detailed measurements of the tidal flow structure in an area off the Welsh coastline where tidal currents typically peak at 3-4 ms⁻¹ during spring tides. This paper describes the importance of such field data for the calibration and validation of numerical models for tidal stream power generation.

Introduction

ADCP surveys have been undertaken within the Bishops and Clerks (including Ramsey Sound) off the west coast of Wales, UK, which has a combined extractable power estimate of 541 GWh/y [1]. The principal objective of these surveys was to examine the region’s tidal stream resource potential, as well as understanding the hydrodynamics of the region. Given its resource potential, this region has been earmarked by the Welsh Government as a potential site for tidal stream energy generation, with the first Welsh developer gaining consent in July 2011 to deploy a single device for a 12 month period within Ramsey Sound. Previous work off the Welsh coast included a series of shipboard ADCP surveys within a 1km² area in the Bristol Channel to study power attenuation effects on turbine performance [2].

The data was collected onboard Cardiff University’s 12 m RV *Guiding Light* as part of the Low Carbon Research Institute (LCRI) Convergence Programme. This paper discusses the benefit of tidal flow data for use within numerical models and demonstrates its importance for validation and calibrations purposes to help bridge the gap between physical data collection and pure mathematical modelling.

Methods

The ADCP data, which was collected during two major deployments in May and August 2011, involved the completion of 260 vessel tracks (equating to over 200 nautical miles) over a range of tidal states within the Bishops and Clerks. A 1.0 MHz shipboard ADCP with bottom-track capabilities was mounted on a detachable mount on the side of RV *Guiding Light* for the ADCP surveys.

A series of numerical models have been employed as part of this research project to investigate various elements of marine renewable energy generation, including a three-dimensional (3D) unstructured oceanographic model (ADCIRC) of the Bishops and Clerks (inclusion of turbines in this

* Corresponding author.

Email address: EvansPS3@cardiff.ac.uk

model follows a methodology developed in earlier work [3]), a standard finite volume CFD approach with a k- ϵ turbulence model, a coupled Blade Element Momentum (BEM-CFD) model, and a transient CFD model (which was used to examine the performance of a horizontal axis tidal turbine for a similar project [4]) investigating power attenuation in an array of turbines.

Results

Vector plots of the hydrodynamic regime of the western-most point of mainland Wales have been established. Scrutiny of these vector plots, in addition to on-site observations of phenomena such as up-welling, eddies and vortices, has identified the significant flow characteristics of major tidal channels. Preliminary results have revealed characteristics of the interrelationships between coastal configuration and bathymetry and hydrodynamics of the areas. Although the tidal regime in this region is well-established, the results indicate the extent to which smaller-scale features, such as geographical salients, and point and linear features (Horse Rock and The Bitches) are significant in influencing the principal tidal flow. Low pressure and areas of significant turbulence and vertical mixing form in the wake of these features. The outcrops that form the Bishops and Clerks were originally thought to channel tidal flow; however, at certain states of the tide local pressure fields build up to create a further complex of back-tides and localised eddy systems. The results suggest that well-developed jet streams exist in close proximity to narrow, deep channels and that the resultant chaotic system is characterised by extreme turbulence, standing waves, well-defined vertical mixing, vortices, eddies and locally significant flow anomalies.

Interpretation of the vectors using 2D and 3D visualisation techniques at different tidal states has identified key hydrodynamic areas to quantify the flow structure and deviations from it. This information is vital for the calibration, validation and ground-truthing of mathematical models. Future work will explore the possibility of using a linear set of features, like the Bishops and Clerks rocks, as an analogy for a tidal stream array and the effects downstream of such an array.

Conclusions

Results confirm that even small-scale variations in bathymetry and coastal configuration may have a profound influence on the resultant flow regime. It has also been recognised that vectors change in space and time to a far greater extent than expected.

Acknowledgements:

The authors acknowledge the financial support of Welsh Assembly Government, the Higher Education Funding Council for Wales, the Welsh European Funding Office and the European Regional Development Fund Convergence Programme. The authors also acknowledge with grateful thanks the collaboration and assistance of LCRI Marine partners, RNLI St David's and St Justinian's Boat Owners Association. Navigational advice from David Chant based on his experience as an RNLI coxswain and fisherman was invaluable for site-selection and general safety at sea.

References:

- [1] Fairley, I., Neill, S., Wrobelowski, T., Willis, M. and Masters, I. (2011). Potential array sites for tidal stream turbine electricity generation off the Pembrokeshire coast. *Proc. 9th European Wave and Tidal Energy Conference (EWTEC)*, Southampton, UK.
- [2] Willis, M., Masters, I., Thomas, S., Gallie, R., Loman, J., Cook, A., Ahmadian, R., Falconer, R., Lin, B., Gao, G., Cross, M., Croft, N., Williams, A., Muhasilovic, M., Horsfall, I., Fidler, R., Wooldridge, C., Fryett, I., Evans, P., O'Doherty, T., O'Doherty, D. and Mason-Jones, A. (2010) Tidal Turbine Deployment in the Bristol Channel – A Case Study, *Proc. ICE Energy*. **163** (3), 93–105.
- [3] Neill, S., Jordan, J. and Couch, S. (2012). Impact of tidal energy converter (TEC) arrays on the dynamics of headland sand banks. *Renewable Energy*, **37** (1), 387-397.
- [4] O'Doherty, T., Mason-Jones, A., O'Doherty, D., Evans, P., Wooldridge, C. and Fryett, I. (2010). Consideration of a Horizontal Axis Tidal Turbine. *Proc. ICE Energy*. **163** (3), 1751-4223.

Characterisation of the Coastal Hydrology of Oceans Using 3D Computational Fluid Dynamics

Enayatollah Zangiabadi*, Ian Masters
College of Engineering, Swansea University, SA2 8PP, UK

Alison. J. Williams
College of Engineering, Swansea University, SA2 8PP, UK

Summary: Knowing the properties of the flow is required to set up a tidal stream turbine (TST). Modelling of the flow in an estuary or a channel which has severe conditions depends on several parameters such as the bed friction factor and topography of the seabed. Characterising the flow profile and predicting the behaviour of the boundary layer in channels with different dimensions and different flow conditions should be investigated in order to have an accurate model. It is also necessary to study the effect of different friction coefficients on the velocity profile.

Introduction

Marine devices are used to harness hydrokinetic energy of tides, waves and currents in oceans, rivers and streams. The developments of such devices are in preliminary stages but their significant contribution to the future supply of clean energy is obvious in both the UK and also around the world. Tidal energy has been developed more in comparison to other methods of marine renewable energies, mainly because this kind of renewable energy is fully predictable. However, marine and estuarine environments are characterised by roughness and irregularity in topography and three-dimensional (3D) turbulent flows, which can hugely affect the performance of Tidal Stream Turbine (TST) and should be investigated carefully [1].

Generally, when a fluid flows over a solid surface, the velocity of fluid relative to the surface is zero and as we move away from the surface the velocity rapidly increases to the velocity of the main stream and forms the boundary layer. Near the surface the shear stress is more effective and beyond the boundary layer the effect of viscosity is negligible [2]. The boundary layer along with the main stream flow determines the velocity profile of the flow above the surface. One of the important parameters which affect the shape of the boundary layer is the roughness of the surface and the velocity gradient is reformed with changing of the bed friction coefficient. Rocks, pinnacles and severe changes in bathymetry can also affect the shape of the velocity profile and therefore affect the overall performance of a TST.

Methods

A standard finite volume approach with a $k-\varepsilon$ turbulence model has been used. For the transport of any fluid the governing equations are the continuity equation and the momentum equation. This is a two equation model, which means, it includes two extra transport equations to calculate the turbulent kinetic energy, k , and the turbulent dissipation rate, ε .

The turbulence and the momentum equations are coupled through the dynamic viscosity which is a sum of the laminar and turbulent values. In the current problem, as density of a fluid element does not change during its motion we deal with incompressible flow. Besides that, there are no external source terms.

* Corresponding author:
Email address: 502830@swansea.ac.uk

Another approach to determine the velocity gradient over the seabed is the logarithmic law of wall formula [3]. The law of the wall states that the average velocity of a turbulent flow at a certain point is proportional to the logarithm of the distance from that point to the "wall", or the boundary of the fluid region [4]. The law of wall is theoretically appropriate to parts of the flow which are close to the wall (<20% of the height of the flow), however with a good approximation it is acceptable for the entire velocity profile of natural streams, especially in coastal flows, where the depth is small in comparison to the horizontal dimensions [5].

Results

The model was run for smooth, intermediate and rough beds with uniform and power-law inlet boundary conditions. A regular orthogonal mesh was used. The minimum cell length was 250 mm and the domain length was 3200 m. It was decided to extract the velocity gradient close to the inlet (300 m) and near the outlet (3000 m) to investigate change of the velocity profile as the flow transport along the length of the channel. The depth of the channel was 30 m and one value for velocity was extracted for every meter of depth.

Conclusions

Both of the methods (law of wall and bed roughness) will be used in channels with variable topography and then by comparing the results with real data, the best one will be selected to use for future simulations.

The results validation will be done by applying the boundary conditions which will be based upon flow data gathering by Acoustic Doppler Current Profiler (ADCP) survey in Operation Celtic Odyssey IV late spring this year.

References:

- [1] Seokkoo Kang, Iman Borazjani, Jonathan A. Colby, Fotis Sotiropoulos (2012). Numerical simulation of 3D flow past a real-life marine hydrokinetic turbine. *Advances in Water Resources*. **39**:33-43.
- [2] Bernard Massey. (1998). Boundary layer and wakes. In: John Ward-Smith *Mechanics of Fluid*. 7th ed. UK: Nelson Thornes Ltd. 312.
- [3] Emmanuel Osalusi, Jonathan Side and Robert Harris (2009), Reynolds stress and turbulence estimates in bottom boundary layer of Fall of Warness,
- [4] Th. v. Karman (1931), *Mechanical Similitude and Turbulence*,
- [5] David Mohrig (2004), Conservation of Mass and Momentum. 12.110: Sedimentary Geology. MIT OCW.

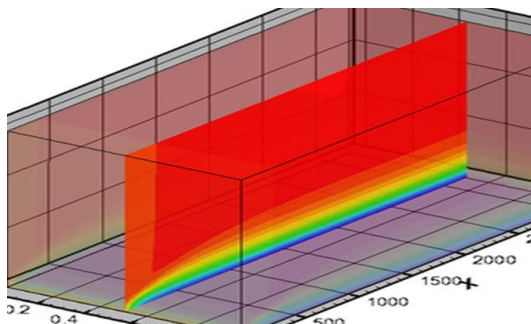

Fig. 1. Velocity profile of a flat channel for uniform flow

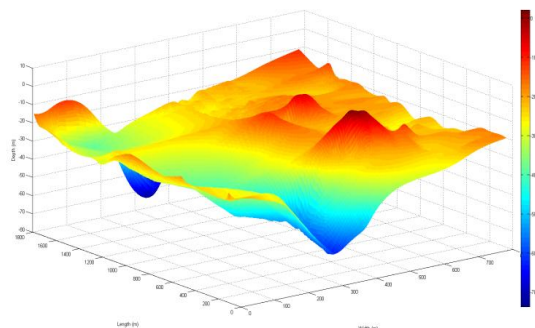

Fig. 2. The Bathymetry of Ramsey Sounds while looking towards northeast
(The graph has been generated by data acquired from Seazone, Olex chart systems and the Royal Navy)

The Influence of Turbulence Model on Wake Structure of TSTs when used with a Coupled BEM-CFD Model

Ian Masters, Rami Malki*, Alison Williams and Nick Croft
Marine Energy Research Group, Swansea University, SA2 8PP, UK

Summary: A coupled Blade Element Momentum - Computational Fluid Dynamics (BEM-CFD) model is used to simulate tidal stream turbines. The simulations are conducted using three different turbulence models, namely the $k-\varepsilon$, $k-\varepsilon$ RNG and $k-\omega$ models. The significance of the choice of turbulence model on wake hydrodynamics is evaluated.

Introduction

Errors in numerical simulations of tidal stream turbines using the coupled BEM-CFD method can arise due to a number of reasons, such as the steady-state representation of an unsteady process, discretisation of the blade, blockage effects and not accounting for the displacement of the water surface. Another source of uncertainty in the results which is addressed in this study is the choice of turbulence model. In this study, the coupled BEM-CFD model is applied with three different two-equation turbulence models to evaluate their significance on the flow structure downstream of the turbine rotor.

Methods

A coupled BEM-CFD model [1] is used to simulate a tidal stream turbine in conjunction with three different two-equation turbulence models, namely the standard $k-\varepsilon$, $k-\varepsilon$ RNG and $k-\omega$ models. The simulations are of a 0.5 m diameter rotor in a 1.4 m wide and 0.85 m deep flume based on the setup of the experimental testing undertaken at the University of Liverpool [2].

Two tip speed ratios are considered: 4.0, which is the optimum value for the rotor used, and this is compared to a non-optimum case of 6.0. The inflow velocity was set to 1.0 m s^{-1} which is within the range of velocities implemented during the experimental investigation.

Results

Contours of velocity and turbulence intensity along vertical slices passing through the centre of the rotor along the flow direction are presented in Fig. 1. Both sets of plots indicate subtle differences in the flow structure downstream of the rotor. The lowest velocity region immediately downstream of the nacelle was longest for the $k-\varepsilon$ RNG model and shortest for the $k-\omega$ model. This can be related to turbulence generation, at the nacelle surface which resulted in the highest turbulence intensities for the $k-\omega$ model and the lowest for the $k-\varepsilon$ RNG model.

Velocity and turbulence intensity profiles along the centreline through the rotor are presented in Fig. 2. The velocity profiles indicate that flow recovery occurs over the shortest distance when using the $k-\omega$ model and occurs over the longest distance when using the $k-\varepsilon$ RNG model.

Downstream of the rotor circumference, turbulence intensity peak values were greatest for the $k-\omega$ model, and the high turbulence intensity regions extended further downstream. For the $k-\varepsilon$ RNG model, turbulence intensity peak regions occurred further downstream along the wake.

* Corresponding author.

Email address: r.malki@swansea.ac.uk

Conclusions

The choice of turbulence model can have some influence on the wake structure downstream of a tidal stream turbine. Quantifying the wake length based on a percentage value of the free-stream velocity can yield significantly different predictions for the various models. More measured velocity data within the wake region is required to evaluate the suitability of different options.

The current model accounts for the influence of the blades within the momentum equations, however future work will focus on including further source terms within the turbulence model equations. This may improve the representation of large-scale turbulence breakdown into small scale turbulence.

Acknowledgements:

This work was undertaken as part of the Low Carbon Research Institute Marine Consortium (www.lcrimarine.org).

The Authors wish to acknowledge the financial support of the Welsh Assembly Government, the Higher Education Funding Council for Wales, the Welsh European Funding Office, and the European Regional Development Fund Convergence Programme.

References:

- [1] Williams A.J., Croft T.N., Masters I., Bennet C.R., Patterson S.G. and Willis M.R. (2010). "A combined BEM-CFD model for tidal stream turbines". 3rd International Conference on Ocean Energy, Bilbao.
- [2] Tedds S.C., Poole R.J., Owen I., Najafian G., Bode S.P., Mason-Jones A., Morris C., O'Doherty T. and O'Doherty D.M. (2011). "Experimental Investigation of Horizontal Axis Tidal Stream Turbines." *EWTEC 2011*, Southampton, UK.

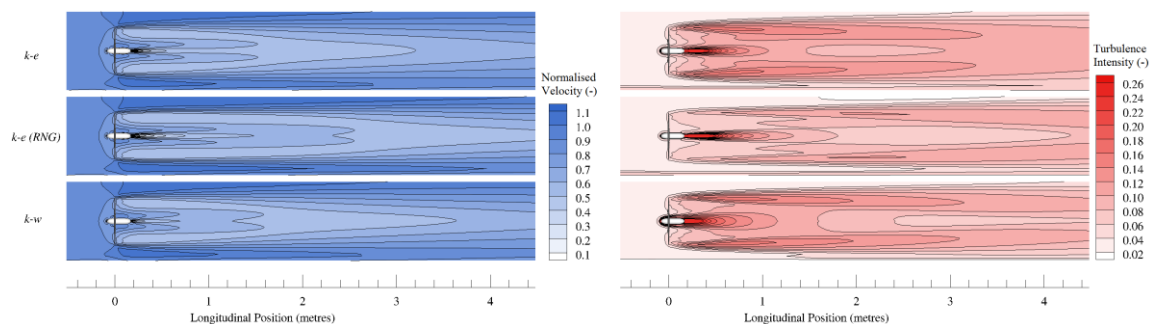

Fig. 1 Velocity and Turbulence Intensity Contour Plots ($U = 1.0 \text{ m s}^{-1}$; $\text{TSR} = 4.0$)

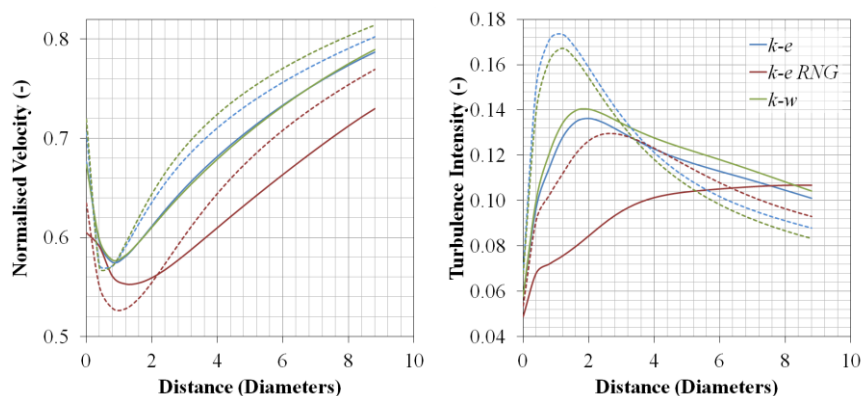

Fig. 2 Velocity and Turbulence Profiles ($U = 1.0 \text{ m s}^{-1}$; $\text{TSR} = 4.0$ (solid), 6.0 (dashed))

Investigation of the influence of turbine to turbine interaction on their performance using OpenFOAM

Gavin R. Tabor*, Muluaem G. Gebreslassie, Michael R. Belmont
College of Engineering, Mathematics and Physical Sciences, University of Exeter,
North Park Road, EX4 4QF, UK

Summary: This paper presented the influence of turbine to turbine interaction on the performance of individual turbines using a new CFD based model, *immersed body force* (IBF). The results showed that a lateral proximity of turbines can improve the performance of individual turbines in a farm compared to isolated devices due to a blockage effect. However, this might have a negative effect on downstream turbines that can affect the overall power output of the farm, which opens the way for further investigation using upstream and downstream turbines to obtain an optimized location of the devices.

Introduction

The study of turbine to turbine interaction is crucial to understand how energy shadowing of an array of devices influences energy extraction from the individual devices. However, investigation of these interactions using experiments could inflict significant cost especially with several devices in a tidal stream farm. The best option to minimise this cost is therefore to use alternative methods such as numerical simulations using computational fluid dynamics (CFD) software packages. In recent years, CFD has been commonly used in modelling the flow features of tidal turbines and showed satisfactory results.

The focus of this study was on a new class of tidal turbine, Momentum Reversal Lift (MRL), designed by Aquascientific Ltd, which is currently in the prototype and testing phase [1]. The aim being to investigate the turbine to turbine interaction of three devices configured laterally in a cross flow using a simplified CFD based model called *immersed body force*.

Computational modelling

Large-eddy simulation (LES) was utilized to simulate the MRL turbine using an open source CFD code, OpenFOAM. The LES governing equation is a combination of the filtered Navier-Stokes (NS) equations [2] and source terms as shown in Eq. (2). The LES governing equation can be defined as:

Continuity equation:

$$\nabla \cdot U = 0 \quad \text{Eq. 1}$$

Momentum equation:

$$\frac{\partial \rho U}{\partial t} + \nabla \cdot (\rho U U) = -\nabla p + \nabla \cdot \mu \nabla U + \rho g + F_s + F_b \quad \text{Eq. 2}$$

where, U is the filtered velocity, p is the filtered pressure, μ is the dimensionless dynamic viscosity, F_s is the surface tension, g is the gravitational acceleration. In this study, a new source term, forcing function (F_b), was added to create a momentum change in the fluid flow. The forcing function was used to represent the force applied by the immersed body (turbine) and can be defined as:

$$F_b = F_D + F_L \quad \text{Eq. 3}$$

This new source term is named as *immersed body force* and a code was developed considering drag (F_D) and lift (F_L) forces. It is a compromise between at one extreme a full treatment using offset meshing and/or sliding mesh techniques to describe the detailed internal blade motions and at the other a highly simplified momentum extraction zone such as the porous disc method.

* Corresponding author.

Email address: G.R.Tabor@exeter.ac.uk

The MRL turbine was simulated with a free surface on the top of the domain which requires determining of the relative volume fraction of the two phases in a computational cell. A volume of fluid method was used, which is an efficient method for treating free boundaries as described by [3]. The simulations were carried out using a small scale MRL model with a diameter of $D = 0.20$ m.

Results and discussions

The results presented here are part of a wider investigation of turbine to turbine interactions in a tidal stream farm. The influence of two turbines (2 and 3) configured side by side to a base turbine (1) were considered for the analysis as shown in Fig. 1. The lateral spacing of the devices was at $2D$ (Fig. 1b) and $4D$ (Fig. 1c).

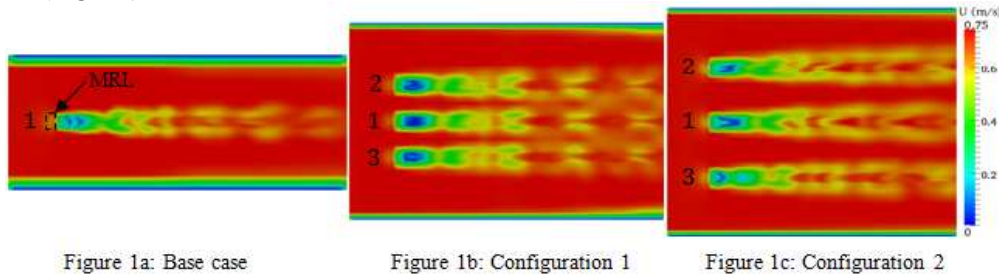

Figure 1: Velocity contours through the centreline of the turbine sliced in the XZ plane

The performance of turbine 1 in Fig. 1b was up by 1.6% while the same turbine in Fig. 1c was increased by 0.75% compared with the performance of the isolated turbine (Fig. 1a). This result showed that the influence of lateral turbines was positive and improved the performance of turbine 1 due to the blockage effect. The MRL turbine is designed to have high aspect ratio and this can create blockage effect when stretches across a stream flow, which might eventually improve its performance.

Fig. 1b showed physically larger wake downstream of the turbines compared to Figs. 1a and 1c which led to a net increase of the performance of turbine 1. However, there was a mixing of the wake in Fig. 1b which could affect the performance of downstream turbines. The mixing was minimised by increasing the lateral spacing (Fig. 1c) though the power output of turbine 1 was decreased compared to the same turbine in Fig. 1b. This might give a better space for deployment of additional turbines in staggered configuration and reduce the downstream length scale required in Fig. 1b to avoid wake interaction. In this way the overall net power output of a farm can be optimized.

Conclusions

The results showed that the performance of individual turbines in a farm can be improved with a small lateral spacing. However, due to the proximity of the turbines there was a mixing of the wake produced by each turbine. This could inflict significant energy shadowing to other turbines located downstream unless appropriate longitudinal spacing is used. An optimised location of the devices in a tidal stream farm could be therefore obtained by adding upstream and downstream rows of turbines which is currently under investigation.

References:

- [1] Janssen, A.P. and Belmont, M.R. (2009). Initial research phase of MRL turbine. Technical report, Technical Report N0: MO 562L, 2009.
- [2] Xie, Z. and Castro, I.P. (2006). LES and RANS for turbulent flow over arrays of wall-mounted obstacles. *J. Flow, turbulence and combustion*, **76(3)**: 291-312.
- [3] Hirt, C.W. and Nichols, B.D.. (1975). Volume of fluid (VOF) method for the dynamics of free boundaries* 1. *J. of computational physics*, **39(1)**: 201-225.

Near-field flow downstream of a barrage: Experiments and 3-D modelling

Penelope Jeffcoate*, Peter K. Stansby, David D. Apsley

*Department of Mechanical, Aerospace and Civil Engineering, University of Manchester,
M13 9PL, UK*

Summary: The effects of barrage implementation over large areas has been assessed using two-dimensional modelling^[1], however, in order to determine the effects of a barrage in the near-field 3-D assessment is required^[2]. Flume experiments, with three-component velocity measurements, and 3-D CFD modelling were conducted to assess the velocity variations throughout the flow downstream of a seven-duct barrage. The large velocity variations at different depth locations in the experimental results show that within 20 duct diameters (20D) of a barrage 3-D analysis is required. The CFD results also show flow variation across the depth, however, more jet spreading occurs than in experiments.

Introduction

A key problem perceived to arise from tidal barrages is the detrimental environmental impact; this may include changes in water levels, altered water turbidity and changes to sediment drift patterns. Previously two-dimensional (depth-averaged) computational modelling has been conducted to determine the effects of barrage implementation on an entire estuary or coastline^[1]; however the 3-D flow field close to the barrage requires analysis. In order to assess the hydrodynamic effect of tidal barrage implementation, flume experiments and 3-D computational modelling have been conducted.

Methods

A 1:143 scale model of a proposed Severn barrage^[3] was fitted in an experimental flume, with simplified cylindrical ducts and bulb turbines with fixed, angled stators. A Vectrino ADV was used to record the three-component velocities at various depths and distances downstream (Fig 1). A three-dimensional model of the upstream area, downstream area and the barrage ducts was created using StarCCM+; the experimental inlet conditions were applied to the model, including the upstream depth, downstream depths and inlet velocity. The bulb turbine and resulting swirl velocity in the CFD modelling were represented by an in-channel blockage and body force respectively. The experimental flow field was analysed using the velocity measurements and the effectiveness of 3-D computational modelling for predicting flow effects of barrages was determined.

Results

The three-component velocities downstream at 1 duct diameter (1D), 2D, 5D, 10D and 20D recorded in the experiments were analysed; the vertical and spanwise velocity vectors shown at 1D (Fig. 2) indicate the large rotational element of the velocities downstream from the ducts and the high variation of the velocity profiles throughout the depth. This variation throughout the depth is evident up to 10D from the barrage; however, at 20D from the barrage the velocity profiles are more uniform. This is most evident in the U_y and U_z components of

* Corresponding author.

Email address: Penelope.jeffcoate@postgrad.manchester.ac.uk

the velocity, although, there are large variations in the U_x profiles within 2D of the barrage. The StarCCM+ model produced similar velocity vectors, with high rotation close to the barrage and variation in the velocities throughout the depth close to the barrage. The mid-height velocity vectors produced are shown in Figure 3; these show the acceleration of the flow through the ducts and past the turbine blockage. Both methods show a wake forming directly downstream from the bulb body, with jets forming either side of the duct. The jets can be seen to merge as distance from the ducts increases; however, the merging in the CFD results is much higher than that shown in the experiments, so refinement of the CFD model is required.

Conclusions

Within 20D of the barrage 3-D assessment is required in order to accurately determine the flow field downstream from a barrage. Both experimental and computational assessments showed high levels of swirl close to the barrage and flow circulation within 10D of the barrage, but the overestimated jet merging of the 3-D CFD results should be improved. The experimental results can be used for further analysis of the velocity profiles, swirl produced by the stators and the close-to-bed velocities, and thus provide input into scour and sediment transport modelling.

References:

- [1] Burrows R. Walkington I.A. Yates N.C. Hedges T.S. Wolf J. Holt J. (2009a) *The Tidal Range Energy Potential of the West Coast of the United Kingdom*. *App Ocean Res* **31**(4), 229-238
- [2] Jeffcoate P. Stansby P.K. Apsley D.D. (2011) *Near-field modelling of a barrage: experiments, 3-D CFD and depth-averaged modelling*. *Proc. of Conf. on Ocean, Offshore and Arctic Eng.* **5**, 909-918
- [3] Department of Energy (1981) *Tidal Power from the Severn Estuary*. DEP Energy Paper **46**, 198

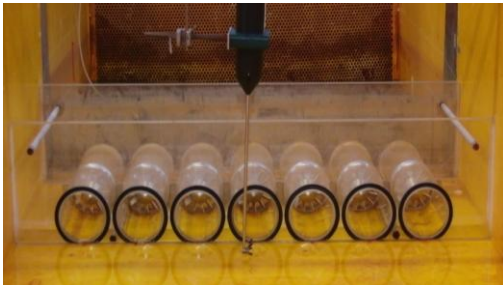

Fig. 1. Experimental barrage with Vectrino ADV

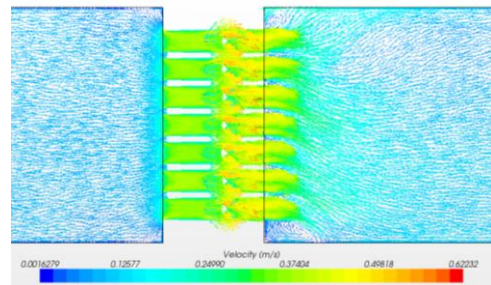

Fig. 3. StarCCM+ velocity vectors at duct mid-height

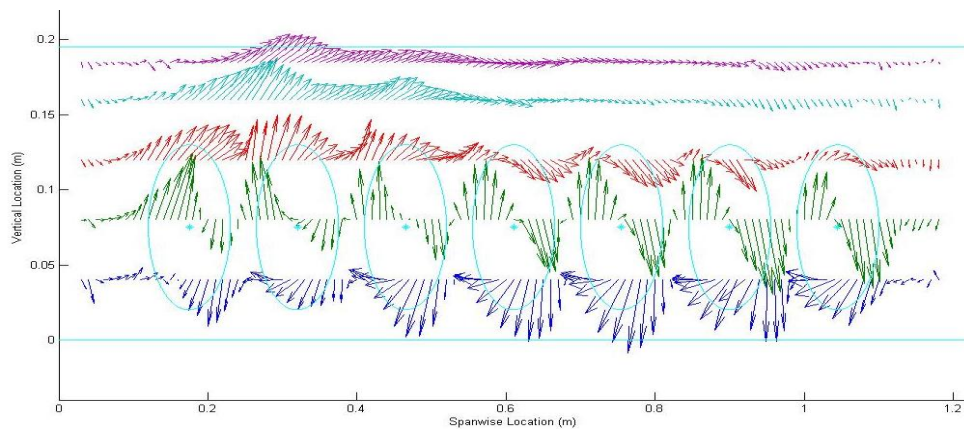

Fig. 2. Experimental vertical and span-wise velocity vectors at 1D downstream from barrage

Sediment dynamics in the wake of a tidal current turbine

Lada Vybulkova¹, Marco Vezza
*School of Engineering, University of Glasgow, G12 8QQ,
United Kingdom*

Harshinie Karunaratna
*School of Engineering, Swansea University, SA2 8PP,
United Kingdom*

Richard E. Brown
*Department of Mechanical and Aerospace Engineering,
University of Strathclyde, G1 1XJ,
United Kingdom*

Summary: One of the most important aspects of the environmental impact of tidal current turbines (TCTs) is their effect on the dynamics of the suspended sediment load. High resolution computational simulations of the hydrodynamics of a TCT have thus been conducted using the Vorticity Transport Model (VTM) together with a model for the erosion of the seabed downstream from the turbine. The present study shows that the high vortex-induced velocities in the wake of the turbine can cause elevated local bed erosion.

Introduction

The environmental impact of devices designed to extract power from tidal currents has yet to be thoroughly investigated. The interaction between the wake that is produced downstream of tidal current turbines (TCTs) and the sediment on the seabed is of particular concern given the damage that might be caused to the habitat of marine plants and animals that dwell on the ocean floor. High resolution computational simulations of the hydrodynamics of a TCT and its wake have been conducted using the Vorticity Transport Model (VTM) [1] together with a model for the uplift of sediment from the seabed and its subsequent transport downstream of the turbine. These simulations show the effect of the small-scale, highly intense vortical structures within the wake of the turbine in creating patches of locally-elevated shear stress on the seabed in which sediment uplift is enhanced. The effect of the turbine on the sediment near the seabed is shown to be strongly dependent on the parameters of the device, such as the blade twist distribution, and corresponding power produced by the turbine, but is also influenced by the natural instability within the wake that acts to destroy the coherence of its fine-scale structure some distance downstream of the turbine. These findings suggest that the design of TCTs for deployment in regions with significant sediment mobility needs to be considered with some care regarding their impact on the seabed.

Methods

High-resolution computer simulations have been conducted using the Vorticity Transport Model (VTM) for various blade twist distributions. The VTM provides a particularly accurate representation of the vorticity dynamics within a rotor wake, and has been used to study the influence of the wake on helicopter performance and, more recently, wind turbine efficiency, and can include the interactions of the wake with a ground plane. The VTM calculates vorticity and velocity of an incompressible fluid, solving the *Vorticity Transport Equation* [2]

¹ PhD Candidate.

Email address: l.vybulkova.1@research.gla.ac.uk

$$\frac{\partial \omega}{\partial t} + (\mathbf{v} \cdot \nabla) \omega - (\omega \cdot \nabla) \mathbf{v} = S_{\omega} + \nu \nabla^2 \omega \quad (1)$$

where the vorticity field is defined as curl of the velocity field.

The vorticity source term in (1) represents the shed and trailed vorticity arising from the lifting surfaces immersed within the flow. The effect of the ground on the wake in the VTM has been modelled using the *method of images* [3].

A critical bed shear stress is used as the threshold condition for initiation of sediment motion. The rate at which sediment moves into suspension (the erosion flux) is taken to depend linearly on the excess bed shear stress $(\tau - \tau_c)/\tau_c$.

Results

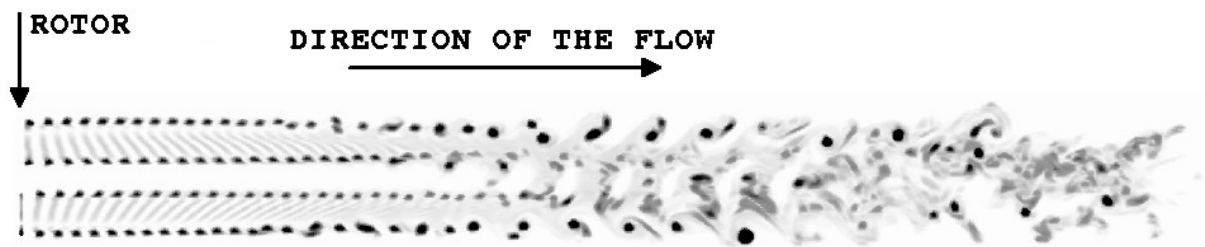

Fig. 1. Slice through the wake vorticity field

The VTM simulations have predicted qualitative differences between the wakes, the scale of sediment pick-up rates and power coefficients for a range of blade twist distributions of a TCT. A slice through the magnitude of the wake vorticity field - Figure 1 shows instabilities in the wake. The power coefficients of the chosen twist distributions are given in Table 1.

Twist	TW1	TW2	TW3
Power coefficient	0.10	0.11	0.12

Table 1. Power coefficients

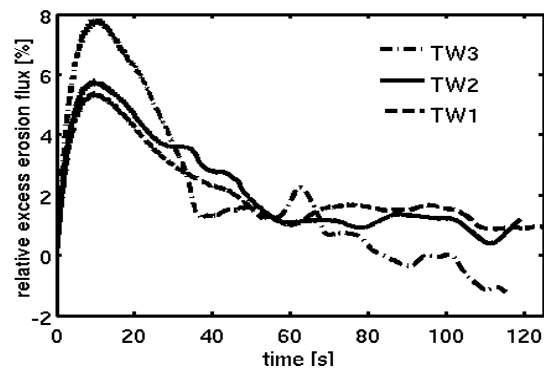

Fig. 2. Relative Excess Erosion Flux

The relative excess erosion flux evolution on Figure 2 represents an amount of sediment eroded from the seabed relative to the amount of sediment eroded by a free stream.

Conclusions

A subtle change in the blade twist distribution can result in substantially different behavior of the wake of a TCT. Further research is to be conducted to better understand the ways in which the details of the design of a TCT can influence its impact on the ocean floor.

References:

- [1] Brown, R.E., and Line, A.J. (2005). "Efficient High-Resolution Wake Modelling Using the Vortex Transport Equation," *AIAA Journal*, Vol.43, No.7, pp. 1434-1443.
- [2] Line, A.J. (2004). *Computational Modelling of Helicopter High-Frequency Dynamics*, PhD thesis, Glasgow University.
- [3] Whitehouse, G.R and Brown, R.E. (2004) "Modelling Rotor Wakes in Ground Effect", *Journal of the American Helicopter Society*, Vol.49 (3), pp. 238-249

A cross-flow device with an oval blade path: predictions and measurements of blade forces

Peter B Johnson^{1,2}, Adam Wojcik¹, Kevin Drake¹.

1. *Department of Mechanical Engineering, University College London, WC1E 7JE, UK*

2. *School of Engineering, Nazarbayev University, Astana, Kazakhstan*

Summary: A cross-flow device is proposed with an oval blade path (two straight lines joined by two semi-circles). Unlike axial flow devices, the capacity of such a device is not limited by water depth. Hydrodynamic performance of the device is predicted with a two-dimensional vortex model and compared to two-axis blade force measurements from a lab-scale experimental device. There is some encouraging agreement, and improvements to the numerical model are suggested.

Introduction

A cross-flow tidal stream energy device is proposed where the blades follow an oval path, in particular the limiting case where the oval path consists of two straight lines joined by two semi-circles. The motive is to develop a device with high hydrodynamic efficiencies and also the ability to be built on very large scales because, unlike axial-flow rotors, the device can be made wider without needing an increase in water depth. In the absence of a convenient acronym the device is named the ‘Moonraker’. The focus of the present research is on the hydrodynamics of such a device, defined here as the forces exerted by a flowing fluid on the blades during a representative revolution.

Methods

A two-dimensional point vortex model was implemented in Matlab according to the method of [1] and modified to accommodate an oval blade path. The circulation about the blades is determined from empirical data ([2] at large scale and [3] for lab-scale) and the Kutta-Joukowski relation.

A dynamic stall model has not been implemented, though this should be included in future models as per [1]. Ideally a three-dimensional model (also introduced by [1]) would be used, however while its implementation is incomplete the best remedy for this is to correct blade forces for the effects of tip vortices. The vortex model predicts that at large scale the Moonraker can achieve high power coefficients (see Fig. 1).

A lab-scale prototype of the Moonraker was constructed (see Fig. 2) and tested in the towing tanks at UCL and at QinetiQ (where blockage was 1.5%). One blade was instrumented with a two-axis load cell which was built in-house at UCL. The blade, which is

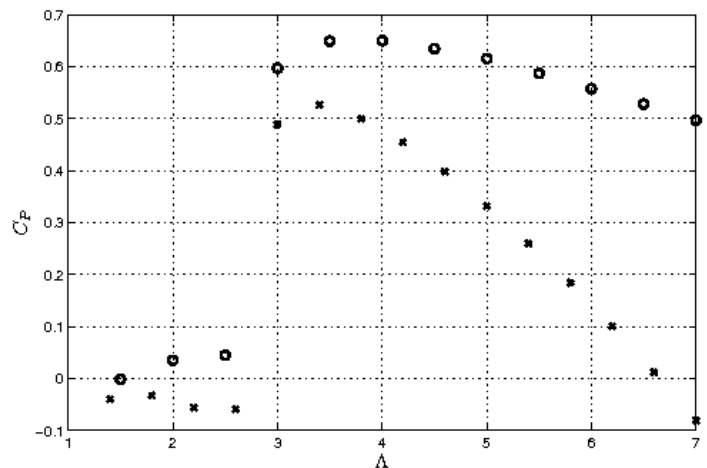

Fig. 1. Power coef., C_p vs blade speed ratio, Λ from vortex model of large scale Moonraker. The Betz limit is exceeded by using two rows of blades.
(o) Infinite blade length (x) AR = span/chord = 20

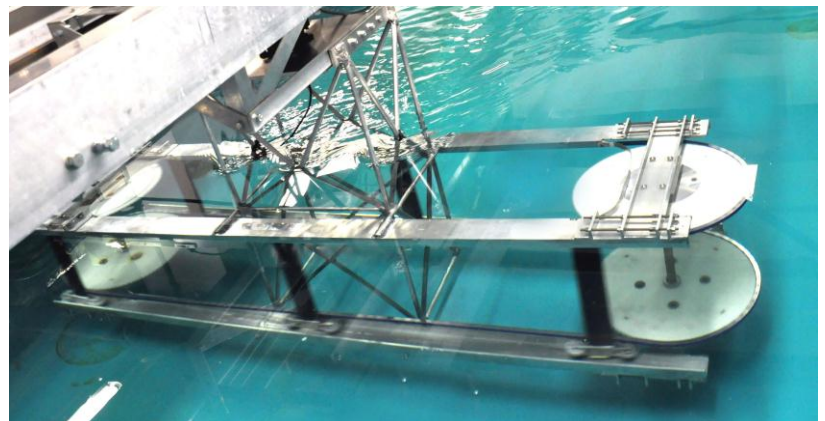

Fig. 2. Prototype Moonraker in the UCL towing tank

hollow carbon fibre, was split in two at the centre and re-joined with a stainless steel beam; a pair of straining gauges was attached to each of the four sides of the rectangular cross-section of the beam.

Results

Figure 3 shows an example of experimental results from QinetiQ, showing the component of force on the blade normal to its motion, as compared to predictions. There is good agreement except for the aspects annotated on the figure. The clipping is due to the non-symmetric range of the load cell (as a result of stray resistance in the circuit). There are some oscillations about the mean on the downstream side, potentially due to turbulence created by the structure.

Tangential forces showed high power coefficients in some cases, though this component of force measurement has a higher uncertainty. Agreement with the vortex model for tangential forces was poor, probably due to the difficulty of predicting drag at low Reynolds number, which ranged from 40,000 to 120,000.

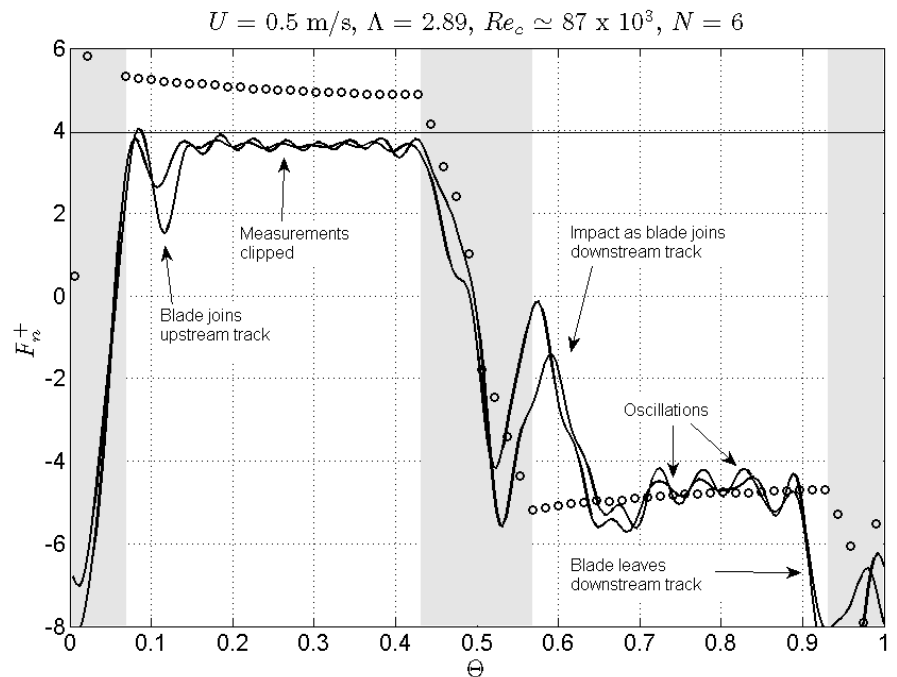

Fig. 3. Dimensionless normal forces on a blade over one revolution, plotted against normalised azimuth, Θ (upstream pass on the left, downstream pass on the right, with grey areas indicating regions where blades follow a curved path).

(-) Fourier averaged measurements from two independent towing experiments
(o) vortex model,

Conclusions

The hydrodynamics of a cross-flow device with an oval blade path have been investigated. Predictions of blade forces using a point-vortex model were compared to experimental measurements on a lab-scale prototype using an instrumented blade to measure two-axis forces. Results show some good agreement in terms of the force normal to the blade's motion, while agreement is not good for the tangential force. In future the vortex model should be extended to three-dimensions and should include a dynamic stall model. Further, experiments at a higher Reynolds number would be valuable.

Acknowledgements:

This work was funded by EPSRC and NESTA. Thanks to Sinan Hasan for his help with experiments.

References:

- [1] Strickland, J.H., Smith, T. and Sun, K. (1981), A Vortex Model of the Darrieus Turbine: An Analytical and Experimental Study. *Report No. SAND81-7017*. Sandia National Laboratories
- [2] Sheldahl, R. E., Klimas, P. C. and Feltz, L. V. (1980) Aerodynamic characteristics of seven symmetrical airfoil sections through 180-degree angle of attack for use in aerodynamic analysis of vertical axis wind turbines. *Report No. SAND80-2114*. Sandia National Laboratories
- [3] Althaus, D. (1980). *Profilpolaren fur den Modellflug*. Neekar-Verlag

Are Nearly all Tidal Stream Turbines Designs Wrong?

Stephen Salter

Institute for Energy Systems, School of Engineering, University of Edinburgh EH9 3JL.

Summary: There were many possible options for onshore wind turbines but the three-bladed axial-flow horizontal-axis design with a mono-tube tower is now universal. It is therefore not surprising that nearly all of the proposals for tidal-stream turbines use horizontal-axis axial-flow. The widely separated rotors are the equivalent of leaky pipes in a hydro-electric scheme. This paper attempts to show that, despite its widespread popularity, the transfer from wind technology is wrong and that a cross-flow design [1] with rotation about a vertical axis [2] is better.

Introduction

Calculating the forces on a turbine blade needs information about the angle of incidence of the flow which changes steadily along the span of an axial-flow machine. Many of the papers (eg. [3] [4]) at the 2011 EWTEC conference concerned turbulence in the turbine wakes. Flow is blocked around the hub and accelerated in the region outside the tips. Conventional machines must be placed a long distance downstream to avoid the problem.

A vertical cross-flow design

Flow conditions can be made the same everywhere with the vertical-axis, cross-flow configuration using close-packed rotors fitted with variable-pitch blades. Rectangles can fill a higher fraction of the channel cross-section than circles. A high blockage-ratio allows them to exceed the Betz limit in the high impedance flows that are found in long channels with rough seabeds.

Very large downstream forces are transmitted to the sea bed with a tri-link mechanism which is free in pitch, roll and heave, which suffers no bending moments and which allows self-installation and electrical connection to pre-placed attachment points with a post-tensioned rock interface on the seabed. The links are made from post-tensioned concrete which is highly resistant to fatigue. Link buoyancy can be adjusted to make links float or just sink. The tri-link arrangement requires the rotor diameter to be at least twice the channel depth but allows the use of a large fraction of that depth. It gives swept rotor areas of 7000 square metres and peak power ratings of 70 MW in the Pentland Firth. The lines of action of the links are in planes passing through the centre of pressure so that the downstream force does not induce pitch or roll. The large diameter makes the system stable in these degrees of freedom but the rotor is able to follow tidal rise and fall. Hydraulic rams at the lower ends of the tri-links assist connection and disconnection, reduce extreme wave loads and even allow some power generation from waves which can be compared favourably with that from some nameless wave energy devices.

Rim power take-off at the full rotor diameter keeps the velocity into the power-conversion system as high as allowed by cavitation. High velocity means lower force. Digital hydraulic technology with poppet-valve control of displacement gives correct tip-speed ratio combined with true synchronous-generation, energy storage and a zero-stiffness rotor coupling. The full-diameter ring-cam pump will act as a geometrically-tolerant bearing. The vertical axis allows the use of a non-contacting gutter seal providing dry, clean operating conditions and shirtsleeve access to generating plant, even while on load. A large number (60 plus) of variable-pitch blades will each be shorter than the typical eddy size. Blades have a constant cross-section, no twist and a chord small enough to be moved in an ISO sea-container. They will be supported at both ends by stream-lined rings which suppress tip vortices and provide plenty of space for the pitch-changing mechanism. Most of the components can be used in a rotor of any diameter and in water depths from 10 to 50 metres.

Support of the blades at both ends reduces bending stress by a factor of four compared with conventional cantilevered designs. Maximum bending stress is at mid-span, well away from maximum shear at the two ends. There is no levering up of bearing loads as in axial-flow machines. The blades stay at the same depth so there is no fatigue due to variations in hydrostatic pressure. Measurement of the blade pitch-torque and relative water velocity provides all the information needed for control. The blades can present the correct pitch-angles for flow from any direction and are not affected by vertical velocity-shear. Changing pitch angle can limit fluid-loading forces, clip unwanted power peaks with instant torque removal, present an extremely low drag during installation and give high bollard pull and high agility when the rotor is used as a propeller during installation. A line of contra-rotating units can leave a wake which is *less* turbulent than the incoming water flow so that further banks of rotors can be close, the size of the resource can be maximised and the lengths of cable connections minimized. A way to calculate the angles needed to present a constant pressure across the front of a turbine was given by Salter [5]. Results are shown below.

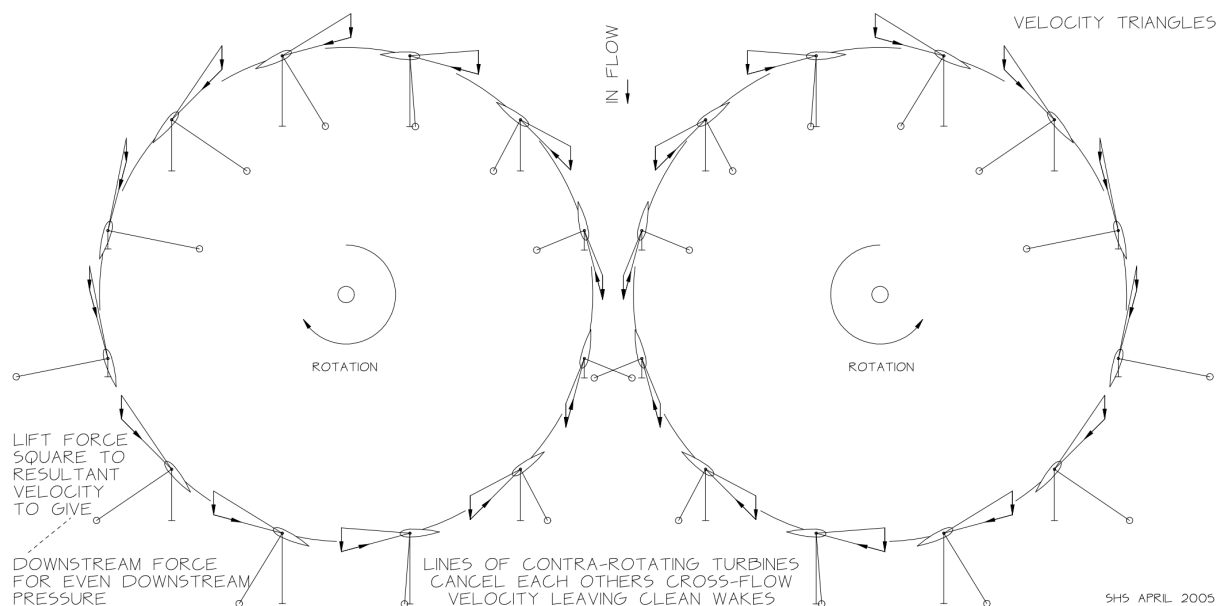

Figure 1. The downstream force for the required even pressure across the rotor is used to get the contribution for each turbine blade, the lift force perpendicular to the resultant velocity and so the blade pitch-angle.

Conclusion

The answer to the question in the title is yes.

References:

- [1] McAdam RA., Houlby GT., Oldfield MLG. Structural and Hydrodynamic Model Testing of the Transverse Horizontal Axis Water Turbine. EWTEC Southampton, September 2011.
- [2] Salter S. Taylor JRM., Vertical-Axis Tidal-Current Generators and the Pentland Firth. Proc.I.Mech.E. vol. 221 Part A. Journal of Power and Energy Special Issue paper pp.181-195.
- [3] Stallard T., Collings R., Feng T., Whelan JI. Interactions Between Tidal Turbine Wakes: Experimental Study of a Group of 3-Bladed Rotors. EWTEC Southampton, September 2011.
- [4] O'Doherty DM., Mason-Jones A., Morris C., O'Doherty T., Byrne C, Prickett PW. Grosvenor RI. Interaction of Marine Turbines in Close Proximity. EWTEC Southampton, September 2011
- [5] Salter SH. Pitch-Control for Vertical-Axis, Marine-Current Generators. World Renewable Energy Conference Aberdeen May 2005.

Experimental results from 1/20th scale model tests of the Transverse Horizontal Axis Water Turbine

Ross A. McAdam*, Guy T. Houlsby, Martin L.G. Oldfield
Department of Engineering Science, University of Oxford, OX1 3PJ, UK

Summary: In December 2010 and January 2011 a series of tests were carried out on 1/20th scale, 0.5m diameter, configurations of the Transverse Horizontal Axis Water Turbine (THAWT) in the combined wind, wave and current tank at Newcastle University. Measurements were made of the hydrodynamic and structural performance of the turbines, over a range of flow conditions. As well as producing conventional power and thrust curves for the experimental tests, the variation of blade loading is explored in order to understand and improve the fatigue resistance of the device.

Introduction

The THAWT device is a variant of a Darrieus turbine and has been proposed as an alternative design of tidal energy convertor, which can be more easily scaled by stretching the device across a channel. The turbine is configured with the rotation axis horizontal and perpendicular to the flow. The key feature of the turbine is that the blades are angled and connected to form a structurally stiff truss, which allows long stretches of multi-bay rotors to be constructed (Fig. 1(a)).

In December 2010 and January 2011 a series of tests were carried out on 0.5m diameter, configurations of the THAWT device in the combined wind, wave and current tank at Newcastle University. These tests were carried out to provide further verification of the hydrodynamic performance of the turbine and to provide detailed information on blade hydrodynamic loading, to allow structural design of a full scale turbine.

Test regime

Truss and parallel-bladed configurations of the THAWT device, each 0.5 m mean diameter and 1.5 m total length, were tested in the Newcastle flume (see Fig. 1), in Froude number flows between 0.10 and 0.18. The basic configuration for each device consisted of six blades and a rotor solidity of 0.25. The effect of blockage ratio on performance is investigated with experiments in flow depths of 0.8 m and 1.0 m. The variation of performance with both rotor solidity (number of blades), and blade fixed pitch angle has also been investigated for the parallel-blade configuration.

The speed of the turbine was steadily ramped in a quasi-steady fashion using a motor-generator with speed control, while the power produced was measured using a torque and speed sensor. The blade loads were measured in the truss and parallel configurations of the rotor using strain gauges at various locations along a blade, the signals from which were transmitted wirelessly from the rotating device (see Fig. 1(b)). Further details of the experimental setup and test regime can be found in [1].

Results

Due to the quasi-steady ramping of the rotor speed the power coefficient for each test can be calculated over the entire power curve as shown in Fig. 2(a). This power curve exhibits the usual bell curve shape. However, both configurations of rotor achieved power coefficients greater than the Lanchester-Betz limit, as a result of blockage effects [2]. Curves are also presented for the thrust coefficient of the device, which is necessary to understand the effect that the device has on the flow in future local and macro-scale modelling.

* Corresponding author.

Email address: ross.mcadam@eng.ox.ac.uk

Based on the measurements of bending moment along the blades, the distributed hydrodynamic load normal to the blade minor axis can be calculated during a rotation of the device, as shown in Fig. 2(b). The calculated blade loadings demonstrate that by utilising a high blockage, the flow through the device is significantly deflected and does not produce the symmetric loading that would be expected from a cross-flow device experiencing uniform flow. The significant metric in the blade loading is the range of the loading normal to the blade minor axis, which is the main driver of fatigue in the rotor and is anticipated to be the most likely failure mechanism.

Conclusions

The results from the experimental tests should allow a parameterised model of the THAWT device to be created, in which the power, thrust and blade loadings can be predicted at a specified set of device configuration, flow characteristics and tip speed ratio.

References:

- [1] McAdam, R. A., Houlby G. T., Oldfield M. L. G. (2011). Structural and Hydrodynamic Model Testing of the Transverse Horizontal Axis Water Turbine, *9th European Wave and Tidal Energy Conference*, Southampton.
- [2] Houlby, G. T., Draper, S., Oldfield, M. L. G. (2008). Application of linear momentum actuator disc theory to open channel flow. *Report No. OUEL 2296/08*, Department of Engineering Science, University of Oxford.

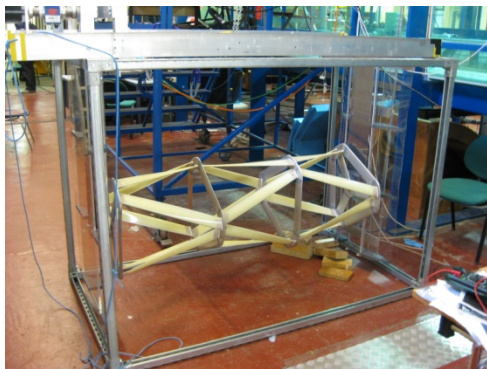

(a) Truss configured device on frame

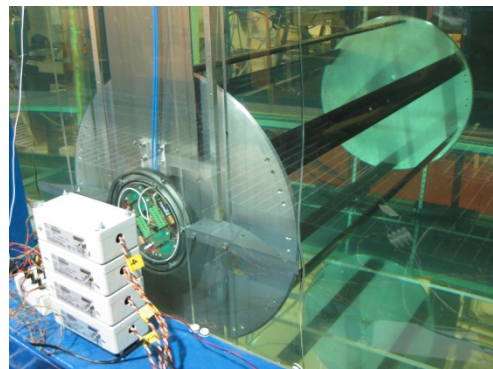

(b) Parallel configured device in flume

Fig. 1. Photographs of the two main configurations of rotor tested at Newcastle

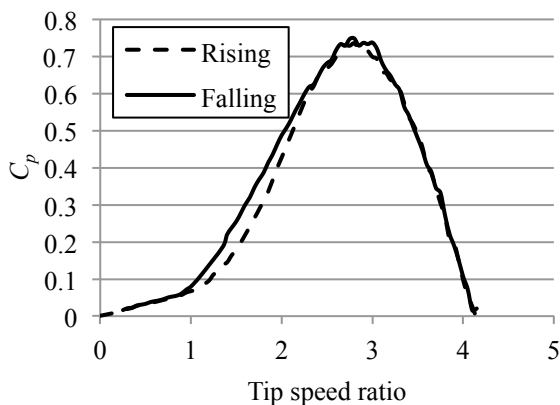

(a) Power coefficient versus tip speed ratio

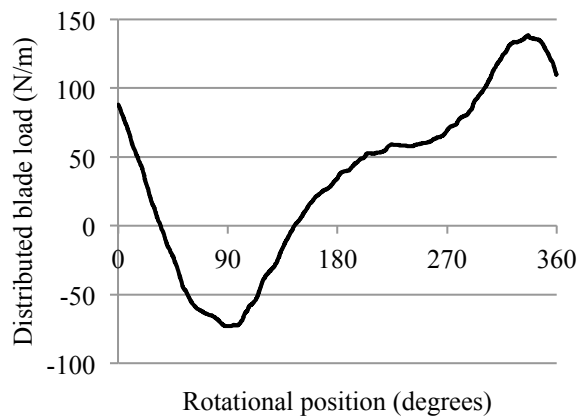

(b) Distributed blade loading at peak power

Fig. 2. Performance of the truss bladed device in 1m flow at a $Fr = 0.172$ and blockage ratio of 0.5

CFD Simulation of a 3-Bladed Horizontal Axis Tidal Stream Turbine using RANS and LES

J. McNaughton*, I. Afgan, D.D. Apsley, S. Rolfo, T. Stallard, P.K. Stansby
Modelling and Simulation Centre, School of MACE, The University of Manchester

Summary: Detailed 3D modelling of a tidal stream turbine (TST) is performed using a new sliding-mesh method implemented in EDF's open-source Computational Fluid Dynamics (CFD) solver, *Code_Saturne*. A two-equation transient Reynolds Averaged Navier Stokes (RANS) $k-\omega$ Shear Stress Transport (SST) model is used to study the flow-field for a range of tip-speed-ratios (TSR). The results are validated against the thrust and power coefficients of a laboratory scale experiment. Results are compared to a wall resolved Large Eddy Simulation (LES) which is carried out by other members of the research group.

Introduction

Full scale experimental measurements of TSTs and their wakes are both costly and extremely difficult to carry out which hinders the development and design process. The use of CFD allows for such tests to be carried out without these problems. The aims of this work is to investigate the possibility of using advance CFD to understand the flow physics and predict the behaviour of a TST under different operating conditions.

Methods

The flow around a three-bladed 0.8m diameter (D) TST with nacelle and mast has been numerically simulated using the $k-\omega$ SST model shown in Fig 1. The geometry matches the laboratory scale experiments carried out in a towing tank at the University of Southampton [2]. Wall-functions are used and so a near-wall cell spacing is used so that y^+ is in the range 20 – 100 at the blades. Several levels of mesh refinement are investigated with a final grid of 2.84 million cells. Calculations are performed using *Code_Saturne*, an open-source CFD code developed by EDF R&D [1]. *Code_Saturne* is a finite volume discretization with a co-located arrangement, able to deal with unstructured meshes. A new sliding-mesh method is implemented within *Code_Saturne* to allow for rotation of the TST within an outer domain. The simulation is first-order in time with 1.5° of rotation per time-step. The LES is, however, wall resolved ($y^+ < 10$ and mesh size 7 million) and uses a time-step around 100 times smaller owing to the mesh characteristics and second-order time-scheme.

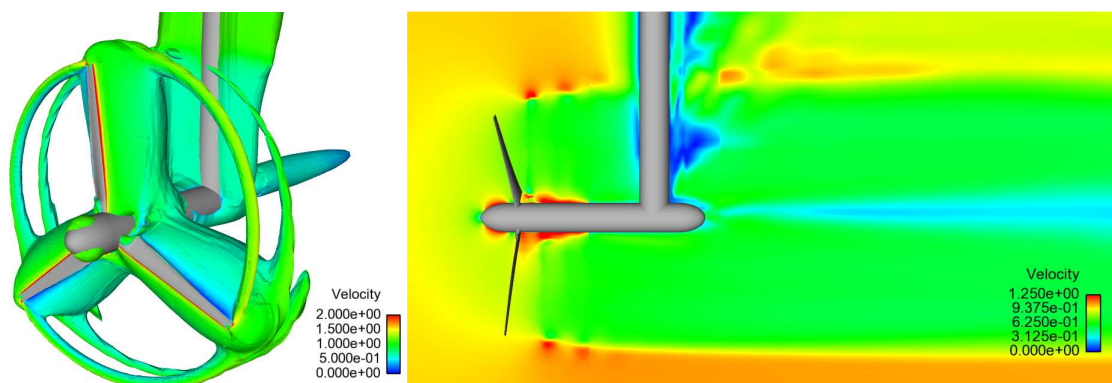

Fig. 1. Flow-field for the $k-\omega$ SST simulations. Left: Iso-surfaces of vorticity coloured by velocity magnitude. Right: Velocity plane through the domain.

* Corresponding author.
Email address: j.mcnaughton@live.co.uk

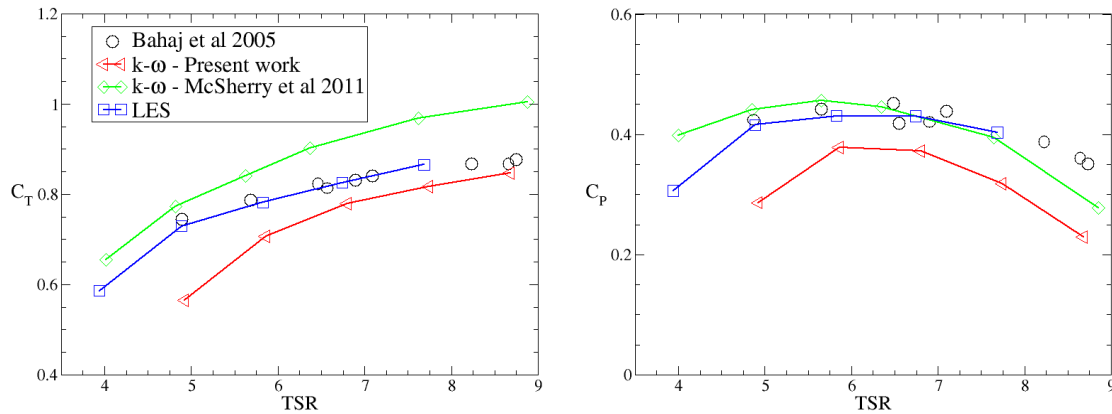

Fig. 2. Force coefficients at range of TSR for experimental, RANS and LES.

Results

Thrust, C_T , and power, C_P , coefficients are compared with the experiments of [2] for a range of TSR in Fig 2. The $k-\omega$ SST model under-predicts the force coefficients by around 10%. The LES calculations match the experimental values by around 3% throughout, except for the lower end of the TSR scale. No wake data is given from experimental measurements by [2] or numerical simulations of the same geometry by [3] and so comparison is drawn between the present RANS and LES predictions. CFX simulations are presented in [3] using the same turbulence model. These give closer prediction of C_P than the present work but over-predict C_T at the optimal $TSR \cong 6$. However, their analysis employs a coarse mesh which will not necessarily represent the flow physics accurately.

Conclusions

A sliding-mesh method is implemented in the open-source software, *Code_Saturne*. The $k-\omega$ SST model correctly predicts the force-coefficient curves. However, under-predicts the experimental values. An LES carried out as part of the project shows to increase accuracy of the results. This could be because of the difference in higher order time-scheme although this would require a significantly lower time-step.

Acknowledgements:

This research was performed as part of the Reliable Data Acquisition Platform for Tidal (ReDAPT) project commissioned and funded by the Energy Technologies Institute (ETI). The authors are highly grateful to EDF for additional funding and access to its High Performance Computing (HPC) facilities.

References:

- [1] Archambeau, F., Mechtoua, N., Sakiz, M. (2004). *Code_Saturne*: a finite volume code for the computation of turbulent incompressible flows-industrial applications. *International Journal on Finite Volumes*, **1**(1):1–62.
- [2] Bahaj, A. S., Batten, W.M.J., Molland, A.F., Chaplin, J.R. (2005). Experimental investigation into the effect of rotor blade sweep on the performance of the Marine Current Turbines. *Proceedings of the Institution of Mechanical Engineers, Part A: Journal of Power and Energy*, **215**(5):611–622.
- [3] Mcsherry, R., Grimwade, J., Jones, I., Mathias, S., Wells, A., Mateus, A., Ferguson House, E (2011). 3D CFD modelling of tidal turbine performance with validation against laboratory experiments. 2011.

Computational Modelling of Unsteady Rotor Effects

Duncan M. McNaë¹, J. Michael R. Graham
Department of Aeronautics, Imperial College London, SW7 2AZ, UK

Summary: Motivated by the importance of understanding the loads on tidal-stream turbine blades, the rotor response due to unsteady flow is analysed using numerical methods. The unsteady effect of particular interest is that of dynamic inflow, which is where changes in rotor state, results in changes in wake strength, which takes time to develop into a steady condition.

An implementation of the Vortex Lattice Method has been developed in order to determine the importance of this effect. Various test scenarios are modelled and the difference in transient induced velocity observed in each case is discussed.

Introduction

Tidal-stream turbines operate in a harsh marine environment, and can be subjected to significant flow fluctuations due to turbulence. Additionally, the requirements of suitable sites will often necessitate that the rotor is positioned near to the free surface, and hence will be subjected to velocity fluctuations as a result of passing waves [1]. These flow oscillations result in two characteristic turbine phenomena, that of dynamic inflow and added mass. Having an understanding of these dynamic effects is especially valuable for the fatigue design of the rotor blades, and also for control system models. Additionally, dynamic inflow becomes an important design factor when considering extreme events, due to the overshoot in loads that result.

It has been shown in some cases, such as in oscillatory flow, that dynamic inflow does not play a major role in the loads, which are predominantly in phase with velocity [2]. However in cases such as step changes in pitch or flow velocity, dynamic inflow has been shown to have a large effect [3]. The aim of this research is to gain an understanding of what causes this difference.

This study aims to interpret numerical simulations of unsteady flow situations, in order to further the understanding of dynamic inflow, and the effect it has on rotor loads in differing load cases. A Vortex Lattice Method has been used, which when compared to other numerical techniques, has the advantage that the solution attempts to find both the wake strength and shape, and hence also the the wake induced velocity. Additionally, the method requires less computational effort than CFD. The research demonstrates the relevance of the Vortex Lattice Method when considering dynamic effects in tidal-stream turbines.

Methods

A Vortex Lattice Method for rotor modelling has been realised in a computer simulation. The Vortex Lattice Method is an inviscid potential flow solver, with the blades represented at the camber surface. This method is validated against Theodorsen's Theory and Blade Element Momentum Method codes. A pictorial representation of the Vortex Lattice Method simulation is provided in Figure 1, where the shading is a function of circulation strength.

Various test cases are run on a rotor design that matches the experimental setup implemented by Whelan et al. [2]. A step change in blade pitch angle was compared with an equivalent step in change in flow velocity, representing a coherent gust. From the simulation, various quantities such as wake induced velocity on the rotor disk can be determined. Through the analysis of these factors, the effect of dynamic inflow can be observed.

The numerical analysis will be augmented with comparable experimental work, undertaken in a recirculating water flume equipped with a towing carriage.

¹ Corresponding author.

Email address: d.mcnae09@imperial.ac.uk

Results

Different authors have shown that step changes in blade pitch angle produce a much greater dynamic inflow effect, and therefore much larger load overshoots [3]. This is what was observed with the application of the Vortex Lattice Method, as the load overshoot for step increase in flow velocity is noticeably smaller.

Conclusions

The differences in dynamic inflow effect that are predicted by previous studies have been qualitatively realised in the numerical computations. Additionally, the added mass effect appears to be small, agreeing with the much of the literature on rotors in unsteady flow.

References:

- [1] Carbon Trust (2005). *UK tidal stream resource assessment (Phase II)*. Black and Veatch Ltd,
- [2] Whelan, J. I., Graham, J. M. R., Peiró, J. (2009). Inertia Effects on Horizontal Axis Tidal-Stream Turbines, *In: Proc. 8th European Wave and Tidal Energy Conference*.
- [3] Snel, H., Schepers, J. G. (1992). Engineering moles for dynamic inflow phenomena, *Journal of Wind Engineering and Industrial Aerodynamics*. **39**, 267-281.

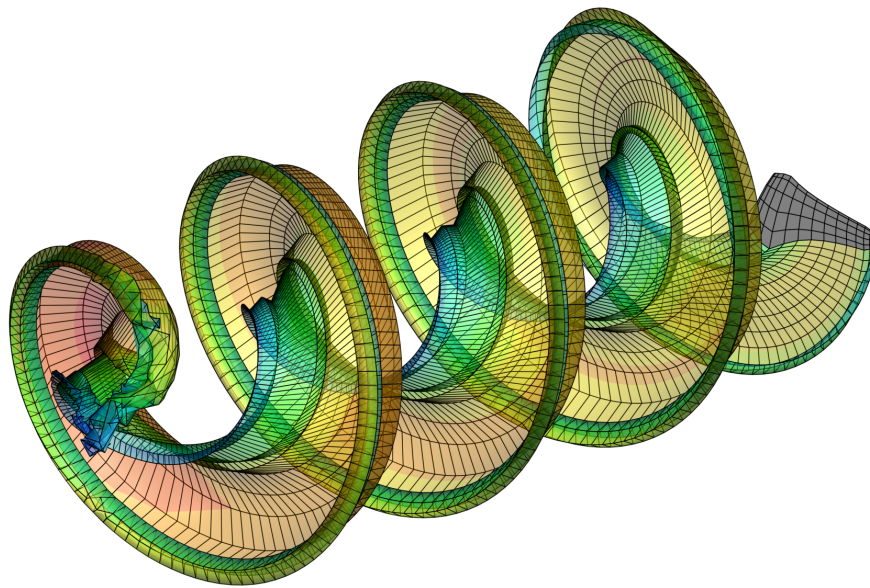

Figure 1. 3D representation of vortex lattice solver, one blade and its wake removed for clarity, shading is a function of circulation.

Development of an Actuator Line Model for Tidal Turbine Simulations

Justine Schluntz*, Richard H. J. Willden

Department of Engineering Science, University of Oxford, OX1 3PJ, UK

Summary: The paper presents a RANS embedded actuator line model for the simulation of tidal turbine rotor flows. The method enables time resolved flow simulations at considerably less expense than blade resolved simulations, whilst enabling modelling of discrete blade effects. The method is developed for use on unstructured grids, thus permitting simulation of ancillary turbine geometries, e.g. nacelles. Further, the method is developed to allow for arbitrary blade motion and turbine type.

Introduction

Various rotor modelling techniques exist in which the rotor can be modelled in a time averaged sense using either an actuator disk or a Blade Element Momentum (BEM) representation. Alternatively, time resolved models are available through either complete modelling of the blade resolved flow field or through the use of an actuator line method. In the actuator line method the rotor blades are approximated by point forces applied at the quarter-chord and distributed along the span of each blade (Figure 1). The actuator lines move in time, enabling an unsteady flow solution. Actuator line models allow for the effects on the flow due to the presence of discrete blades to be modelled without requiring the discretisation of the blade boundary layer, thereby increasing the speed of the computation as compared to blade-resolved models. Unlike RANS embedded actuator disc and BEM models, the time-dependent influences of the blades are directly included in actuator line simulations.

Sorensen and Shen [1] developed an actuator line model for use in horizontal-axis wind turbine simulations. Churchfield et al. [2] used a similar model in an investigation of tidal turbine arrays. These simulations, however, have been restricted to rotors in structured local polar grids. This type of grid is unsuitable for including the presence of stationary turbine components such as the shaft and nacelle. The objective of the present work is to develop a model that is adapted for unstructured grids, thus enabling arbitrary blade motion and the capacity to model a range of rotor types. Additionally the use of an unstructured grid enables the stationary turbine geometry to be explicitly meshed.

Methods

An actuator line model has been embedded in a commercial CFD solver, ANSYS FLUENT. The actuator line model may be viewed as an unsteady adaptation of BEM. As in BEM models, each rotor blade is split into spanwise segments and blade element theory is used to calculate the aerodynamic forces on each segment. Rather than average the influence of the blades over a revolution, however, the forces in an actuator line model are applied to the flow only along the blade quarter chords at the rotor's current position. The rotor position is then updated at the beginning of the following time step.

In each time-step, the forces on each segment of each actuator line are calculated using the local velocity at the segment's collocation point, the local angle of attack, and tabulated data for the aerodynamic coefficients. The force at the collocation point is then distributed to surrounding cell centroids in the finite volume fluid stencil. The Navier-Stokes equations are then solved taking account of the presence of the blades through the imposed forces along the actuator lines. The fluid and loading solution is then iterated until convergence before proceeding to the next time step.

Results

The concept of approximating a lifting surface using an actuator line was verified using a 3D elliptic wing. Computational results for the spanwise circulation distribution for a stationary elliptic wing

* Corresponding author.

Email address: justine.schluntz@eng.ox.ac.uk

were plotted against the analytical potential flow solution for both symmetric (Figure 2) and cambered wings over a range of angles of attack. The results compared favourably with the analytical solution for structured as well as unstructured grids. Initial results showed that the circulation near the wing tips was not as accurately reproduced as the circulation near the blade midspan, but this was improved upon by concentrating more collocation points in the vicinity of the tips. The test cases were run on both structured and unstructured grids.

Further work will include model validation against the NREL Phase VI wind tunnel test results. Representative simulations of rotating rotors will be presented at the workshop.

Conclusions

The actuator line method has been developed for use in an unsteady 3D simulation of one or more tidal turbines. The model has been adapted for use on an unstructured grid, allowing for stationary turbine geometry such as the nacelle and shaft to be explicitly included in the mesh.

Acknowledgements:

JS would like to thank the Rhodes Trust for supporting her doctoral research.

References:

- [1] Sorensen, J. N. And Shen, W. Z. (2002). Numerical modelling of wind turbine wakes. *J. Fluid Mech.* **124**, 393-399.
- [2] Churchfield, M. J., Li, Y., Moriarty, P. J. (2011). A large-eddy simulation study of wake propagation and power production in an array of tidal-current turbines. In: *Proc. 9th European Wave and Tidal Energy Conf*, Southampton.

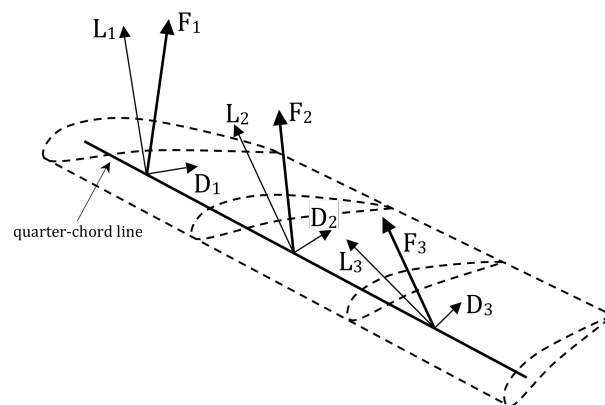

Fig. 1. Actuator line representation of a blade.

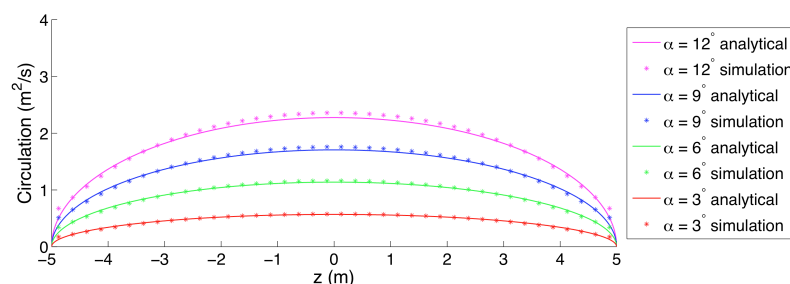

Fig. 2. Circulation distribution for a symmetric wing at varying angles of attack (structured grid).

Modification of Open Channel Flow By Opposing Waves

A. Olczak* and T. Stallard

School of Mechanical, Aerospace and Civil Engineering, University of Manchester, Manchester, M13 9PL

Summary: An experimental study is presented of the effect of waves on both the depth variation of mean velocity and turbulence characteristics of flow in a wide channel. The scale conditions considered represent a full-scale site of approximately 30 m depth with mean speed 3.8 m/s and wave periods of 8 - 16 s. Turbulence intensity and length scale are obtained representing fluctuations that are both turbulent and wave-induced. Preliminary comparison is drawn to full scale data from the European Marine Energy Centre tidal site [1], [2].

Background

To maximise energy extraction from tidal stream sites it is likely that turbines will be installed in arrays with devices at close proximity. Most of the potential sites are at exposed locations and waves and current coexist so it is important to understand the influence of waves on turbine and array design. Waves of long period such as swell waves influence flow velocity across the water column and so are expected to effect loading, power output, wake generation and the rate of wake expansion and recovery.

Methodology

A water depth of $h = 0.5$ m and mean flow speed $U = 0.46$ m/s is developed in a 5 m wide channel. Time varying velocities ($u_x(t)$, $u_y(t)$ and $u_z(t)$) are sampled at 200 Hz using a NORTEK Acoustic Doppler Velocimeter (ADV) Vectrino+. Flow is measured without waves and with the addition opposing regular waves of frequency 0.5Hz, 0.8Hz and 1Hz. A depth profile is recorded 6 m from the inlet on the centreline of the flume. For the flow only cases, samples of 5 min duration are recorded at 1 mm increments over the range $0.08 < z/h < 0.92$. For flow with opposing waves, samples of 1 min duration are recorded at seven depth increments. Mean velocity, \bar{U} , turbulence intensity, $TI_i = \bar{u}_i/\bar{U}_x$, and turbulence spectra (Figures 1 - 3) are obtained where \bar{u}_i is time-average of all fluctuations including wave induced. Length scales are obtained for each sample by auto correlation (Equation (1)) of each time-varying sample and, at mid-depth, by cross correlation of samples measured simultaneously at a range of increments.

$$L_i = \bar{U}_x \int_0^{\infty} R_i(t) dt \quad \text{where} \quad R_i(t) = \frac{\langle \overline{u_i(t)u_i(t+dt)} \rangle}{\langle \overline{u^2} \rangle} \quad (1)$$

Flow Characteristics

The stream wise velocity profile is found to exhibit a power law profile, $U_x(z) = U_{x,max}(z/h)^{1/n}$, with $n = 10.6$ (Figure 1(a)). This is a similar profile to full scale flow speeds of 0 - 0.4m/s. The depth averaged streamwise turbulence was found to be 12%, a similar magnitude to the turbulence reported at the EMEC tidal site ([2]). Anisotropy is also similar: ratio of 1:0.67:0.5 reported by [2] compared to 1:0.65:0.55. Streamwise turbulence length scale by Equation 1 was found to be 0.28 m at mid-depth but increases towards bed. This approach is sensitive to sample length but is in reasonable agreement with 0.245 m ($\sim 0.54h$) by cross correlation at mid depth. Lateral and vertical length scales are $L_y = 0.16$ and $L_z = 0.07$ m by Equation 1 and $L_y = 0.15$ m and $L_z = 0.12$ m by cross correlation. Smaller streamwise length scale of order of 11-14 m ($\sim h/4$) are reported by [2].

Opposing Waves

As expected co-generation of flow and opposing surface waves results in minimal change to the mean velocity profile. Both U_x and U_z are within the experimental scatter. A reduction in the lateral velocity U_y is also observed indicating that waves reduce the transverse circulation that develops within a wide channel.

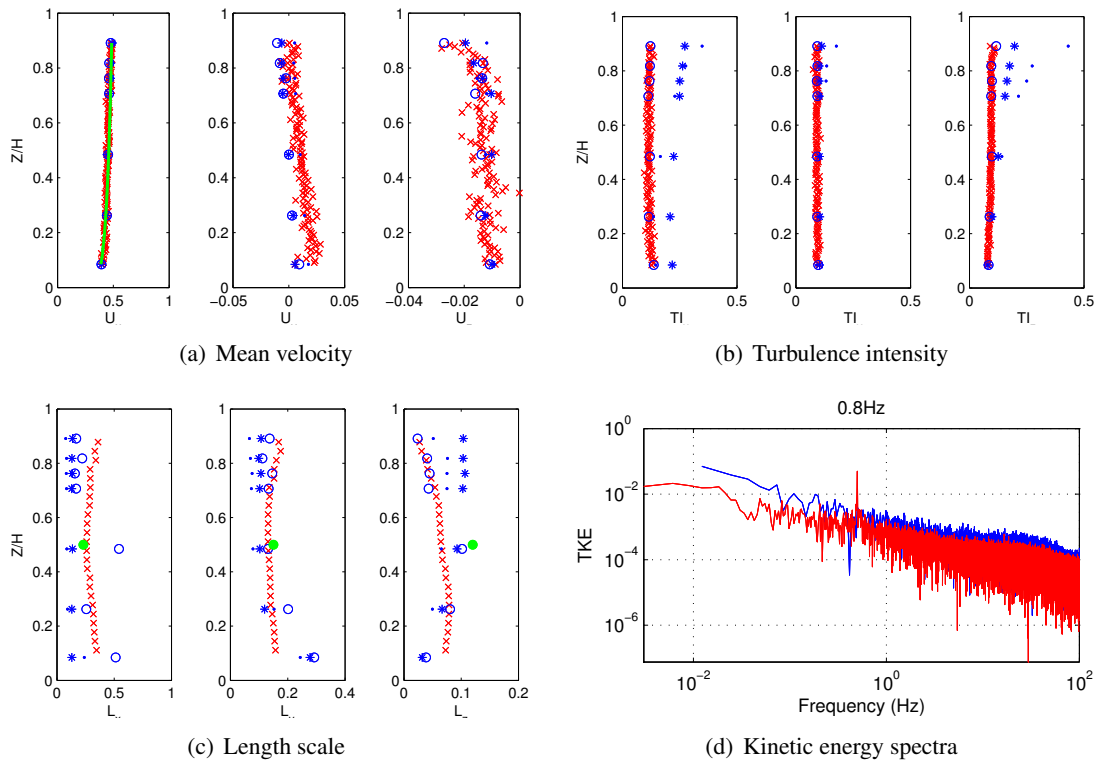

Figure 1: Depth profiles of (a) mean velocity, (b) turbulence intensity and (c) length scale, Equation 1, for uniform flow only (\times) and with opposing waves of 1 Hz (\circ), 0.8 Hz (\bullet) and 0.5 Hz ($*$). Green markers by cross correlation. Kinetic energy spectrum also shown (d) for $z/h = 0.5$ without and with waves of 0.8 Hz.

Wave induced kinematics appear as higher turbulence intensity, particularly close to the surface. Length scale is generally reduced reflecting the magnitude of wave induced oscillation.

Conclusion

Measurements are reported of turbulence characteristics in a wide channel and modification by opposing waves. Waves of 0.5 Hz increase the turbulence intensity throughout the water depth but only the upper third of the depth is influenced by higher wave frequencies. Integral length scales are modified throughout the water column but the Auto correlation method employed is found to be sensitive to sample length. Turbulence characteristics reported represent all flow- and wave-induced fluctuations. Analysis of turbulence fluctuations only is ongoing.

References

- [1] G. McCann, M. Thomson, and S. Hitchcock. Implications of Site-Specific Conditions on the Prediction of Loading and Power Performance of a Tidal Stream Device. In *2nd International Conference on Ocean Energy (ICOE 2008)*, October 2008.
- [2] I.A. Milne, R.N. Sharma, R.G.J Flay, and S. Bickerton. Characteristics of the Onset Flow Turbulence at a Tidal-Stream Power Site. *Proceedings 9th EWTEC, Southampton, UK. 5-9th September, 2011.*

Prediction and Measurement of Time-Varying Thrust on Tidal Turbine due to Mean and Oscillatory flow

Fernandez Rodriguez, E., Stallard, T. and Stansby, P.K.

School of Mechanical, Aerospace and Civil Engineering, University of Manchester, M13 9PL

Summary: The suitability of a blade element momentum method for predicting time-varying thrust due to both steady flow and opposing waves is assessed by comparison to experimental measurements obtained at small geometric scale. A blade element model is developed and validated for steady flow against published data for both a 0.8 m diameter rotor [1] and a 0.27 m diameter rotor [2]. Time-variation of angular speed, thrust and power are obtained for uniform flow only and flow combined with opposing waves. Comparison is drawn between measured time-varying thrust and predicted time-varying thrust based on flow velocity measured at hub height and assumed quasi-steady over intervals up to one-tenth of a wave period.

Blade Element Momentum Theory

Blade Element Momentum (BEM) Theory is widely used to obtain the variation of power coefficient (C_p) and axial thrust coefficient (C_T) with turbine's rotational speed (TSR). A turbine power curve is obtained by relating the lift and drag curves for each section of a blade to the net thrust and power developed by the rotor. Design software such as GH Bladed is widely used for both wind- and tidal stream turbine design. This approach has been shown to be suitable for prediction of performance of mean performance of tidal stream turbines [1, 2] although corrections for blockage may be required. There is less published information available concerning the suitability of this approach for prediction of time-varying thrust and power. This is particularly important for flows comprising both uniform flow and current for which there is uncertainty on the transient loads effects on the rotor. This research employs the BEM theory to predict in a quasi-steady state the turbine's unsteady behaviour.

Experimental Approach

The experimental arrangement is as described in [2]. A rotor of diameter $D=0.27$ m is supported on a strain gauged support structure and assisting or retarding torque applied by a custom dynamometer. Angular speed ω is obtained from an optical encoder. Torque is held constant in time at values of [0.0039-0.0156] N-m to attain tip-speed ratios over the range 4-6.5 in steady flow. The rotor is located at mid-depth and mid-span of a 5 m wide flume with water depth 0.45 m. The incident flow velocity, $u(t)$, is measured at hub height using a Nortek Vectrino+ ADV prior to rotor installation. All parameters are sampled at 200 Hz. The influence of oscillatory flow on the rotor performance is investigated by development of regular waves of 2 cm amplitude and frequency of 0.5 Hz opposing the mean flow. Mean axial velocity in the absence of waves is $\bar{u}_c = 0.462$ m/s. Axial velocity with waves varies from 0.66 to 0.23 m/s with a mean of $u_{c+w} = 0.442$ m/s.

Predicted and Measured Thrust

Accuracy of the present BEM implementation is demonstrated by comparison to published predictions from [1] and [2] and to measurements due to steady flow (Figure 1). Comparison is drawn between measured and predicted thrust ($F_{x,m}$ and $F_{x,p}$) assuming steady flow (averaged over $dt = 120$ s) and for time-varying flow (averaged over $dt = 0.1$ s). To facilitate comparison and because velocity measurements are not synchronized with thrust, the time-varying tip speed ratio (TSR) and thrust coefficient are normalized to the steady flow mean velocity for both measurements and predictions. From measurements:

$$TSR_m = \frac{\bar{\omega}_m(t)}{\bar{u}_c} \quad C_{T_m} = \frac{F_{xm}(t)}{0.5\rho A \bar{u}_c} \quad \text{Eq.1}$$

A fitted curve on the experimental average thrust coefficient graph at 20 Hz (Figure 2b) is employed in the model's prediction to obtain improved synchronized velocity and time varying thrust coefficients.

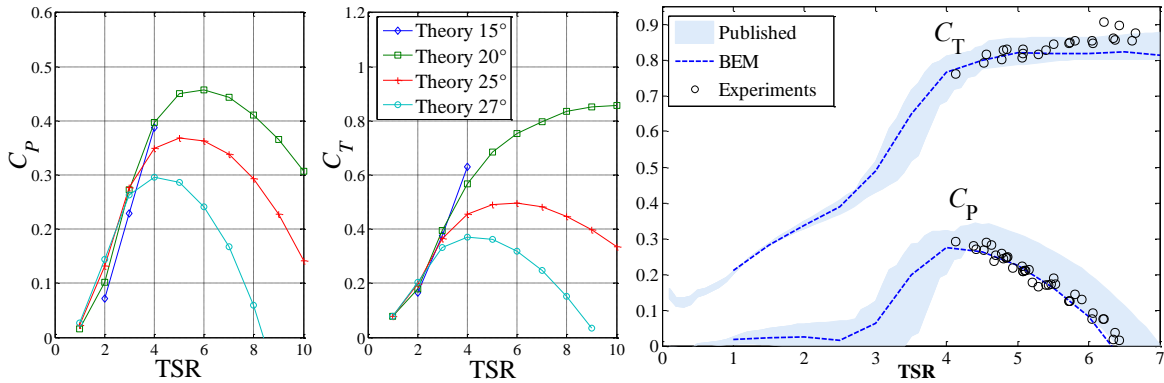

Figure 1: BEM predictions of thrust and power curves compared with published data [2] for range of pitch angles and (b) to published predictions [1] and experimental measurements.

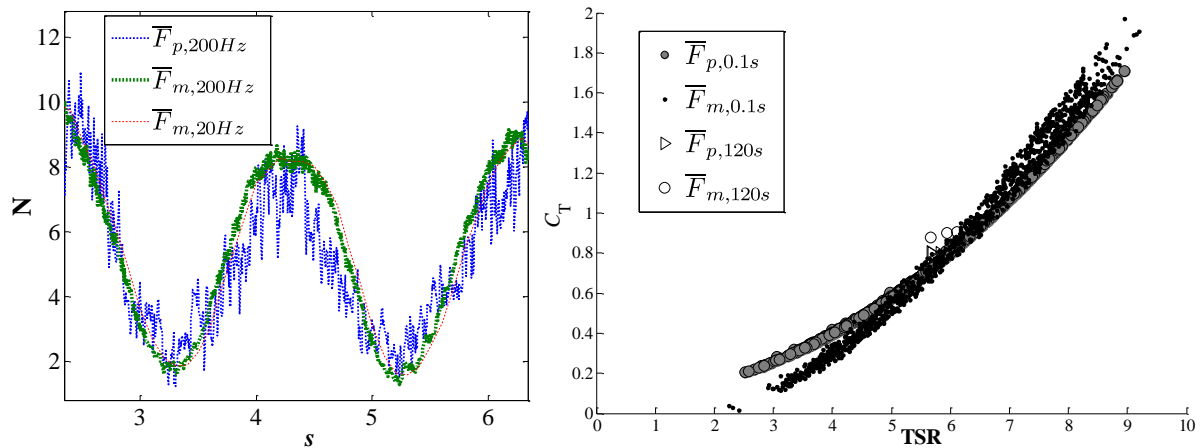

Figure 2: Example of time varying thrust force (a) during one minute sample with waves opposing mean flow and (b) the variation of thrust coefficient over each 0.1 s interval obtained from measurement and prediction. Both measurement and prediction normalised to mean flow of $u_c = 0.462$ m/s.

Conclusions

A BEM numerical code has been written and employed to predict time-varying thrust and power from a tidal stream rotor due to oscillatory flow developed by mean flow and opposing waves. Implementation has been verified against previous publications of two tidal stream turbines [1, 2] and additional experiments. The measured thrust coefficient is lower than predicted based on steady assumptions for low TSR and greater than predicted for high TSR. When averaged over a two-minute sample the average measured thrust coefficient is found to be greater than steady predictions by around 8-9 %. Ongoing work addresses the case of forced oscillation in steady flow to improve understanding of the effect of oscillating loads on performance.

References:

- [1] Batten, W. M. J., A. S. Bahaj, et al. (2008). "The prediction of the hydrodynamic performance of marine current turbines." *Renewable Energy* **33**(5): 1085-1096
- [2] Whelan, J. and T. Stallard (2011). Arguments for modifying the geometry of a scale model rotor. 9th European Wave and Tidal Energy Conference, . Southampton. 5-9 ,September 2011.

Blade Element Momentum Theory for Tidal Turbine Simulation with Wave Effects: A Validation Study

Hannah C. Buckland*, Ian Masters
College of Engineering, Swansea University, SA2 8PP, UK

James A. C. Orme
Swanturbines Ltd, Digital Technium, Singleton Park, Swansea, UK

Summary: The non-linear and three-dimensional effects of a regular wave and tidal dynamic inflow on a tidal stream turbine are important for performance optimisation and to determine survivability. A reactive coupling between Blade Element Momentum Theory (BEMT) and Chaplin's stream function wave theory is used as a simulation tool to determine turbine performance in dynamic inflow. The simulation is validated against a unique data set by Barltrop et al. [1] of a towed turbine in a wave climate. The comparison considers axial force and torque, providing validation of the BEMT scheme, the wave model and the wave frequency coupling between them.

Introduction

As the marine energy industry evolves from device design to deployment, fast and robust turbine computer simulations are needed to predict performance and survivability in varied fluid flow conditions. Within the MatLab computing environment, this scheme can successfully simulate tidal turbine performance with low computational time when compared to a more traditional CFD approach. The inclusion of loss corrections and wave theory adapts BEMT to model the performance of a real turbine and the scheme can be validated against experimental data.

Computational Methods

BEMT models the performance of a turbine by combining one-dimensional momentum theory with rotational momentum and blade element theory. In both cases, two sets of equations are obtained for the turbine axial force and torque. The system is resolved by using the least squares method for the difference between the complementing theories thus converging on an agreed solution. A complete derivation of these equations and verification of the model is given in [2].

The stream function wave theory describes a 2D periodic wave of permanent form in irrotational and incompressible flow. The frame of reference moves with wave speed reducing the problem to one of constant flow. The problem is defined in the same way as finite depth linear wave theory and similar boundary and flow conditions apply. Wave velocities are summed with the tidal velocities to give a combined flow velocity, stored in a velocity matrix. This can then be used to interpolate the incident flow velocity at the blade element position in blade element theory and the upstream flow velocity for momentum theory. The accelerative terms calculated from stream function wave theory are retained as they produce hydrodynamic force on the turbines which is calculated from Morison's equation, [3].

BEMT assumes a fully developed wake, steady state, at each iteration therefore the number of iterations is kept high. Wave and tidal flows do not act independently of each other. This model cannot capture the rotation of flow which may occur and the effect of the current velocity on the dispersion of the waves, [2]. An improved wave and tidal coupling theory is an active research area for the Marine Energy Research Group (MERG).

* Corresponding author.
Email address: 513924@swansea.ac.uk

Results

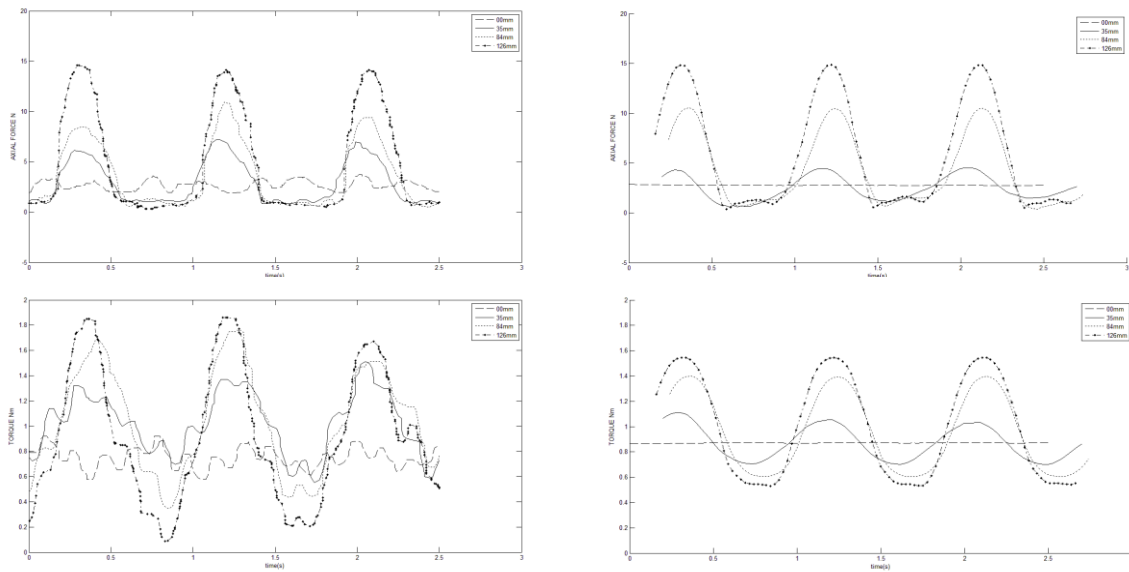

Barltrop et al. [1] investigate the axial force and torque for a 0.4m diameter turbine in a wave tank. The figure compares the experimental against computational results respectively with 90rpm rotational frequency, 0.7ms^{-1} current, in the presence of waves with frequency 0.833Hz and specified wave heights. The turbine was towed along the length towards a prescribed wave which was induced throughout the towing tank therefore realistic coupling between tides and waves is not captured. However, the apparent wave celerity will increase as the wave frequency seen by the turbine increases. A good agreement is observed between experimental data and the proposed scheme, with greater agreement in larger wave heights. This is due to a flow disturbance creating turbulent inflow, the effect of which is seen in the experimental results for no waves, in particular for torque. This disturbance is periodic and has a frequency of 9 per rev, implying that the 3 blades may be passing structures in turn. This blade pass disturbance becomes less significant with increasing wave height as the wave period begins to dominate the inflow velocities and accelerations.

Conclusions

An increased inflow velocity, with a fixed turbine rotational speed, always gives a decrease in TSR. The turbine reaction to this depends on the operating conditions and TSR. Therefore wave effects are dependent on the shape of the performance coefficient TSR curves around the operating condition of the turbine. Pitch, twist, chord length and aerofoil shape all impact on these TSR curve profiles. It is important that wave effects do not periodically stall the turbine and maximum axial force conditions are considered. The coupled BEMT scheme is proven to be a quick, simple and robust engineering tool suitable for predicting performance characteristics of real tidal turbines and is validated against experimental data. This extends the established BEMT turbine model to complex inflow problems and provides confirmation that steady state BEMT is still valid for dynamic flow conditions.

References:

- [1] Barltrop, N., Varyani, K. S., Grant, A., Clelland, D., Pham, X. P. (2007) Investigation into Wave-Current Interactions in Marine Current Turbines. *J. Power and Energy*. **221**, 233-242.
- [2] Masters, I., Orme, J. A. C., Willis, M., Chapman, J. (2010) A Robust Blade Element Momentum Theory Model for Tidal Stream Turbines including Tip and Hub Loss Corrections. In: *Proc. Institute of Marine Engineering, Science and Technology*, J. Marine engineering and technology. **10**, 25-35.
- [3] Orme, J. A. C. (2006) Dynamic Performance Modelling of Tidal Stream Turbines in Ocean Waves. *PhD Thesis, Civil and Computational Engineering, Swansea University*.

The Buhl High-Induction Correction for Blade Element Momentum Theory Applied to Tidal Stream Turbines

Ian Masters, Michael Togneri*
College of Engineering, Swansea University, SA2 8PP, UK

Summary: Blade element momentum theory (BEMT) is an extremely useful tool for simulation of turbines extracting power from a flow of fluid, but it is known to have difficulty making satisfactory predictions for turbines operating in significantly non-optimum conditions. One such case is that of the high-induction condition, wherein the axial momentum extracted from the fluid flow as it passes through the rotor disc exceeds some threshold. Several semi-empirical corrections have been proposed that attempt to rectify the BEMT treatment of this operating condition; in this work we examine a refinement of the Buhl correction, and validate results against experimental measurements [1] of a scale model turbine.

Outline

BEMT allows much more rapid simulation of tidal stream turbines (TSTs) than is possible with conventional CFD modelling. This rapidity is achieved by making several simplifying assumptions, not of all which are perfectly satisfied for all possible TST operating conditions. Two of these assumptions interact with one another to make the high-induction condition problematic: firstly, we imagine the fluid passing through the rotor disc as flowing through an enclosed streamtube. The second of these assumptions is made in the treatment of axial momentum flux through the rotor disc.

The extraction of kinetic energy from a fluid flow by a turbine decelerates the flow. In deriving the BEMT model we assume that this deceleration can be characterised by a single parameter $a(r)$, the ‘axial induction factor’, which varies with radial position r on the rotor disc. a relates the flow velocity in the far upstream (U_∞) to the velocity at the disc (U) and the velocity in the far wake (U_1) through the following equations:

$$\begin{aligned}U &= (1 - a)U_\infty \\U_1 &= (1 - 2a)U_\infty\end{aligned}$$

Clearly, if a exceeds 0.5, we have a reversal of flow in the far wake; equally clearly, this reversal is prohibited by continuity, since we have assumed a closed streamtube bounding the flow. A high-induction correction attempts to overcome the difficulties associated with these assumptions by adjusting the relationship between a and the axial thrust on the rotor disc. The Buhl correction assumes a quadratic relation between a and the axial force coefficient, C_{Fa} , above some critical value of a , conventionally 0.4; a more complete derivation of the theory is available in Chapman *et al.* [2]. This relationship is fully described by three parameters, obtained by matching the value and gradient of the corrected and uncorrected C_{Fa} - a curves at the critical value of a and by specifying the value of C_{Fa} at $a = 1$. The relationship between axial thrust coefficient and axial induction factor for classical BEMT, the Glauert high-induction correction and other correction scheme by Spera and Glauert is illustrated in figure 1.

Results

We have found that a BEMT model with a Buhl high-induction correction is able to satisfactorily predict the power output of a turbine by validation against experimental results. Predictions of axial

* Corresponding author.
Email address: M.Togneri@swansea.ac.uk

thrust, however, are less satisfactory, with the numerical model overpredicting thrust compared to measurements. Results from several simulations and from experimental work are shown in figure 2; more in-depth discussion of these results can be found in [2].

Acknowledgements:

This work was undertaken as part of the Low Carbon Research Institute Marine Consortium (www.lcrimarine.org). The Authors wish to acknowledge the financial support of the Welsh Assembly Government, the Higher Education Funding Council for Wales, the Welsh European Funding Office, and the European Regional Development Fund Convergence Programme.

References:

- [1] Tedds, S.C. *et al* (2011). Experimental Investigation of Horizontal Axis Tidal Stream Turbines. In: *Proc. of 9th EWTEC Conference*. Southampton, UK
- [2] Chapman, J.C.; Masters, I.; Togneri, M.; Orme, J.A.C. (2012). The Buhl correction factor applied to high induction conditions for tidal stream turbines. Submitted to *Renewable Energy*

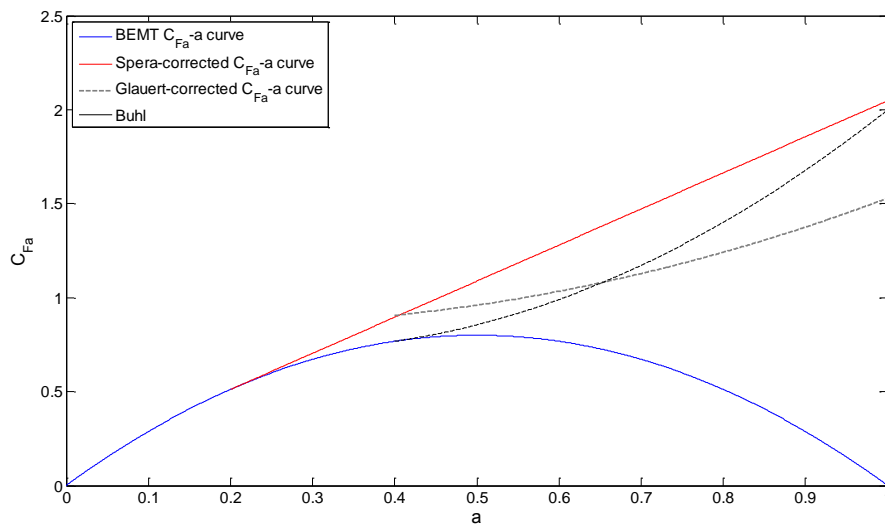

Figure 1: Relationship between axial induction factor and thrust coefficient for classical BEMT and a selection of high-induction correction schemes. Combined tip-hub loss factor of $F = 0.8$

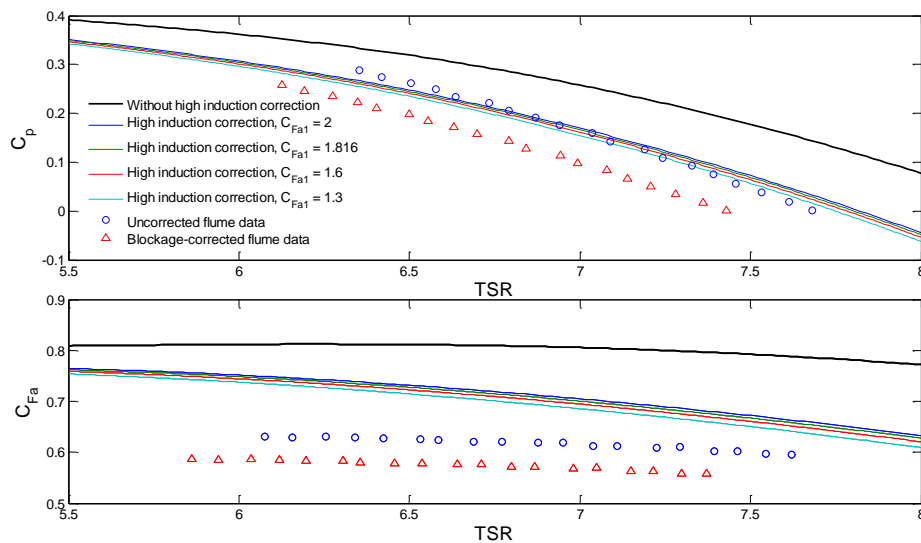

Figure 2: Comparison of numerical and experimental C_p and C_{Fa} values for a scale model of a TST operated in the high-induction regime.

Numerical Analysis of Open-Centre Ducted Tidal Turbines

Clarissa S. K. Belloni^{*}, Richard H. J. Willden & Guy T. Houlsby
Department of Engineering Science, University of Oxford, OX1 3PJ, UK

Summary: A computational study of open-centre tidal turbines using three-dimensional Reynolds Averaged Navier-Stokes simulations is presented. We investigate turbine performance, power and thrust, and relate these to the flow characteristics through the open-centre turbine. A substantial decrease in power is found relative to a bare turbine of the same external diameter. We also analyse the open-centre turbine in yawed flow. For yawed flow we observe an increase in power coefficient compared to the unyawed open-centre turbine which we attribute to increased effective blockage. The yawed open-centre turbine performs significantly poorer in terms of basin efficiency.

Introduction

One of the many concepts being pursued by the tidal stream energy industry is the open-centre ducted turbine featuring an aperture at the centre of the turbine disc. Manufacturers claim a performance benefit due to a speed-up effect generated by the duct as well as the jet flow through the turbine aperture [1, 2]. In this study we analyse the flow field and the efficiency of this type of device and compare it to that of an equivalent bare turbine [3].

Methods

We model the outer ducts as solid bodies and use porous discs to represent the turbine rotors, a simplification that greatly reduces computational complexity while capturing energy extraction and the primary interaction of the disc with the flow through and around the duct. The computational approach has been validated for bare turbines by comparison to Linear Momentum Actuator Disc Theory for turbines in arbitrarily blocked flows [3]. The topology of the open-centre turbine investigated is shown in figure 1. The channel dimensions were 75m x 75m x 290m, the turbine dimensions were $D = 16\text{m}$, resulting in an overall blockage of $B = 0.035$. Symmetry conditions were used for the upper, lower and lateral boundary conditions in the case of unyawed flow. And in the case of yawed flow periodic conditions were used on the lateral surfaces.

Results

We observe jetting flows through the opening at the centre of the turbine. We investigate the influence of aperture and observe an increase in pressure drop and flow velocity through the turbine disc with increasing aperture size, see figure 2. However, these increases, which increase the power generated per unit area of disc, are offset by the decrease in turbine disc area due to the increase in aperture size, thus resulting in an overall reduction in turbine performance with increasing aperture size, see figure 3.

For the open-centre turbine in yawed flow an increase in power coefficient is visible relative to that in unyawed flow. This increase in power coefficient can be attributed to the increased effective blockage of the device; the device is longer than its diameter and hence the projected area normal to the yawed flow direction is greater. Further the basin efficiency, defined as the ratio of useful power generated to total power removed from the flow field, of the yawed open-centre turbine is significantly lower than for the unyawed case due to large scale flow separations on the outer duct wall.

^{*} Corresponding author.

Email address: clarissa.belloni@eng.ox.ac.uk

Conclusions

For the open-centre turbine we present flow simulations and analyses for varying central aperture sizes. In all cases we find a flow jetting effect through the centre of the turbine. The effect of this jetting is outweighed by the decrease in rotor area, leading to a reduction in overall turbine performance with aperture size. Yawed flow is found to increase performance due to increased effective blockage, but at the expense of decreased basin efficiency.

Acknowledgements:

The authors would like to express their gratitude to the Engineering and Physical Sciences Research Council (EPSRC), Research Councils UK (RCUK), the German Academic Exchange Service (DAAD), and the Oxford Martin School which have partially funded this work.

References:

- [1] Clean Current Power Systems Incorporated. <http://www.cleancurrent.com/index.htm>, cited on 20 March, 2012
- [2] OpenHydro Group Ltd. <http://www.openhydro.com/home.html>, cited on 20 March, 2012.
- [3] C.S.K. Belloni, R.H.J. Willden (2011): "Flow Field and Performance Analysis of Bidirectional and Open-centre Ducted Tidal Turbines". In Proc. 9th European Wave and Tidal Energy Conference, Southampton, UK.

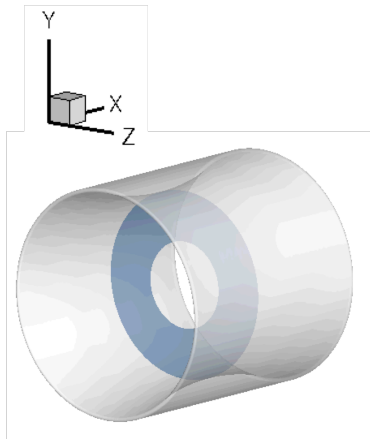

Fig. 1. The open-centre turbine.

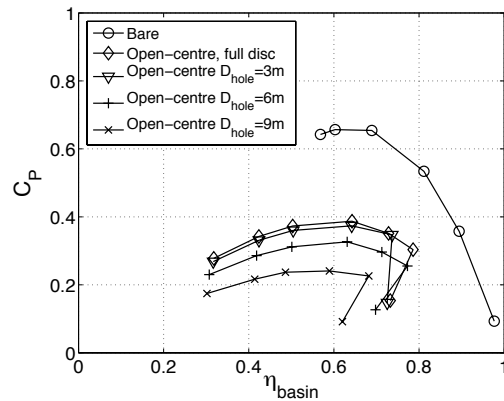

Fig. 3. Performance of the open-centre turbine.

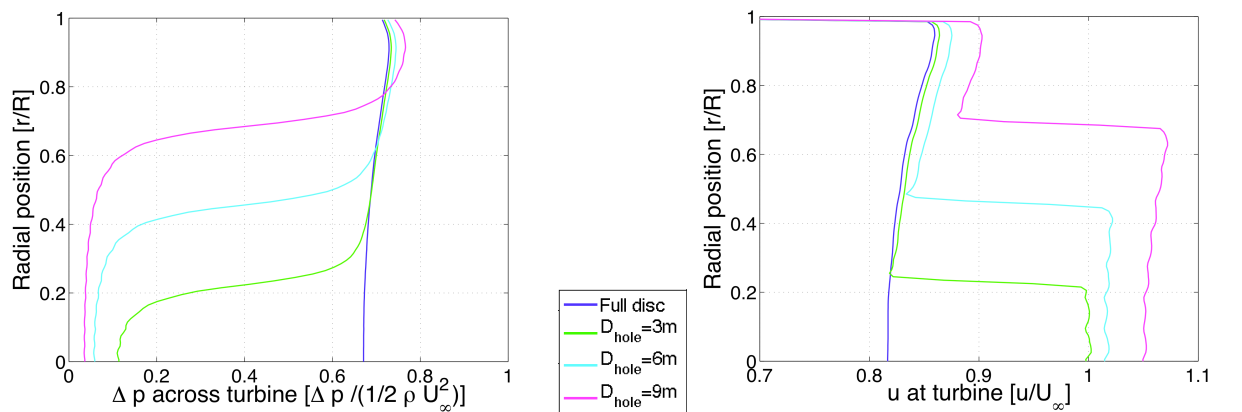

Fig. 2. Velocity and pressure jump profiles plotted against the radial position for the open-centre turbine with varying opening diameters at the maximum power point for each device.

Evaluation of FVNS Solvers for Structures in Tidal Flow

Robert Stringer*, Jun Zang

Department of Architecture & Civil Engineering, University of Bath, BA2 7AY, UK

Summary: In an attempt to accurately predict the von Kármán vortex shedding and associated forces of a cylindrical structure subject to tidal flow, a numerical environment is proposed and tested using two prominent Finite Volume Navier-Stokes (FVNS) solvers. The methodology has been developed through extensive literary exploration and iterative testing with the aim of generating an accessible means of analysis and to compare the solvers by closely matching the setup environments. A second study on cross-flow tidal turbine performance is also ongoing; although this is not discussed here, presentation of preliminary results at the workshop is intended.

Introduction

Over a full tidal cycle, realistic cylindrical supporting structures for marine energy applications, such as monopoles, can experience flows equivalent to Reynolds numbers (Re) from zero up to supercritical values. At the majority of flow speeds, undesirable fluctuating lift and drag forces are generated often referred to as Vortex Induced Vibrations (VIV). Accurate capture of the effects of VIV can aid both structural and turbine performance optimisation. Therefore, the study here aims to develop an effective testing methodology, comparing the solvers ANSYS® CFX-13.0 and OpenFOAM® 1.7.1 at test points throughout the full range of tidal conditions, from a Reynolds number of 40 up to 10^6 .

The study of flow around circular cylinders has been popular amongst academics with notable contributions from Roshko [1] and Achenbach and Heinecke [2] providing crucial experimental data. Numerical efforts often focus on specific Reynolds values, with effective turbulence modelling central to the success of the studies. Although many papers are considered, Tutar and Holdø [3] and Benim et al [4] are examples containing valuable results regarding geometry, meshing resolution and turbulence model selection. The literature analysis provided sufficient data to devise a proposed optimum scheme that is applied to all turbulent cylinder cases.

Computational Method

Due to the high Re values in the study requiring prohibitively large grids, 2D meshes were used throughout. An Unsteady Reynolds-Averaged Navier-Stokes (URANS) model is chosen over LES due to the applicability of LES being questionable in 2D and evidence of only marginal improvement over two-equation turbulence models. Turbulence was modelled using the Shear Stress Transport (SST) two equation model [5], chosen due to a proven accuracy in predicting heavily separated flows. This was combined with a robust Low-Re boundary meshing strategy, body fitted near wall cells and aspect ratio control. More specifically, the meshes were iteratively derived such that a $y^+ < 1.5$ was guaranteed, allowing the SST model to predict flux gradients within the boundary layer as opposed to the standard logarithmic wall model. In practice this was achieved differently between the two codes; CFX employs a Low-Re formulation whereby the k-equation is artificially set to zero and the momentum flux is directly computed from velocity profile, shear stress includes a function of viscous and logarithmic values and ω is calculated by an algebraic expression. Conversely, OpenFOAM does not include such a formulation in the distribution being tested, therefore a continuous wall model by Spalding is applied where a single function is iteratively solved which describes a “universal” velocity profile from laminar to logarithmic layer; interestingly the Spalding wall model is the default method provided by OpenFOAM for LES computations where a wall model is desired.

* Corresponding author.

Email address: r.m.stringer@bath.ac.uk

Results

Results were extracted for key parameters including lift and drag components, Strouhal number, boundary layer thickness, pressure and velocity distribution, wake dimensions and more. An example result is presented in Fig. 1. depicting the drag coefficient versus Re for a smooth cylinder; data includes experimental values from Zdravkovich [6] and Massey [7] and computed from CFX and OpenFOAM. Although only drag coefficient is displayed here, it is representative of the quality of the results more generally; low and subcritical Re values are modelled with high success by OpenFOAM, while force terms in upper critical and supercritical flows are better predicted by CFX.

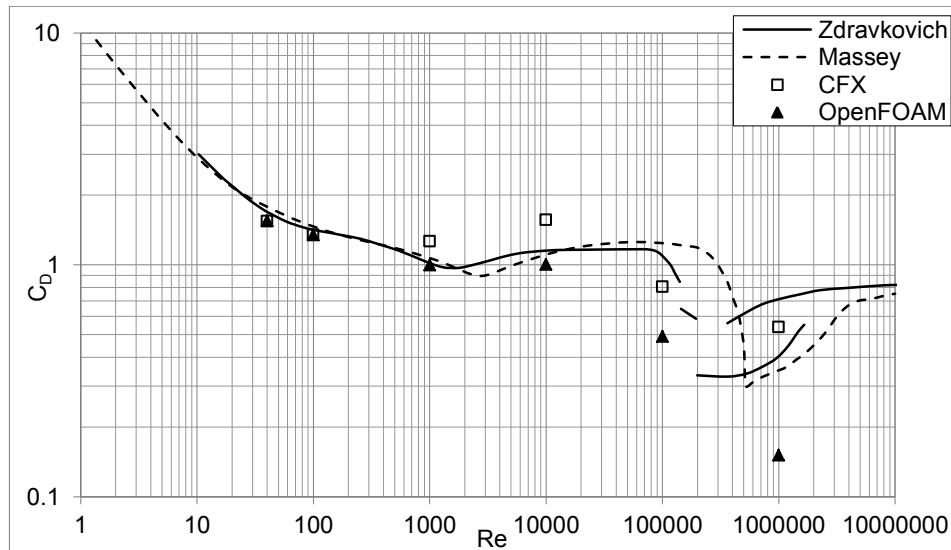

Fig. 1. Graph of flow Reynolds number vs. Coefficient of Drag

Conclusions

The modelling of an essentially 3D problem in 2D is a common simplification in an effort to reduce run times and increase productivity. The results of the 2D URANS method developed here show some significant achievements particularly up to the higher subcritical region $Re < 10000$, this may be extended up to $Re = 10^5$ with further testing with results being suitable for engineering purposes. Further study of the results may also shed light on the discrepancy between the solvers despite efforts to closely match the numerical environments such as common meshes and governing parameters.

References:

- [1] Roshko, A., *On the Wake and Drag of Bluff Bodies*. Journal of the Aeronautical Sciences, 1955. **22**(2): p. 124-132.
- [2] Achenbach, E. and E. Heinecke, *On Vortex Shedding from Smooth and Rough Cylinders in the Range of Reynolds-Numbers 6×10^3 to 5×10^6* . Journal of Fluid Mechanics, 1981. **109**(Aug): p. 239-251.
- [3] Tutar, M. and A.E. Holdo, *Computational modelling of flow around a circular cylinder in sub-critical flow regime with various turbulence models*. International Journal for Numerical Methods in Fluids, 2001. **35**(7): p. 763-784.
- [4] Benim, A.C., et al., *RANS predictions of turbulent flow past a circular cylinder over the critical regime*. Proceedings of the 5th Iasme/Wseas International Conference on Fluid Mechanics and Aerodynamics (Fma '07), 2007: p. 235-240.
- [5] Menter, F.R., *2-Equation Eddy-Viscosity Turbulence Models for Engineering Applications*. Aiaa Journal, 1994. **32**(8): p. 1598-1605.
- [6] Zdravkovich, M.M., *Conceptual Overview of Laminar and Turbulent Flows Past Smooth and Rough Circular-Cylinders*. Journal of Wind Engineering and Industrial Aerodynamics, 1990. **33**: p. 53-62.
- [7] Massey, B.S., *Mechanics of fluids*. 6th ed. ed. 1989: Van Nostrand Reinhold. [608]p.

On the Garrett & Cummins limit

Thomas A.A. Adcock

Department of Engineering Science, University of Oxford, OX1 3PJ, UK

Summary: Garrett & Cummins derived a limit to the energy that may be extracted from an idealised tidal channel. In this note we show that this limit may be exceeded if the drag coefficient of a turbine is allowed to vary with time. We also consider how the limiting energy may be practically extracted using actuator disc theory and again find increased energy is available than previously reported.

Introduction

Garrett & Cummins [1] used a simple model for the flow in a tidal channel connecting two basins. Whilst the model involves a major simplification of the tidal dynamics of a real channel, it is nevertheless valuable for gaining understanding of the problem of extracting energy from a tidal stream. The model assumes a tidal channel linking two bodies of water whose water levels are independent of the flow in the channel. The flow in the channel is then dependent on the difference in the water level (assumed sinusoidal), the drag in the channel due to bed friction and turbines, and the inertia of the water. After non-dimensionalisation (see [1]) this gives the equation

$$\frac{dQ'}{dt'} = \cos(t') - (\lambda_0 + \lambda_1)Q'|Q'| \quad (1)$$

where Q' is the non-dimensional flow rate, t' non-dimensional time, and λ_0 and λ_1 the non-dimensional drag components due to the channel friction and the presence of turbines. Realistic values for λ_0 are roughly between 0.4 and 4. Garrett & Cummins found the limit for the maximum power that may be extracted from such a channel to be remarkably insensitive to the channel properties (λ_0), when the power output was normalised by density, driving amplitude, the naturally occurring peak flow rate, and gravitational acceleration (all results in this note are presented normalised by these variables). The Garrett & Cummins limit represents the maximum power that may be extracted by a channel. In reality, the amount of power that can be utilised for useful work is rather smaller than the limiting value due to mixing behind the turbine, viscous turbine losses, generator losses, etc. The mixing losses may be captured using an actuator disc model, with the wake induction factor “tuned” so that maximum useful work is extracted [2].

Power extracted from the flow

The Garrett & Cummins analysis assumed that the drag coefficient, and hence λ_1 was constant. In practice, this could vary as, say, a turbine is operated at different tip-speed-ratios. We therefore allow λ_1 to vary with time. As the model is periodic we assume that the optimum form of λ_1 can be decomposed into harmonics of the driving frequency allowing us to write

$$\lambda_1(t') = \sum_{n=0}^N \Lambda_n \cos(nt' + \phi_n) \quad (2)$$

where Λ and ϕ are unknown coefficients and N the number of components used in the analysis. We search for the values of these which will give maximum power extraction using an optimisation routine, imposing the condition that at all times λ_1 must be positive (i.e. the turbines cannot be switched to act as a pump). Equation 1 is solved using a 4th order Runge-Kutta time-stepping scheme. Due to the symmetric nature of the flow, odd harmonics in Equation 2 do not lead to an increase in the maximum power output. However, even harmonics do lead to an increase in the available power. This is small for channels where λ_0 is large — the analysis of these is quasi-steady and so introducing a time varying component would not be expected to yield increased energy. However, for channels with small λ_0 a substantial increase in power extracted is possible. This is shown in Figure 1 for different

numbers of harmonics. It can be seen that the solution appears to be converging as more components are used.

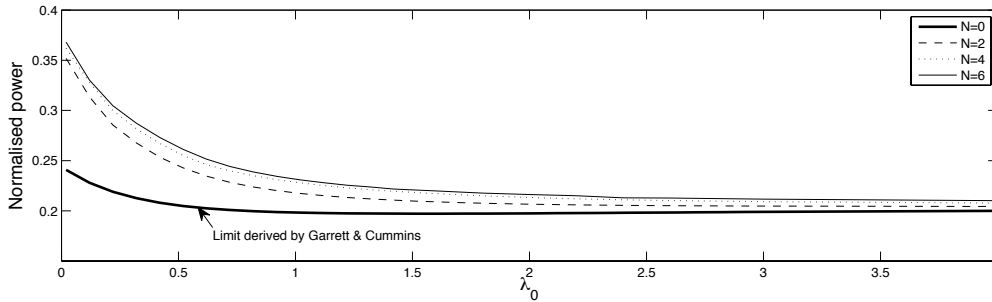

Figure 1 Energy that may be extracted from a channel with different numbers of components.

Useful energy available

An upper limit for the useful energy available may be derived by using an actuator disc model in the channel to calculate λ_1 and the power output. To maximise power output, the wake induction factor of the turbines needs to be “tuned” [2]. In this analysis we use the turbine model of Garrett & Cummins [3]. Whilst this is valid only for small Froude number, for realistic channels we find negligibly different results when the finite Froude number model [4] is used. We assume the optimum wake induction factor has sinusoidal components in the same manner as Equation 2 and a routine is run to find these. We consider only one row of turbines — multiple rows may be accounted for by dividing λ_0 by the number of rows. Figure 2 shows the available power for two different blockage ratios. $N=0$ corresponds to the analysis of Vennel (see his Fig. 7b).

Conclusions

We have shown that it is possible to extract more power from an idealised channel than the limit introduced by Garrett & Cummins and also that more of this may be utilised than given in the analysis by Vennel.

References:

- [1] Garrett, C., Cummins, P. (2005). The power potential of tidal currents. *Proc. R. Soc. A.* **461** 2563-2572
- [2] Vennel, R. (2010) Tuning turbines in a tidal channel. *J. Fluid Mech.* **663**, 253-267.
- [3] Garrett, C., Cummins, P. (2007). The efficiency of a turbine in a tidal channel. *J. Fluid Mech.* **588**, 243–251.
- [4] Housby, G. T., Draper, S., Oldfield, M. L. G. (2008). Application of linear momentum actuator disc theory to open channel flow. *Report No. OUEL 2296/08*, Department of Engineering Science, University of Oxford.

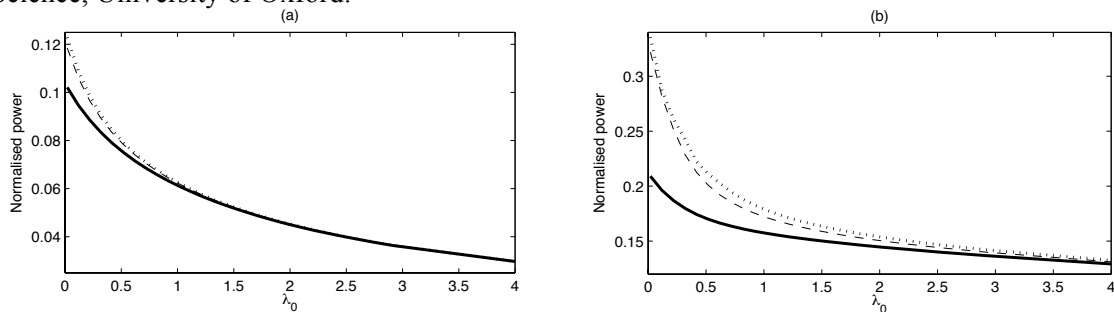

Figure 2 Useful power available. (a) blockage=0.4; (b) blockage=0.8. Thick line — $N=0$; dash — $N=2$; dots — $N=4$

Workshop Attendees

Adcock, Thomas	University of Oxford
Belloni, Clarissa	University of Oxford
Buckland, Hannah	Swansea University
Cheong, Sei Him	Swansea University
Drake, Kevin	University College London
Eatock Taylor, Rodney	University of Oxford
Evans, Paul	Cardiff University
Fernandez Rodriguez, Emmanuel	University of Manchester
Ferrer, Esteban	University of Oxford
Fleming, Conor	University of Oxford
Graham, Michael	Imperial College London
Houlsby, Guy	University of Oxford
Hunter, William	University of Oxford
Jeffcoate, Penelope	University of Manchester
Johnson, Peter	University College London
Malki, Rami	Swansea University
Mason-Jones, Allan	Cardiff University
Masters, Ian	Swansea University
McAdam, Ross	University of Oxford
McIntosh, Simon	University of Oxford
McNae, Duncan	Imperial College London
McNaughton, James	University of Manchester
Nishino, Takafumi	University of Oxford
Olczak, Alex	University of Manchester
Salter, Stephen	University of Edinburgh
Schluntz, Justine	University of Oxford
Sequeira, Carl	University of Cambridge
Serhadlioglu, Sena	University of Oxford
Stallard, Tim	University of Manchester
Stansby, Peter	University of Manchester
Stringer, Robert	University of Bath
Tabor, Gavin	University of Exeter
Taylor, Paul	University of Oxford
Togneri, Michael	Swansea University
Vogel, Christopher	University of Oxford
Vybulkova, Lada	University of Glasgow
Willden, Richard	University of Oxford
Zang, Jun	University of Bath
Zangiabadi, Enayatollah	Swansea University